

[44]

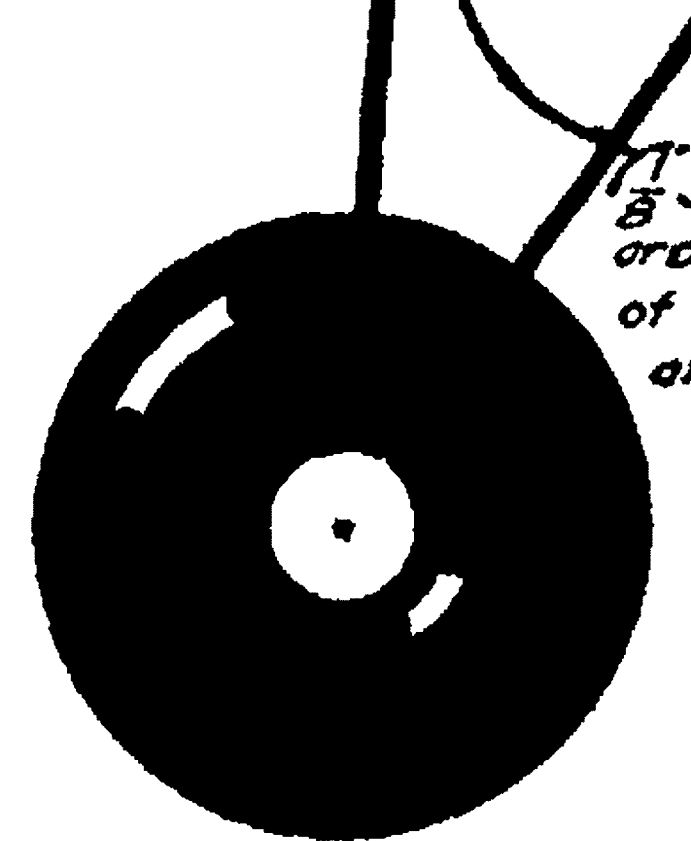

LANDING GEAR STRUTS
3/8" piano wire

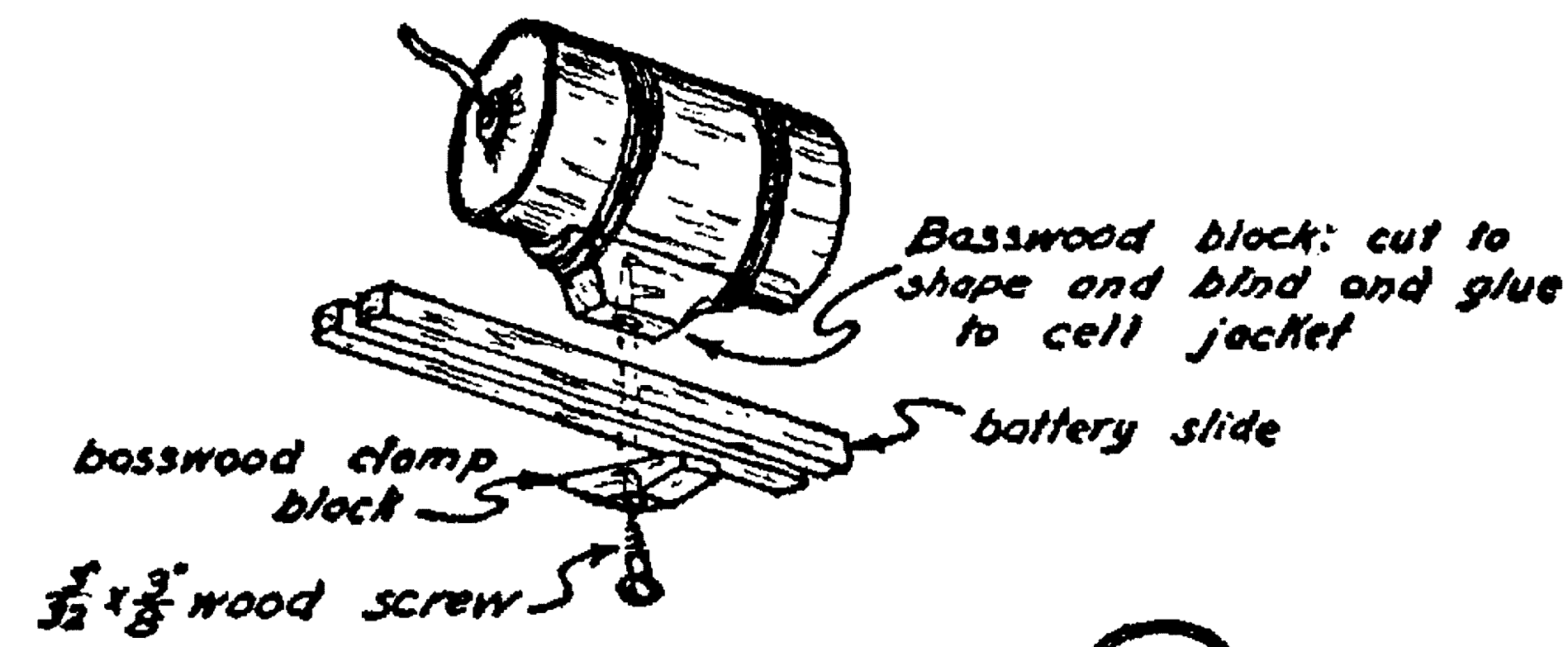
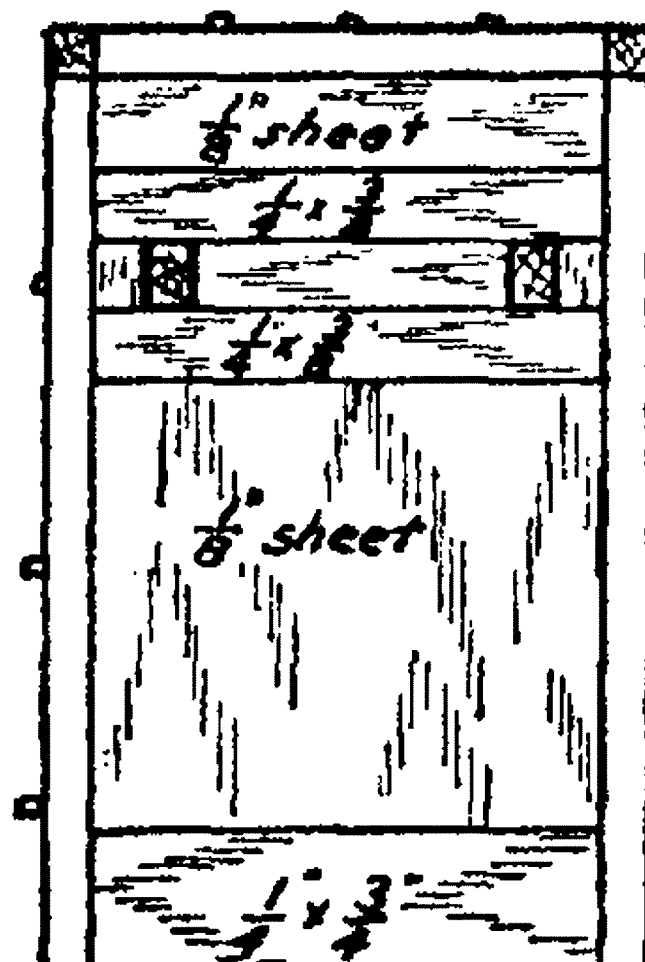
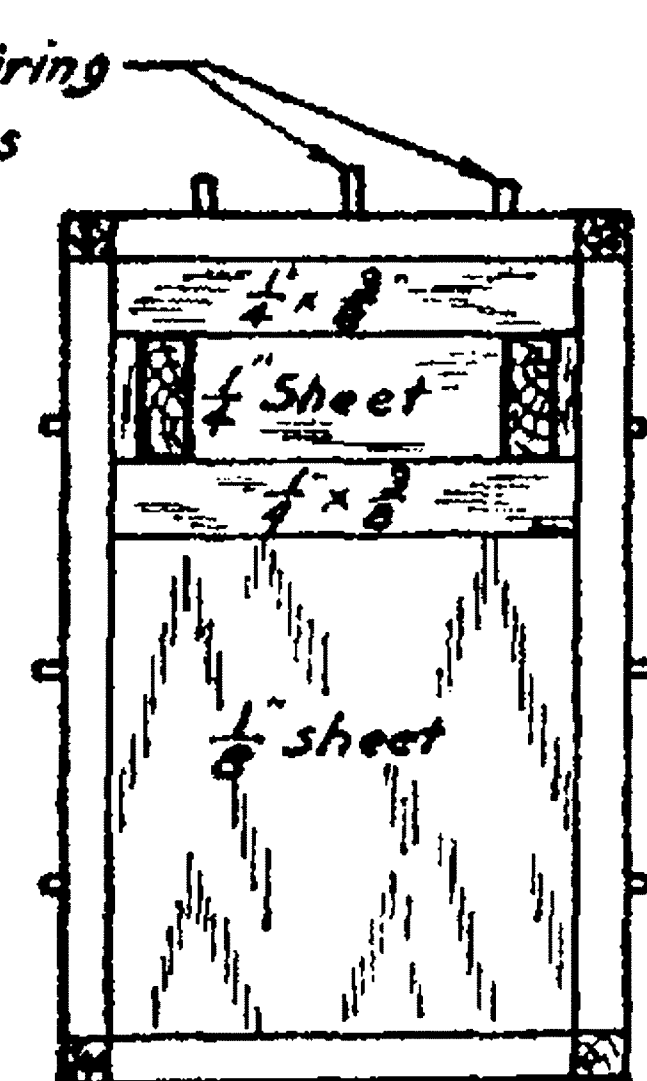
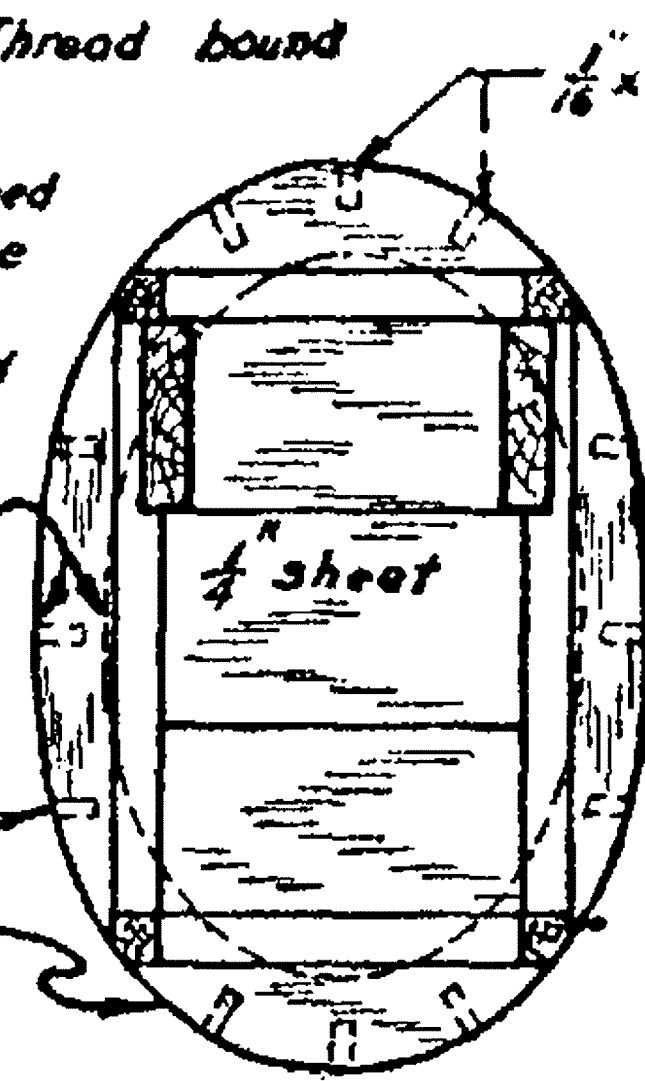

BATTERY MOUNT
Cells are mounted separately; They are renewed by inserting new cells in the mounted jackets.

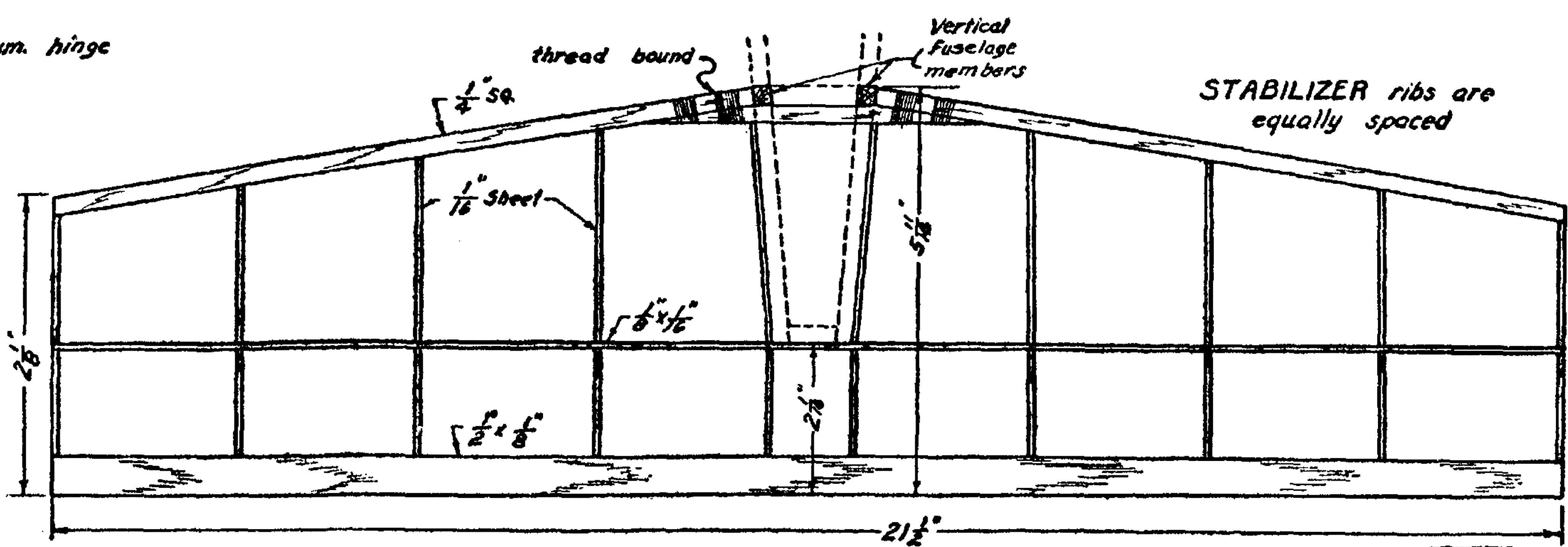
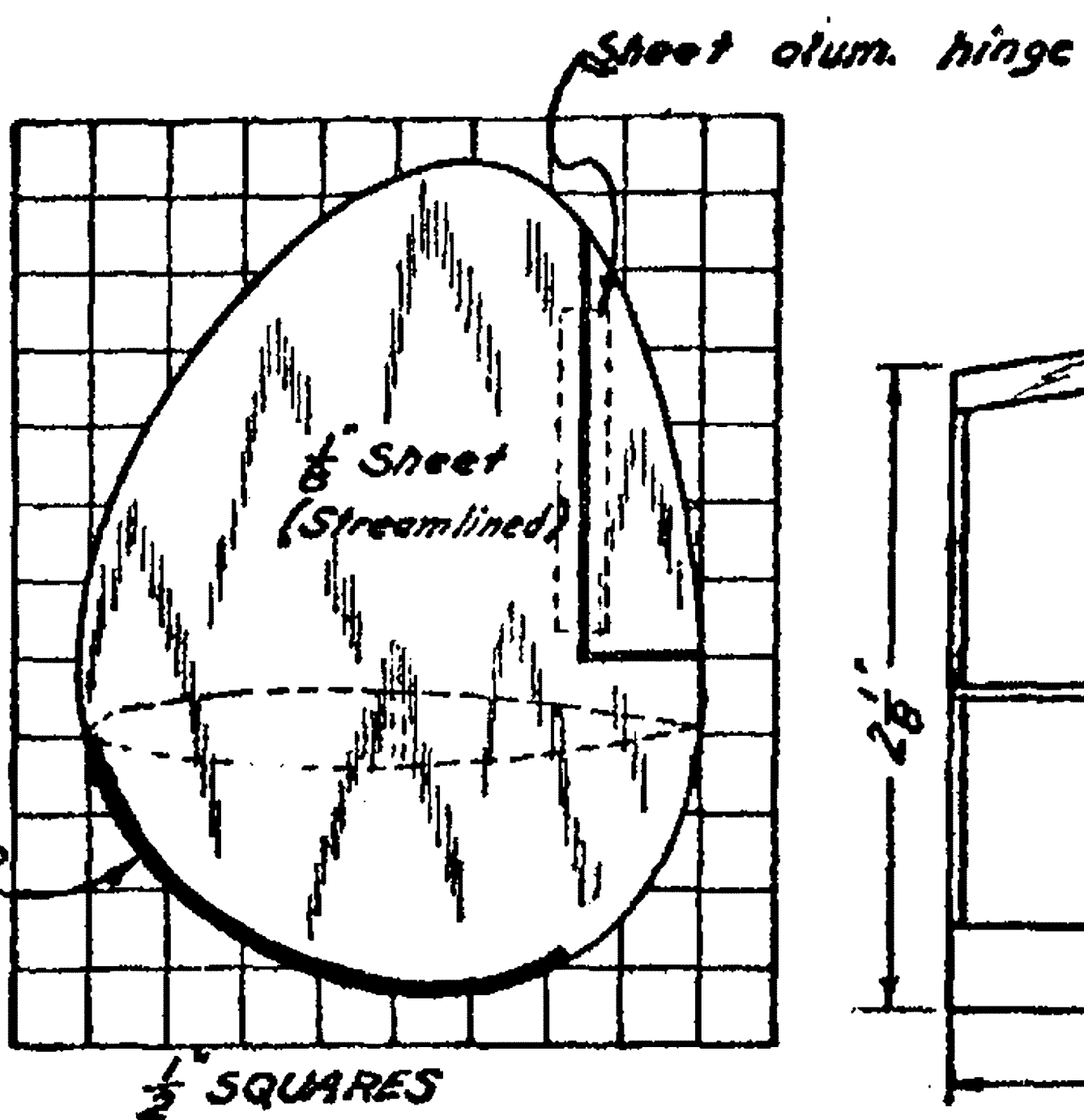
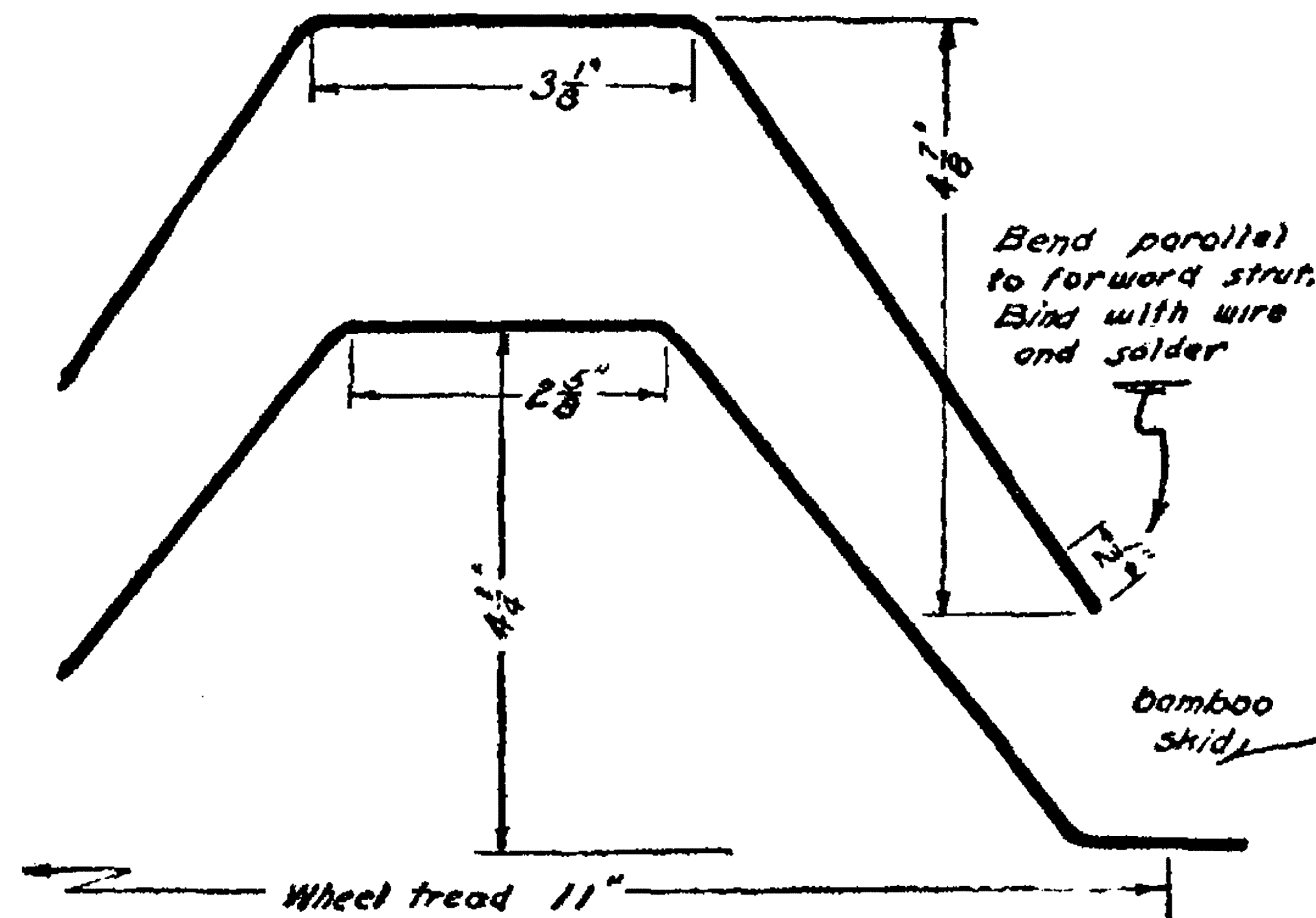
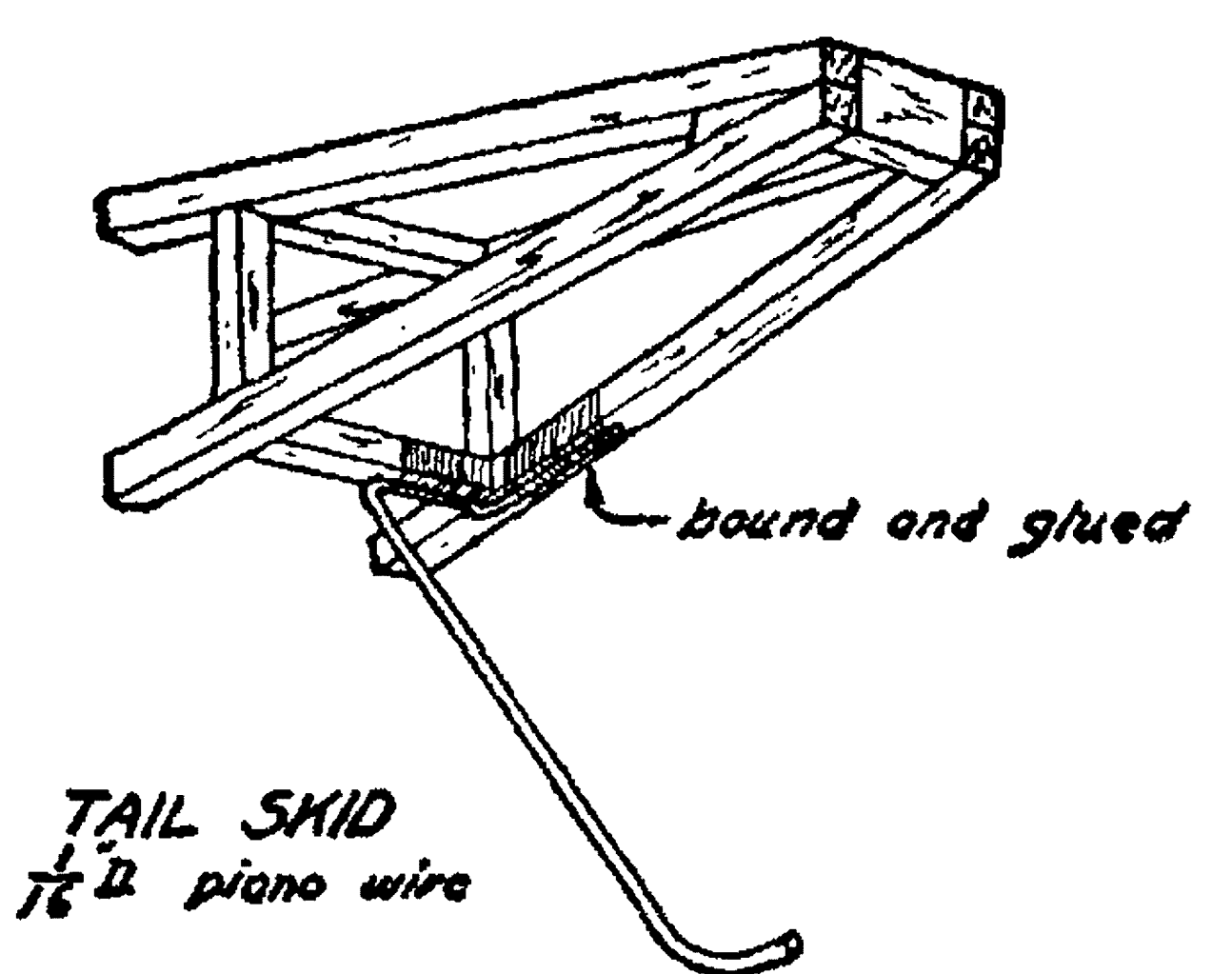
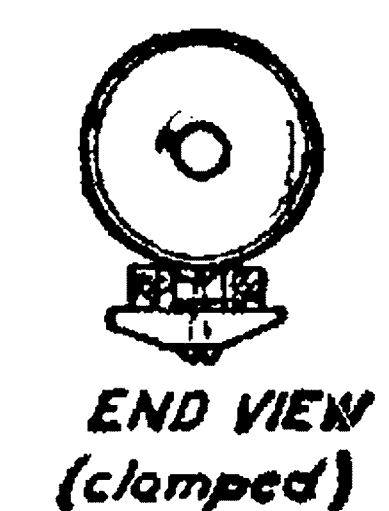

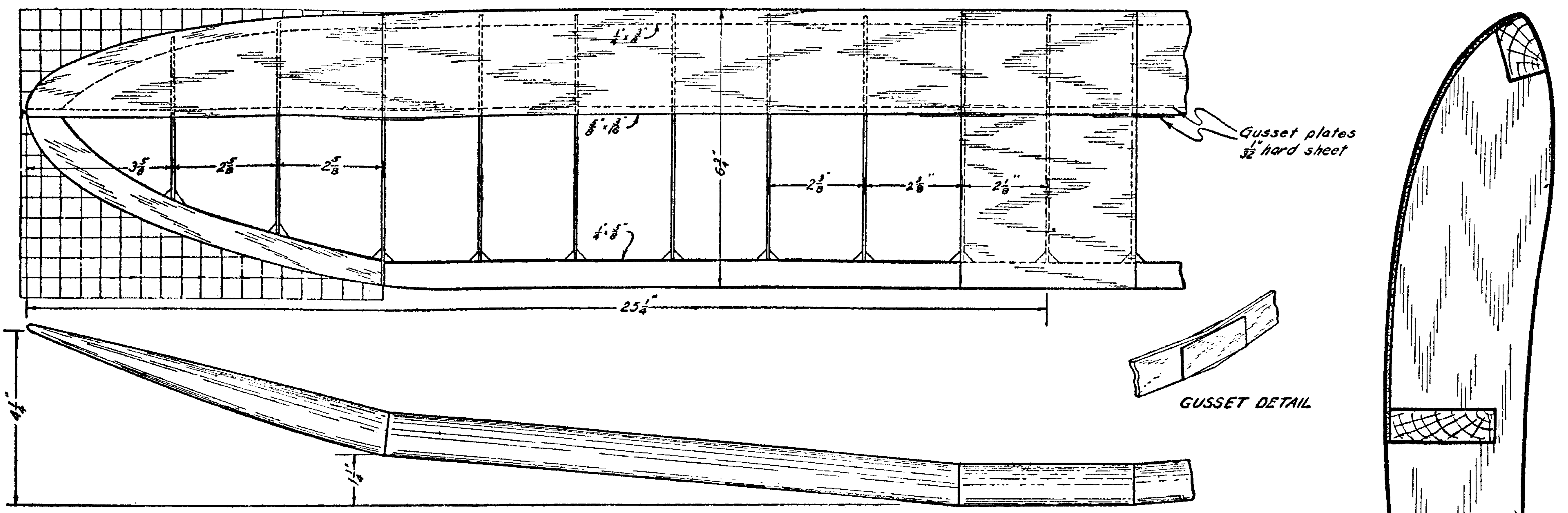

Wing is full size, see page three for full size rib

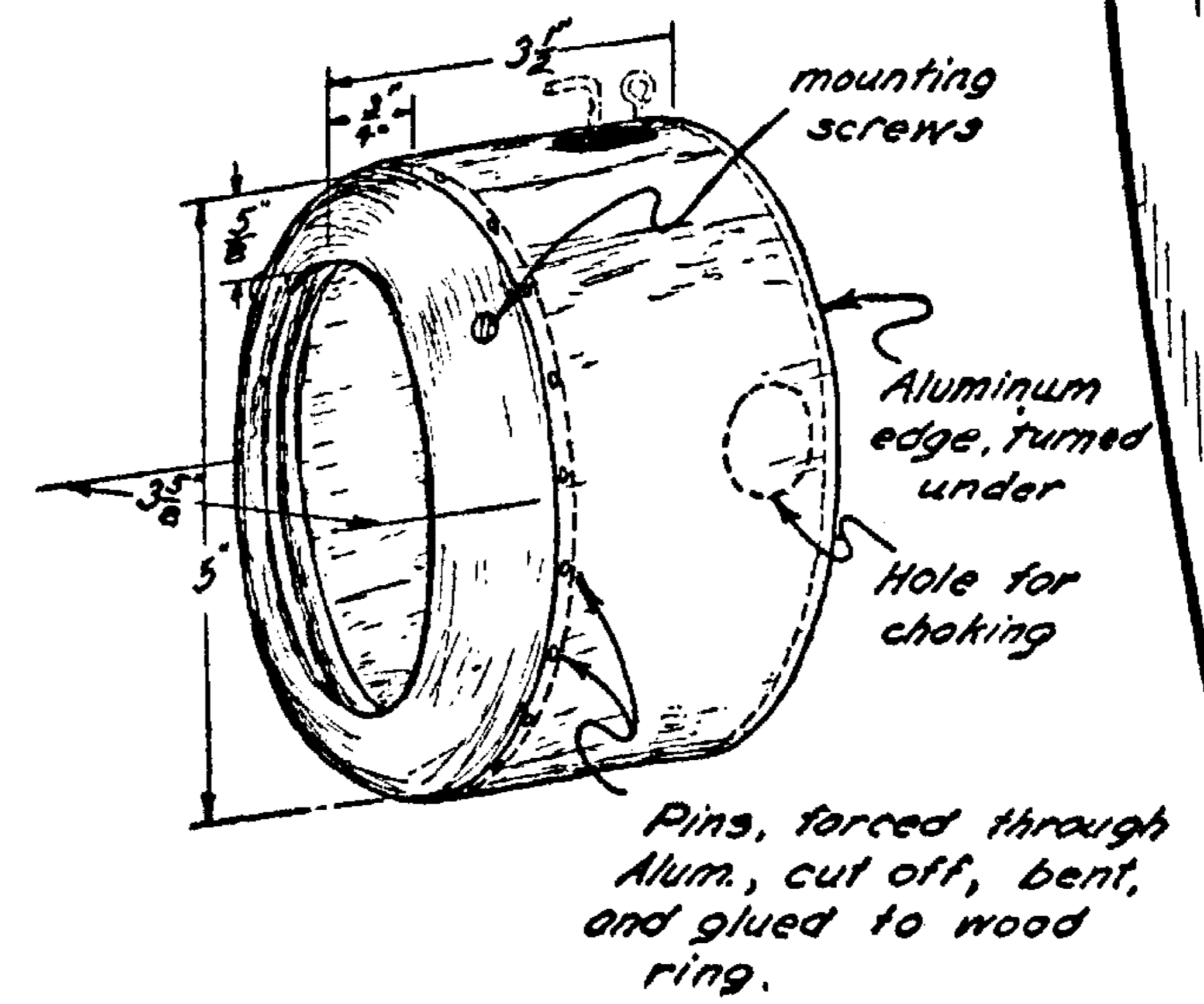
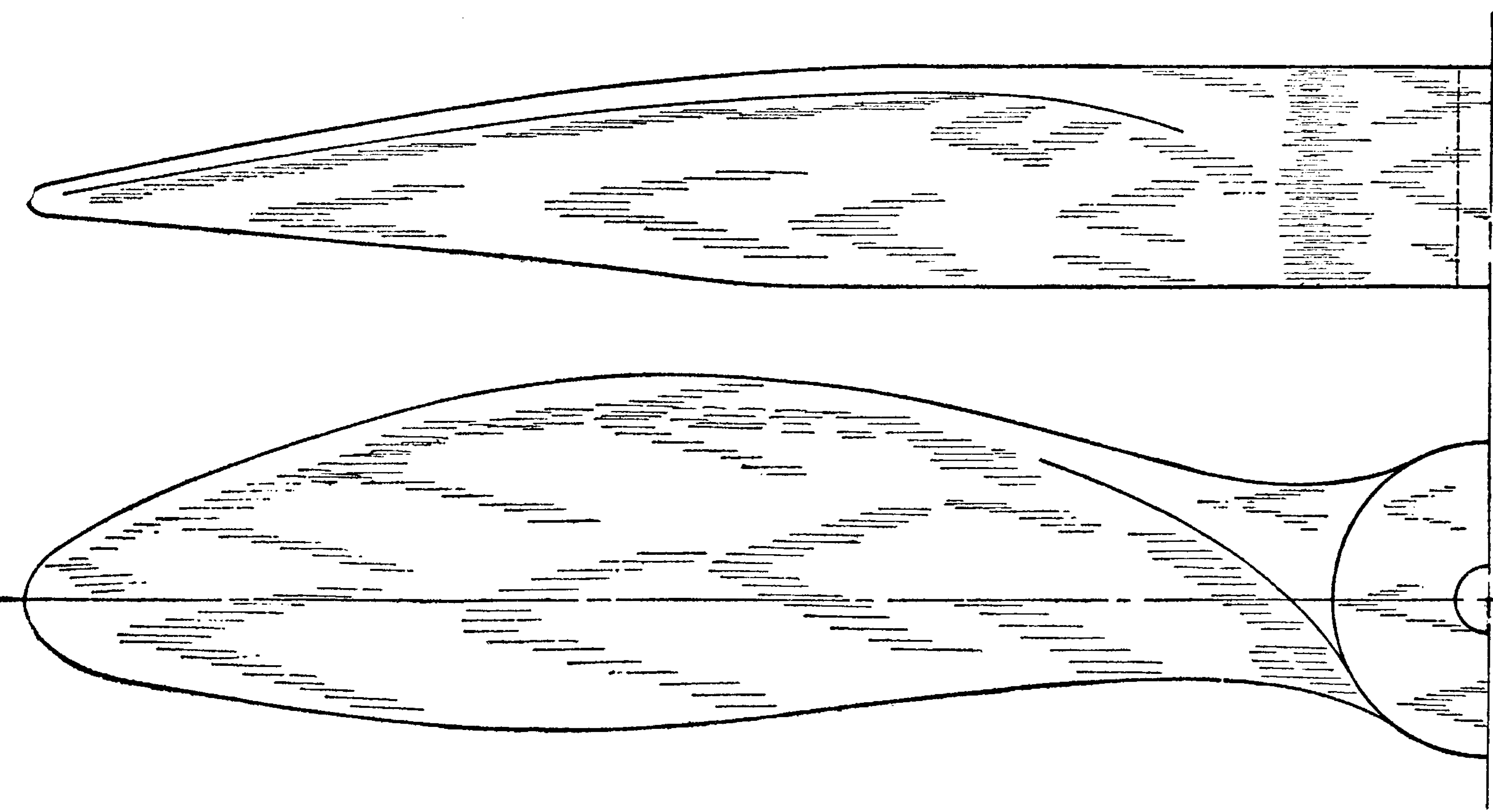

PROPELLER
(full size)
cut from blank 3/8" x 2" x 12"
(can be either left or
right turning according
to builder's preference.)

WING SECTION
(full size)

[45]

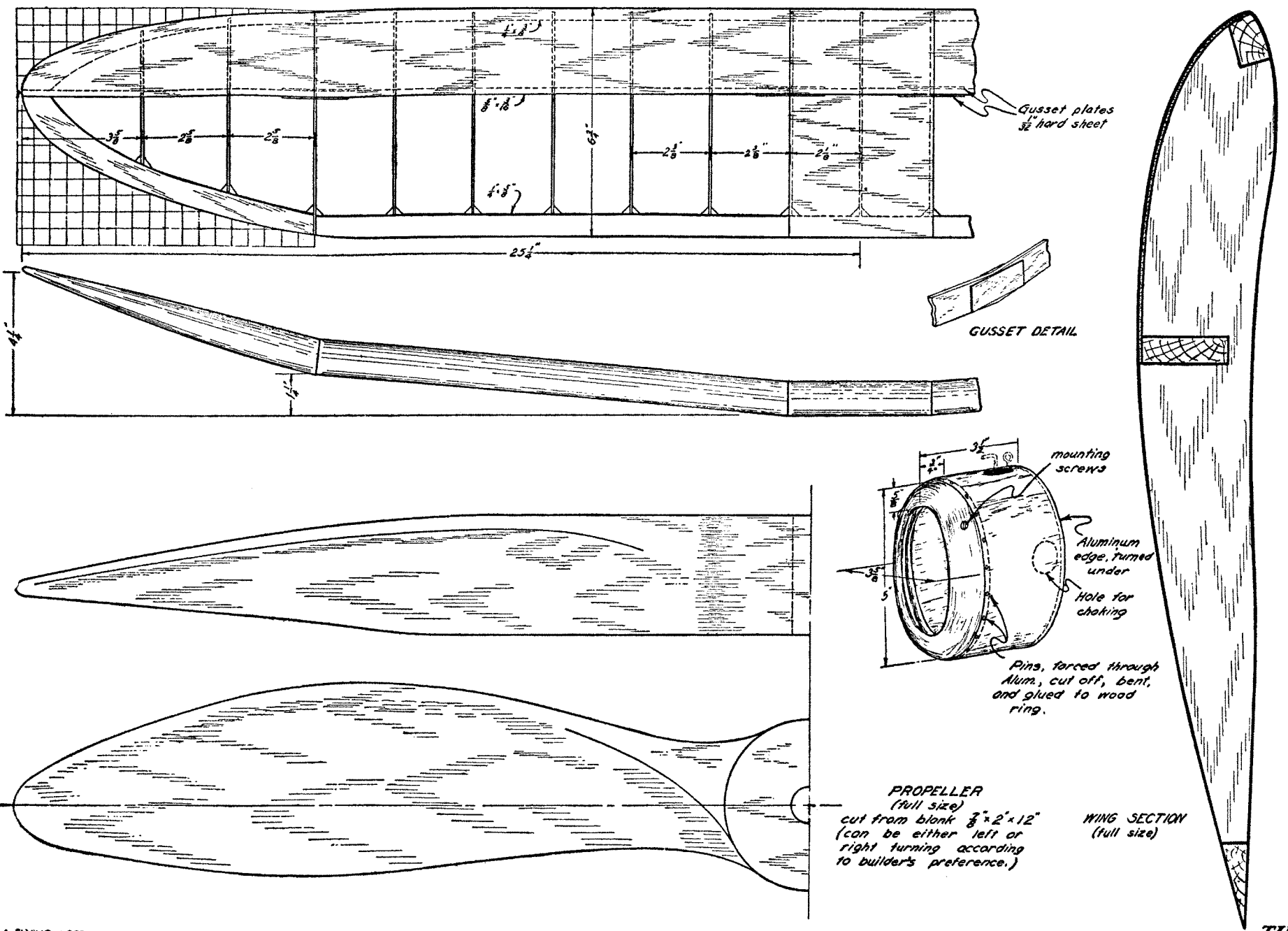

PROPELLER
(full size)
cut from blank 3/8" x 2" x 12"
(can be either left or
right turning according
to builder's preference.)

WING SECTION
(full size)

[45]