

BUILD WING, TAIL & FUSELAGE SIDES  
DIRECTLY OVER PLAN

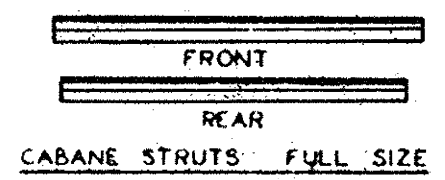

# DIPPER

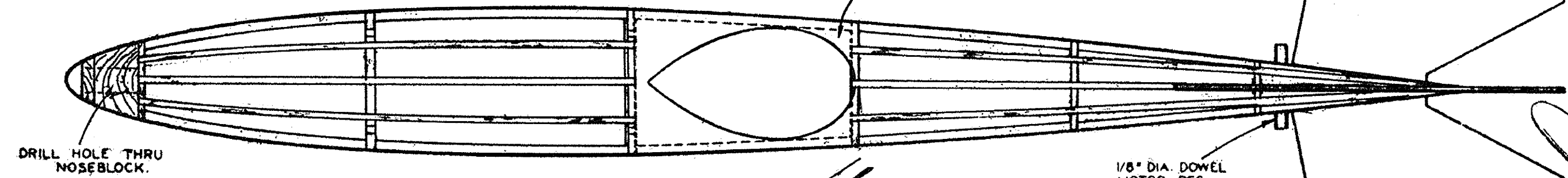
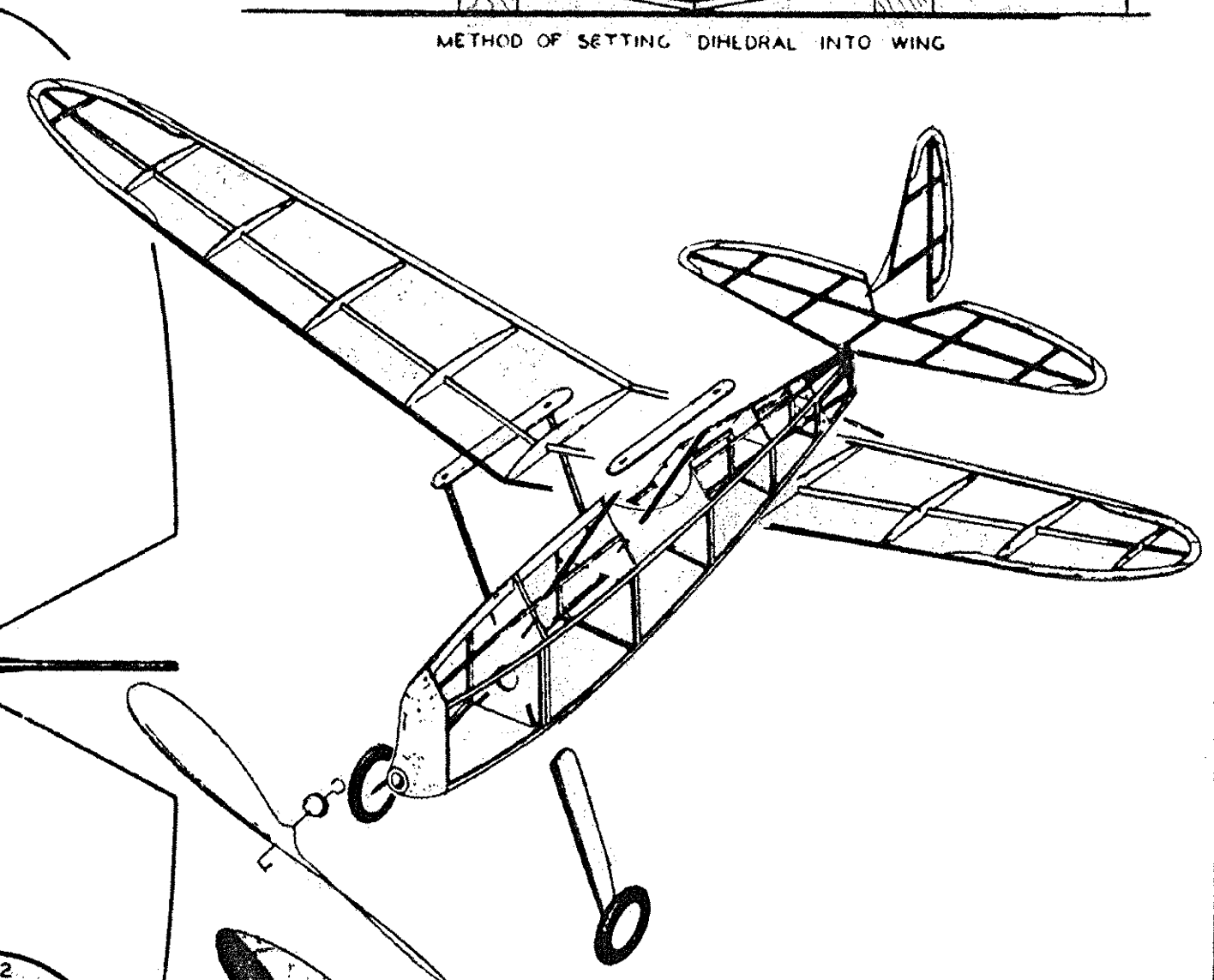
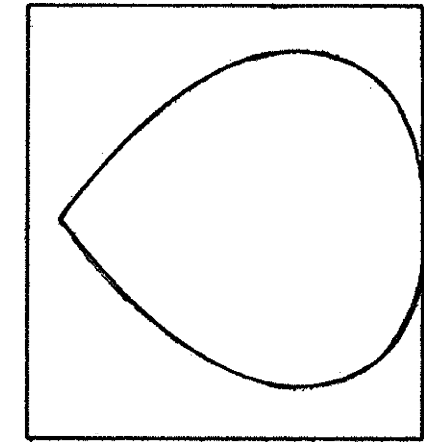
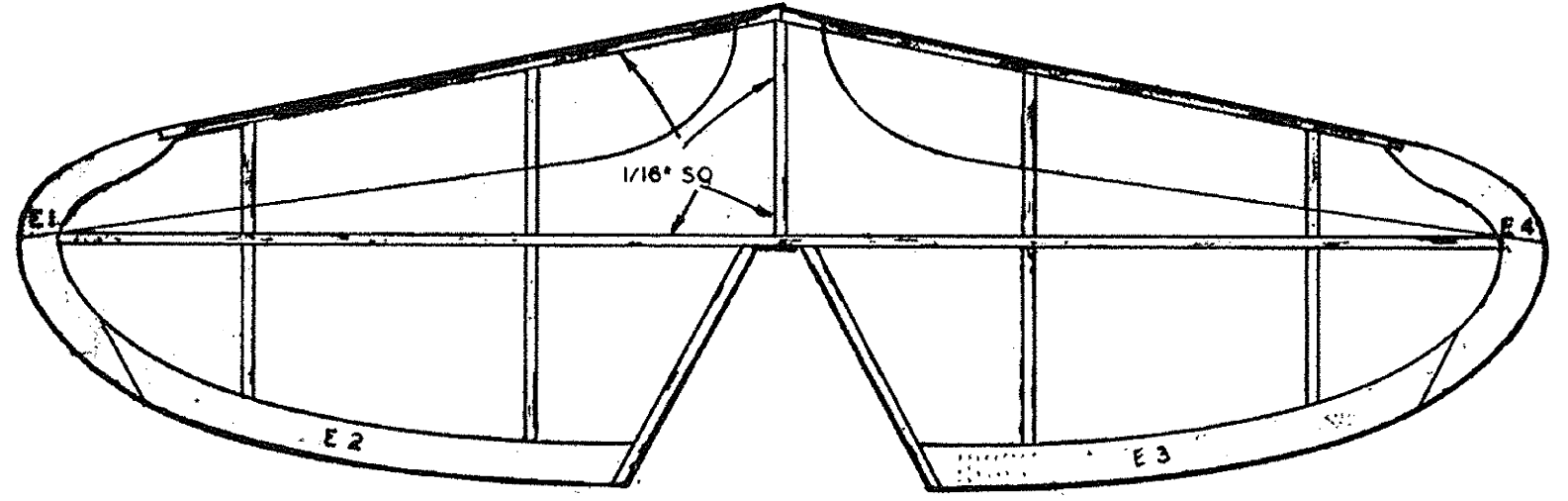
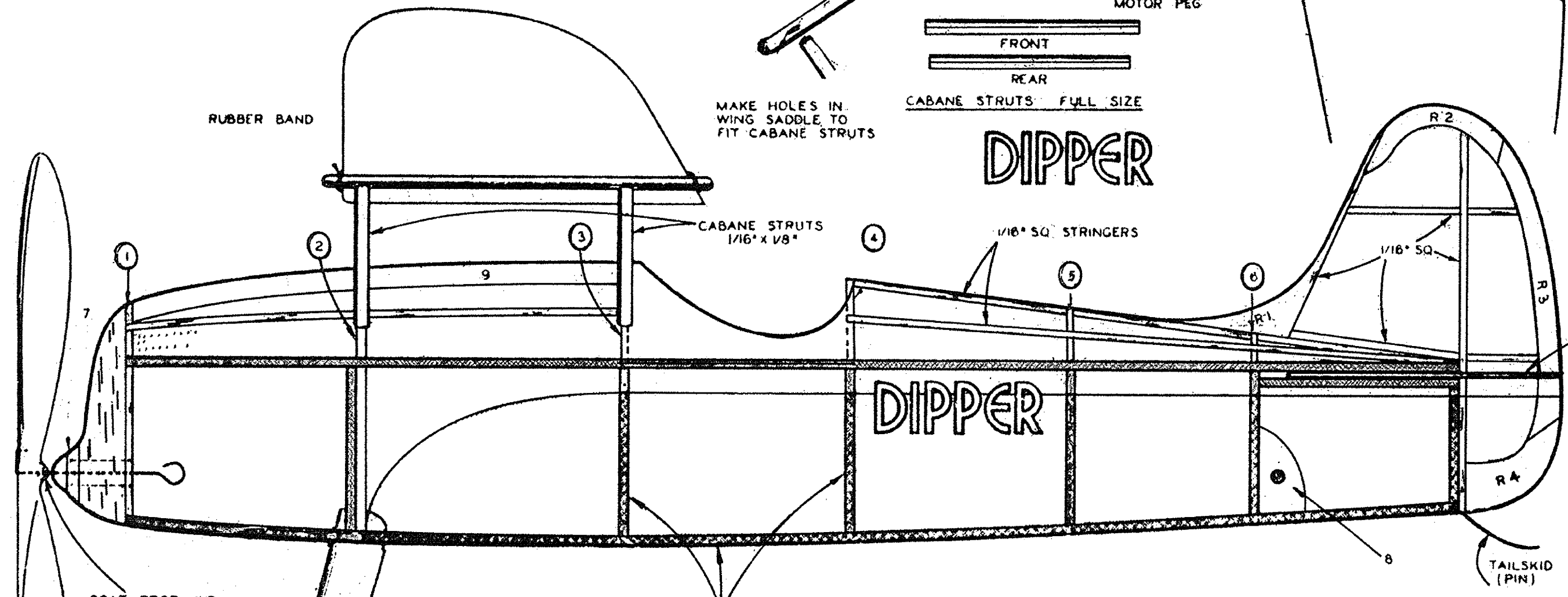

FIRST - LAY 3/32" SQ Balsa STRIPS  
OVER SHADED SECTIONS

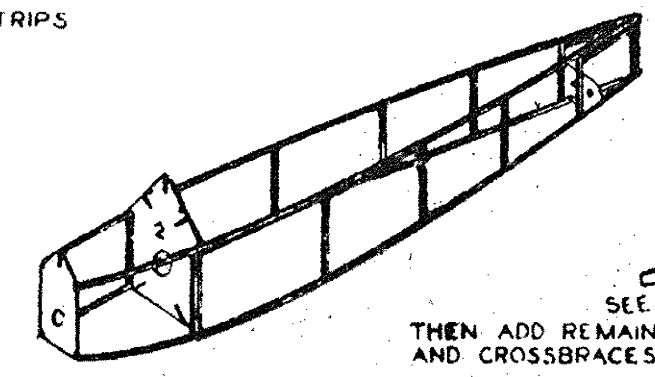
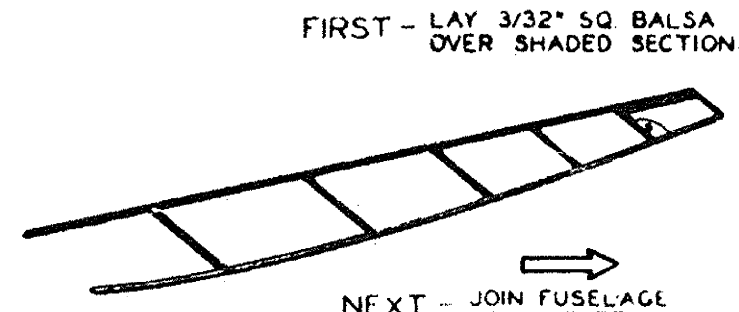

SEE EXPLODED VIEW



THE **DIPPER** KIT NO. L9  
DESIGNED & DRAWN BY  
Velo M. Garofalo

