

2mm PLY

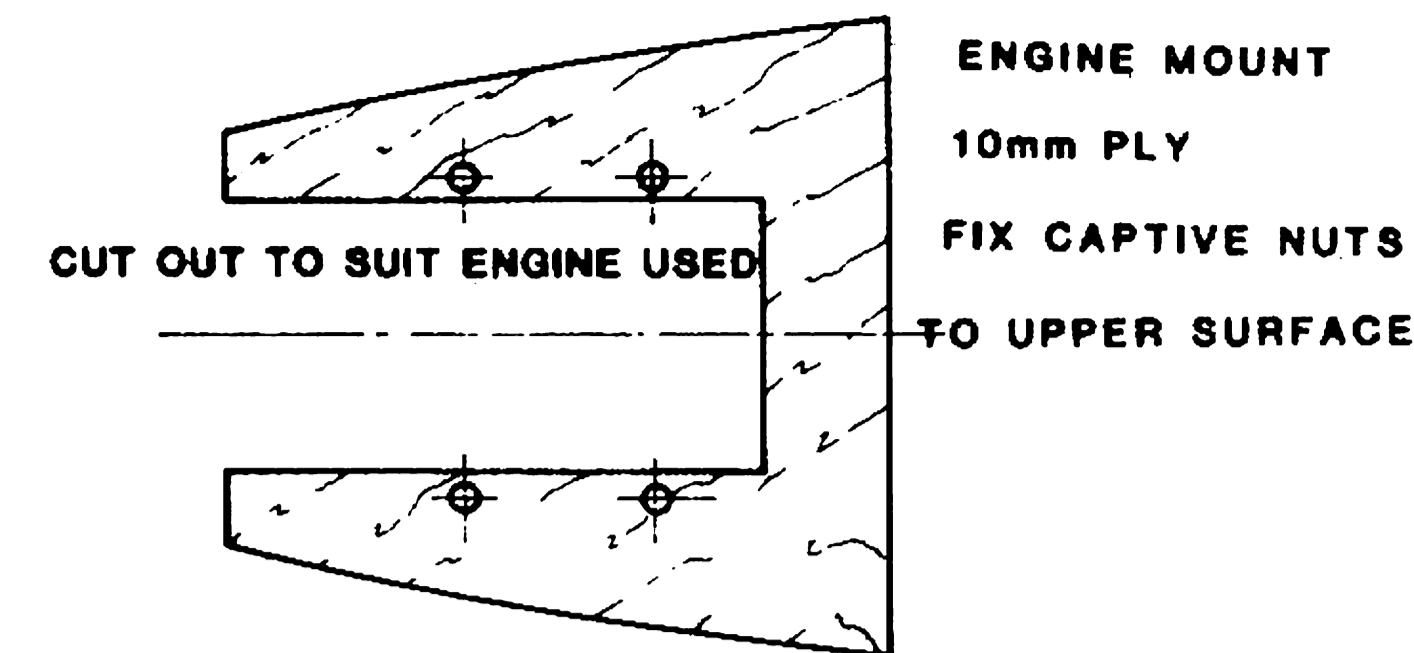

ENGINE MOUNT
10mm PLY
FIX CAPTIVE NUTS
TO UPPER SURFACE

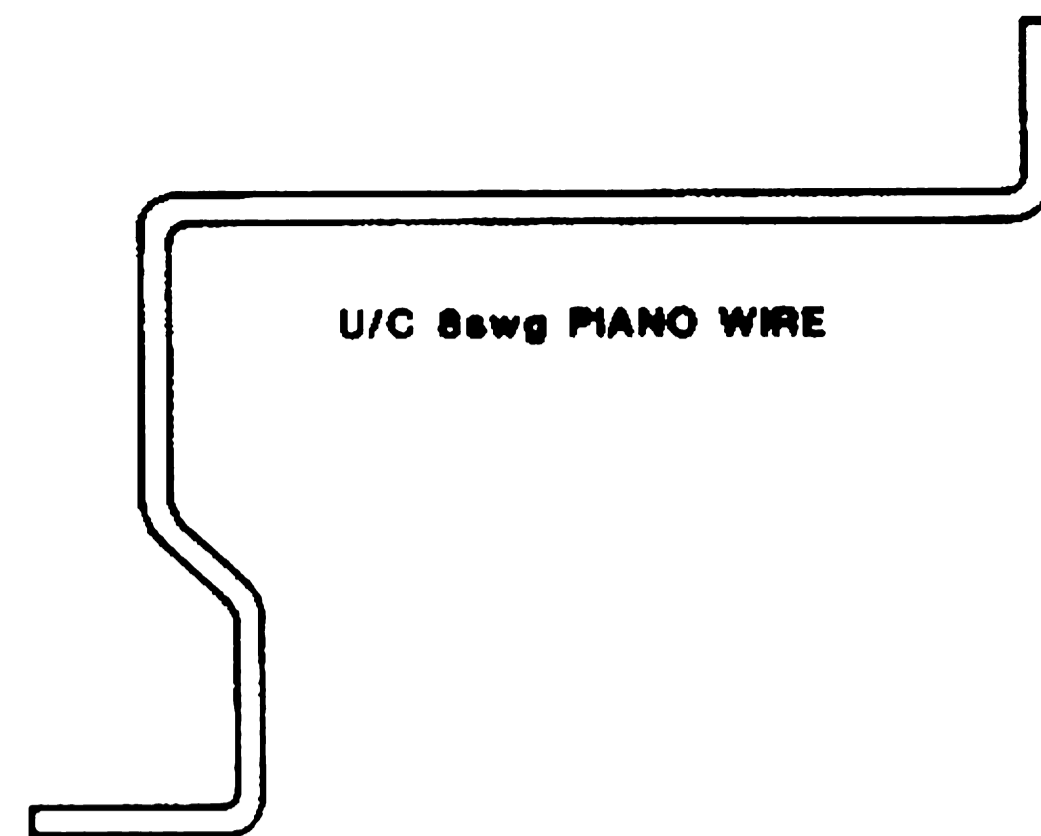

U/C 8wg PIANO WIRE



F2 3mm PLY
DRILL FOR FUEL LINES
& THROTTLE SNAKE

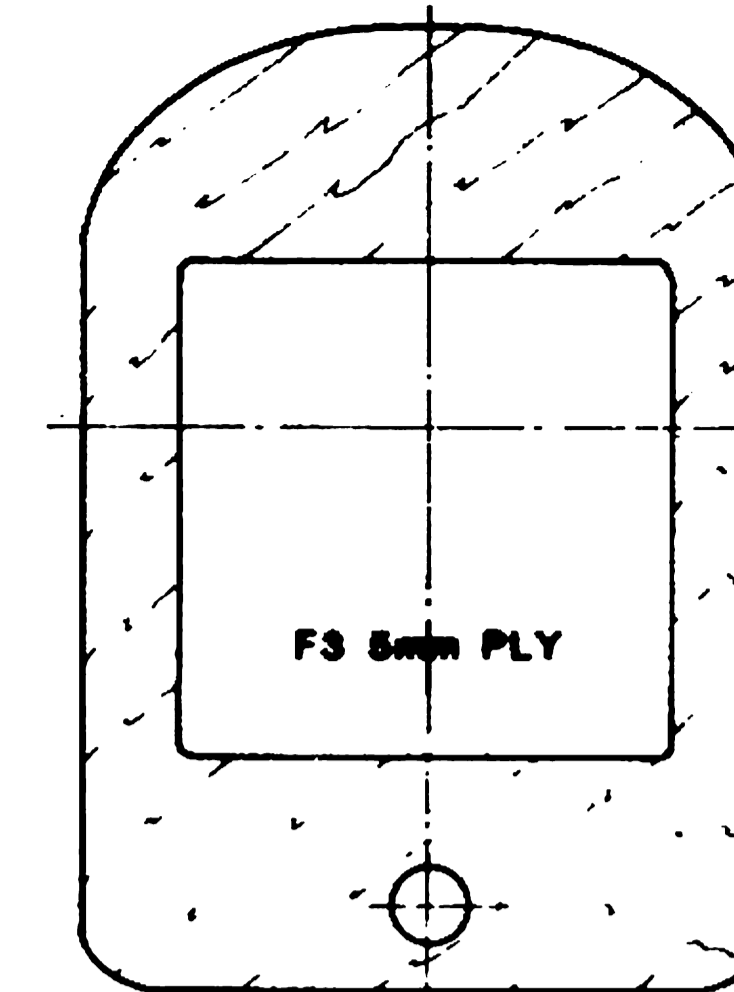

F3 3mm PLY

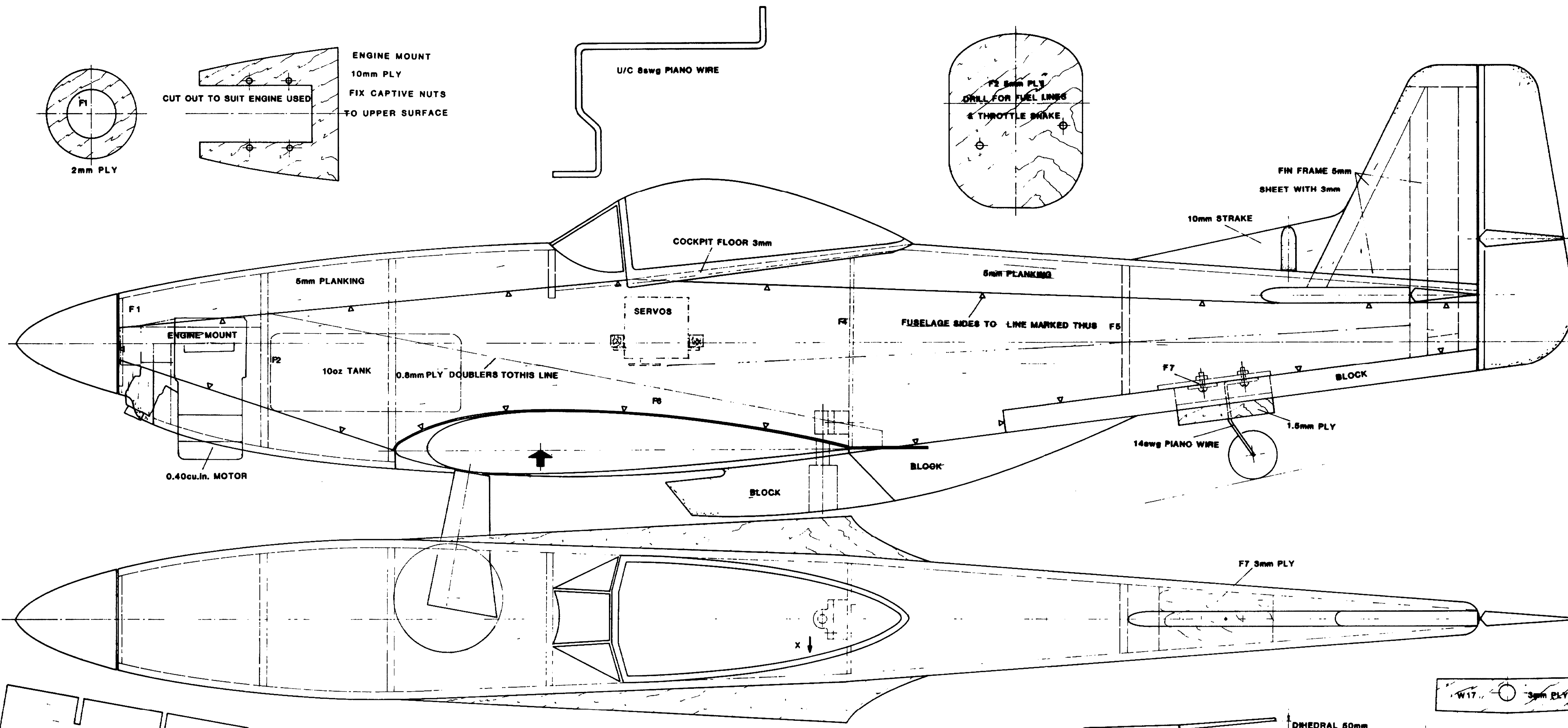

10mm SAND TO SECTION

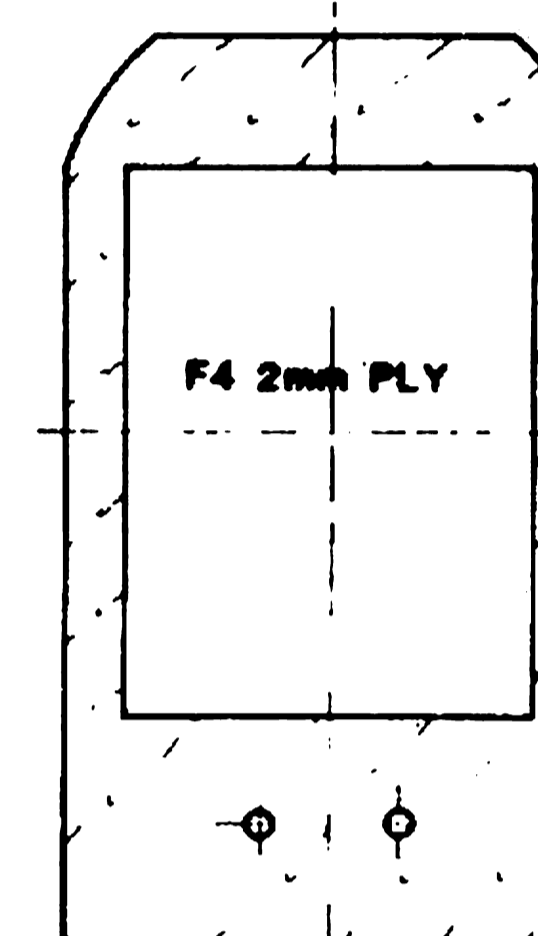

F4 2mm PLY

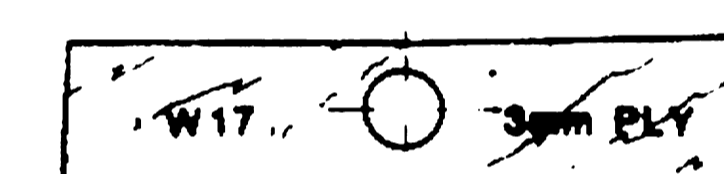
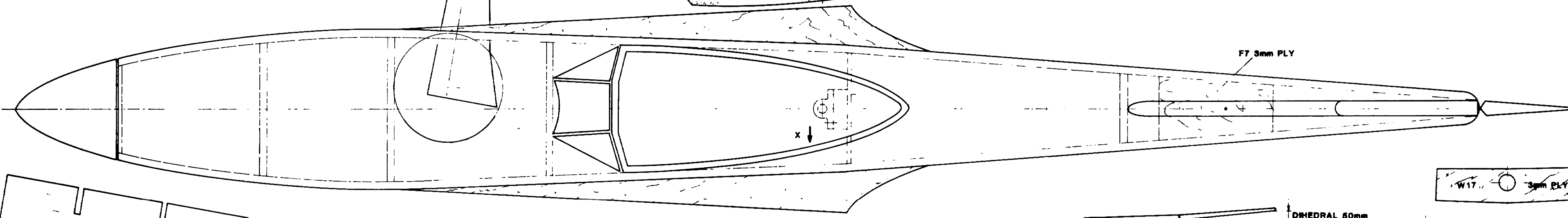

W17 3mm PLY

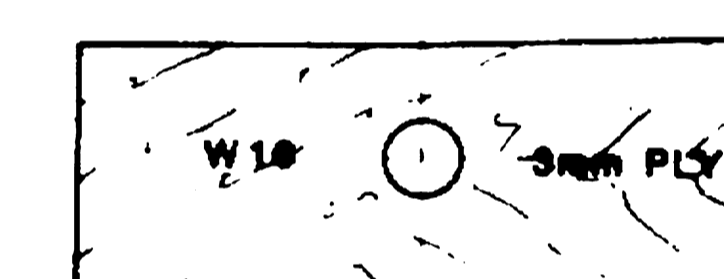

W18 3mm PLY

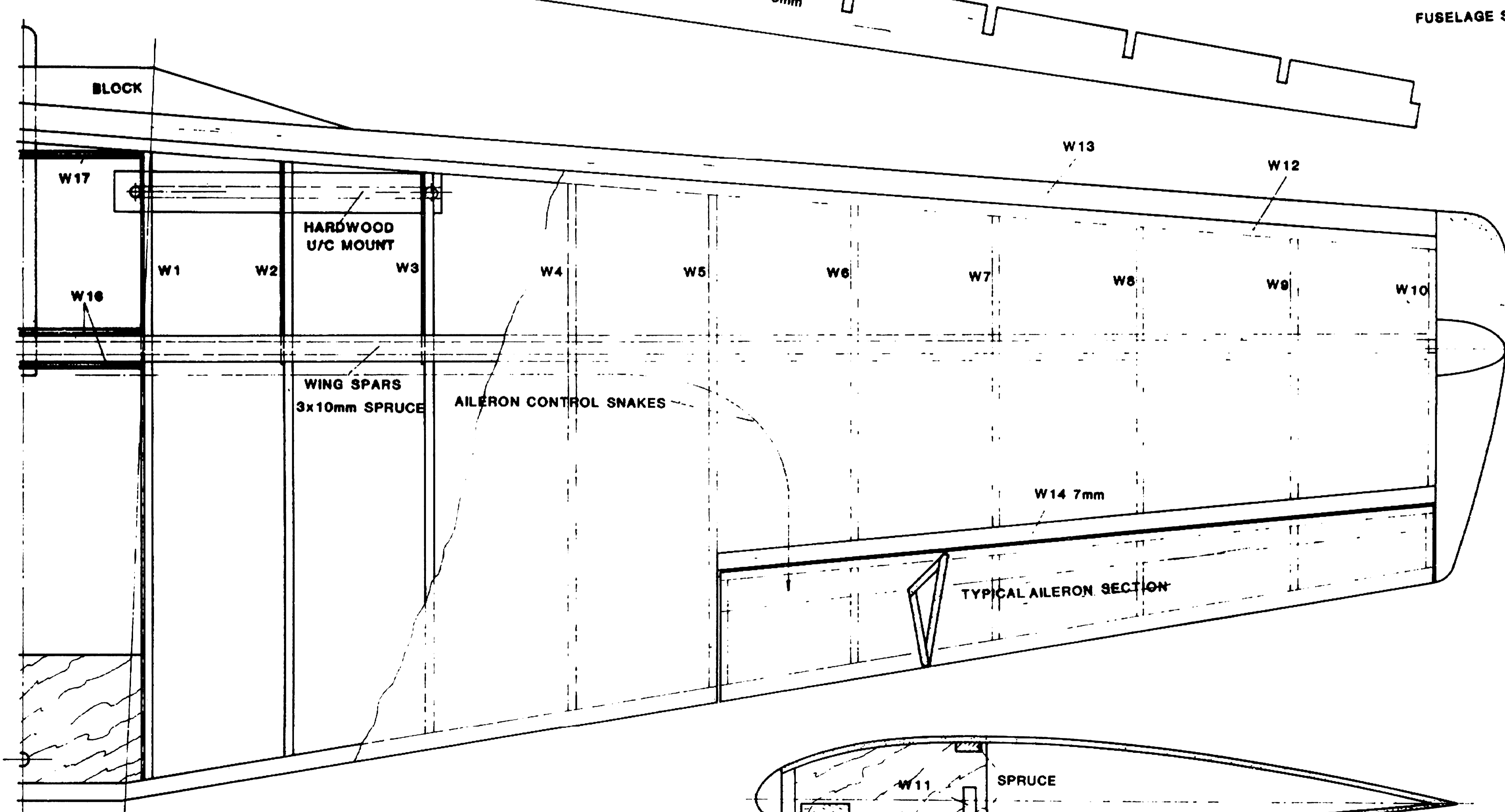

SECTION X X

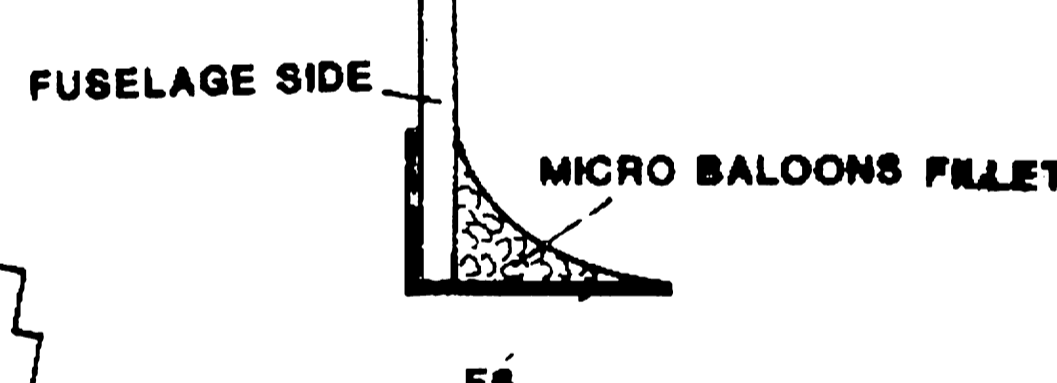

F6

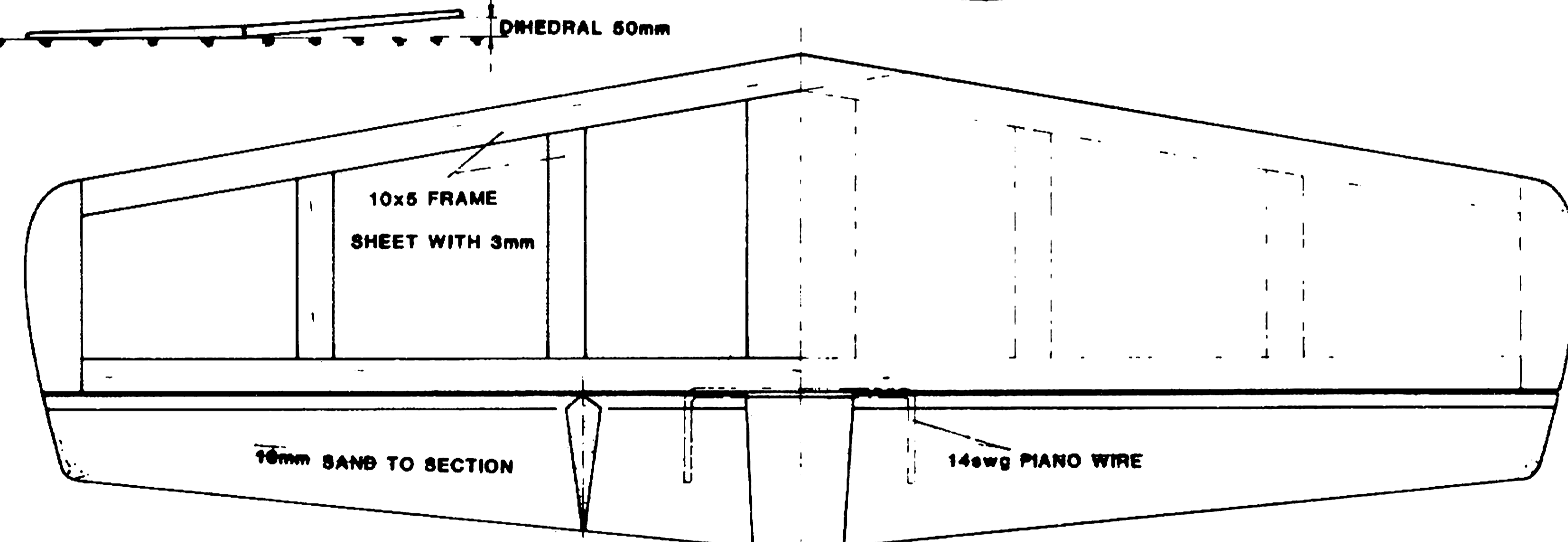

10x5 FRAME
SHEET WITH 3mm

10mm SAND TO SECTION

14wg PIANO WIRE

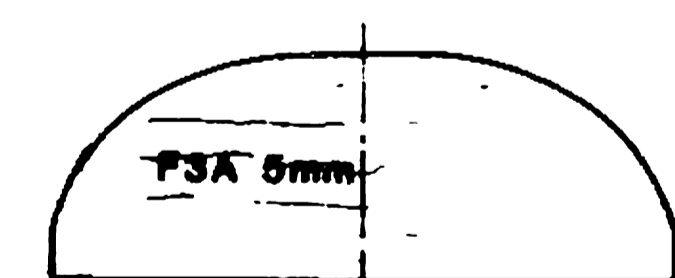

F3A 3mm

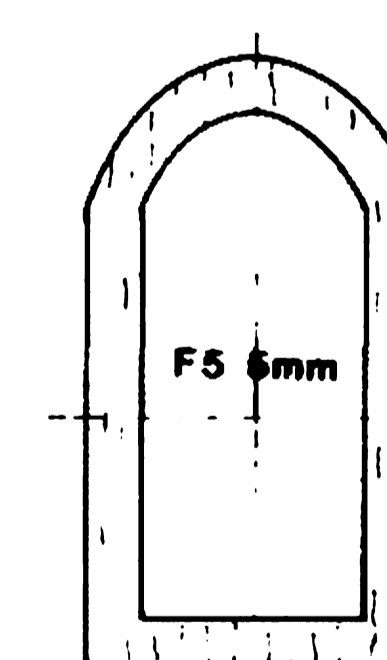

F5 3mm

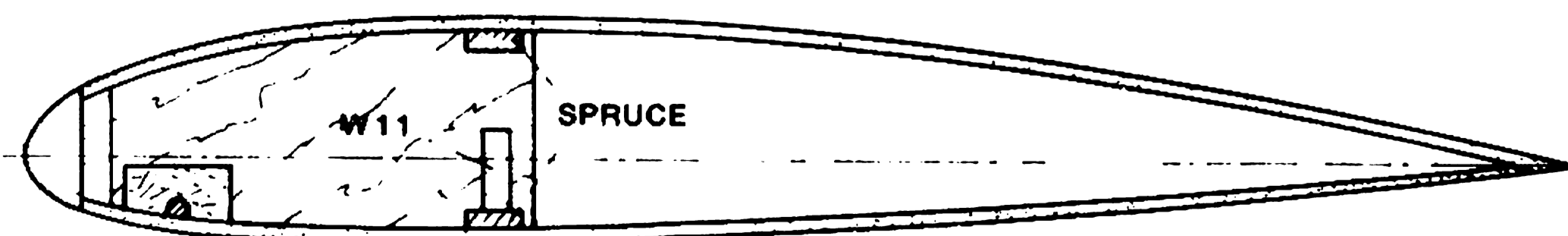

TYPICAL WING SECTION

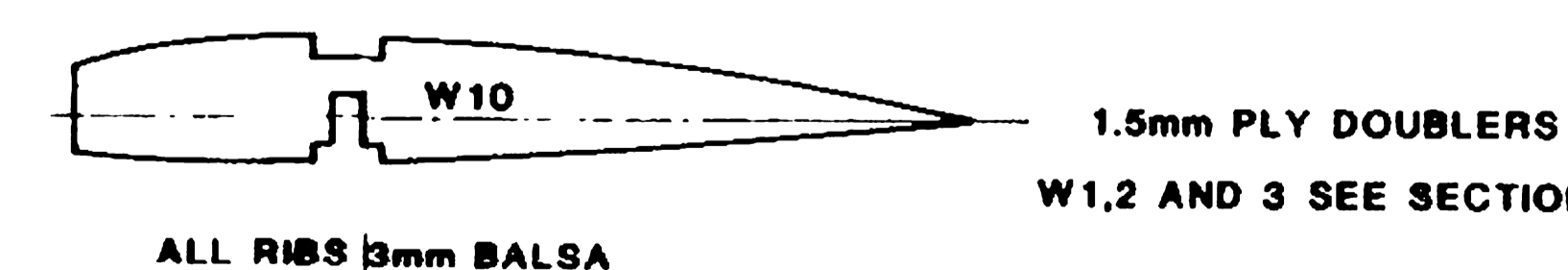

1.5mm PLY DOUBLERS
W1, 2 AND 3 SEE SECTION

ALL RIBS 3mm Balsa

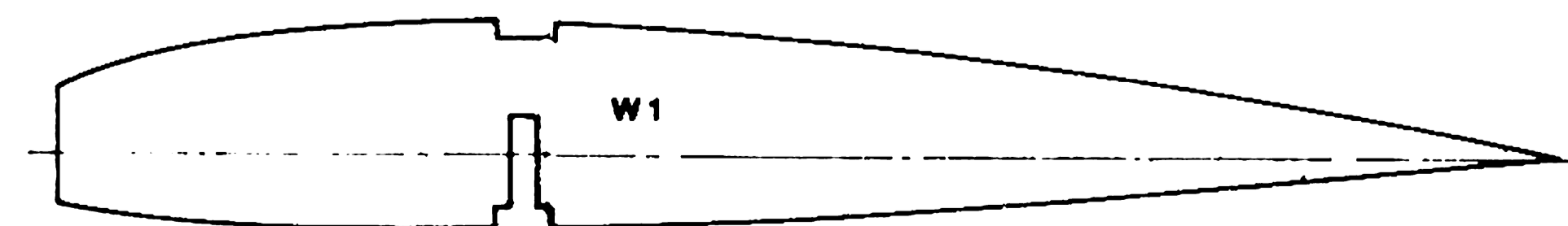

W1

P-51D MUSTANG
designed by
PAVEL BOSAK

The R.C.M.&E. Plans Service