

"TRADITIONAL" SUPER DECATHLON WING TIP SHAPE (NOT INCLUDED)
 PETE MYERS' "CLIPPED" WING TIP SHAPE

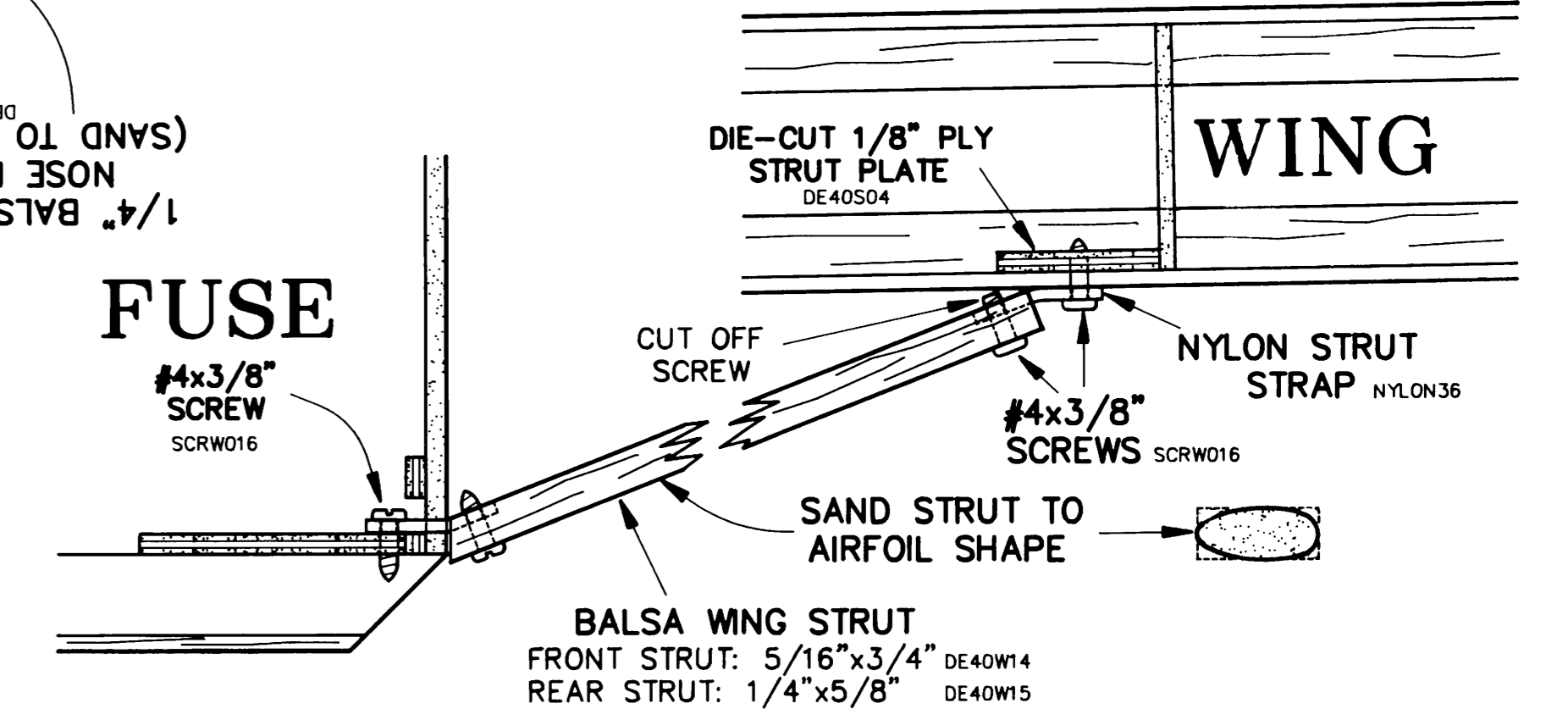

WING TIP CROSS-SECTION

DIHEDRAL DETAIL

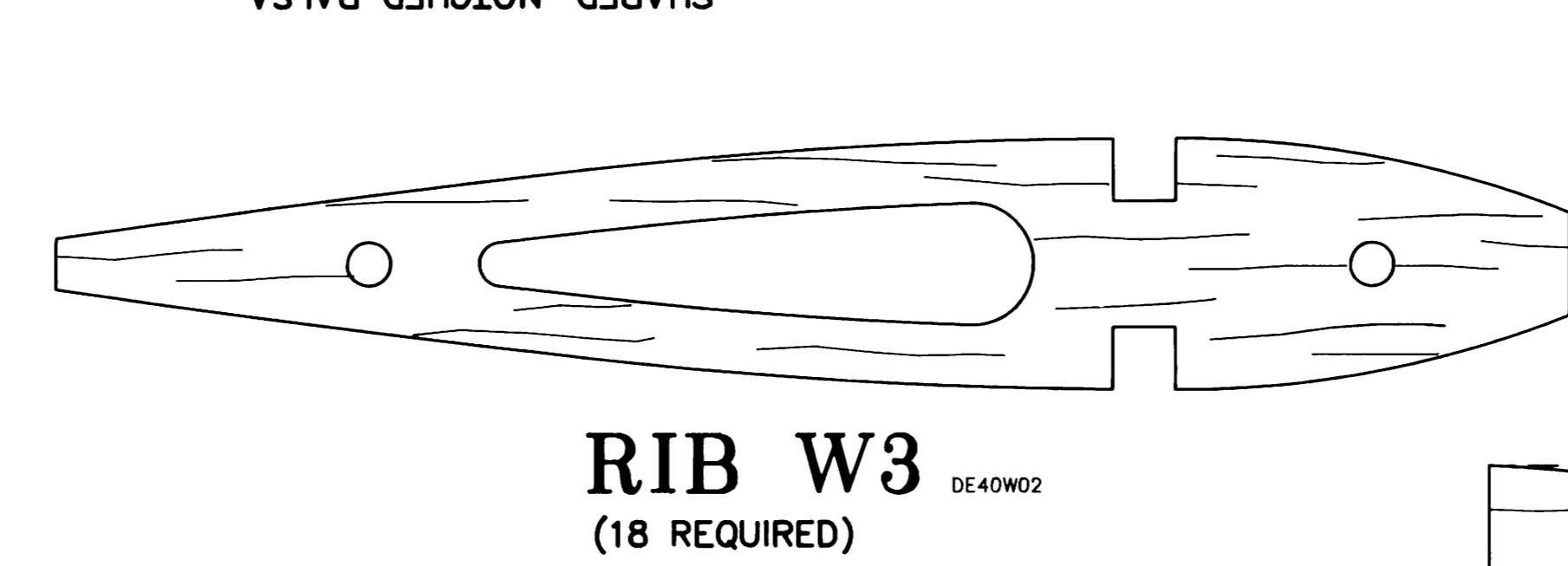
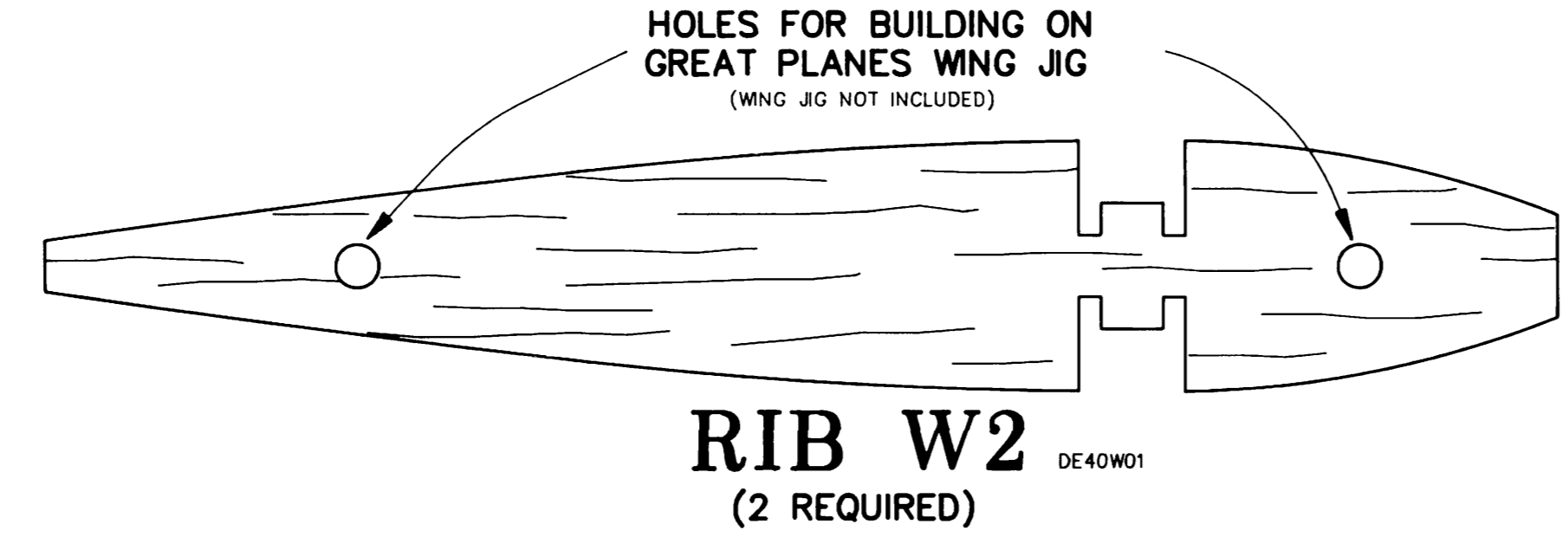
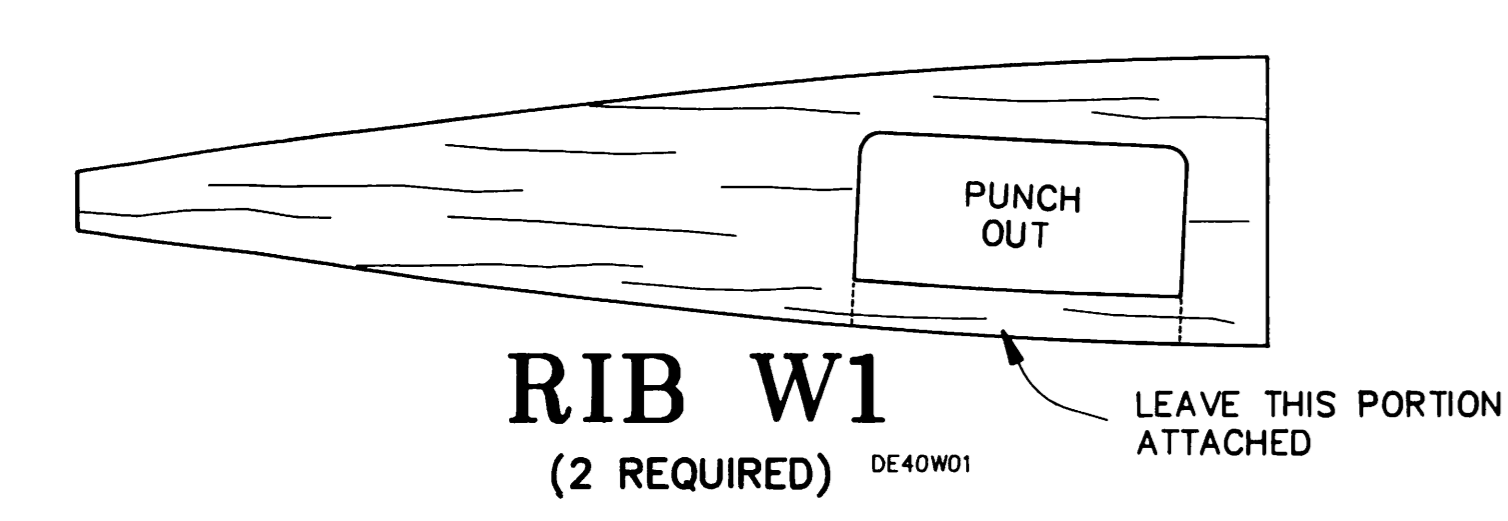
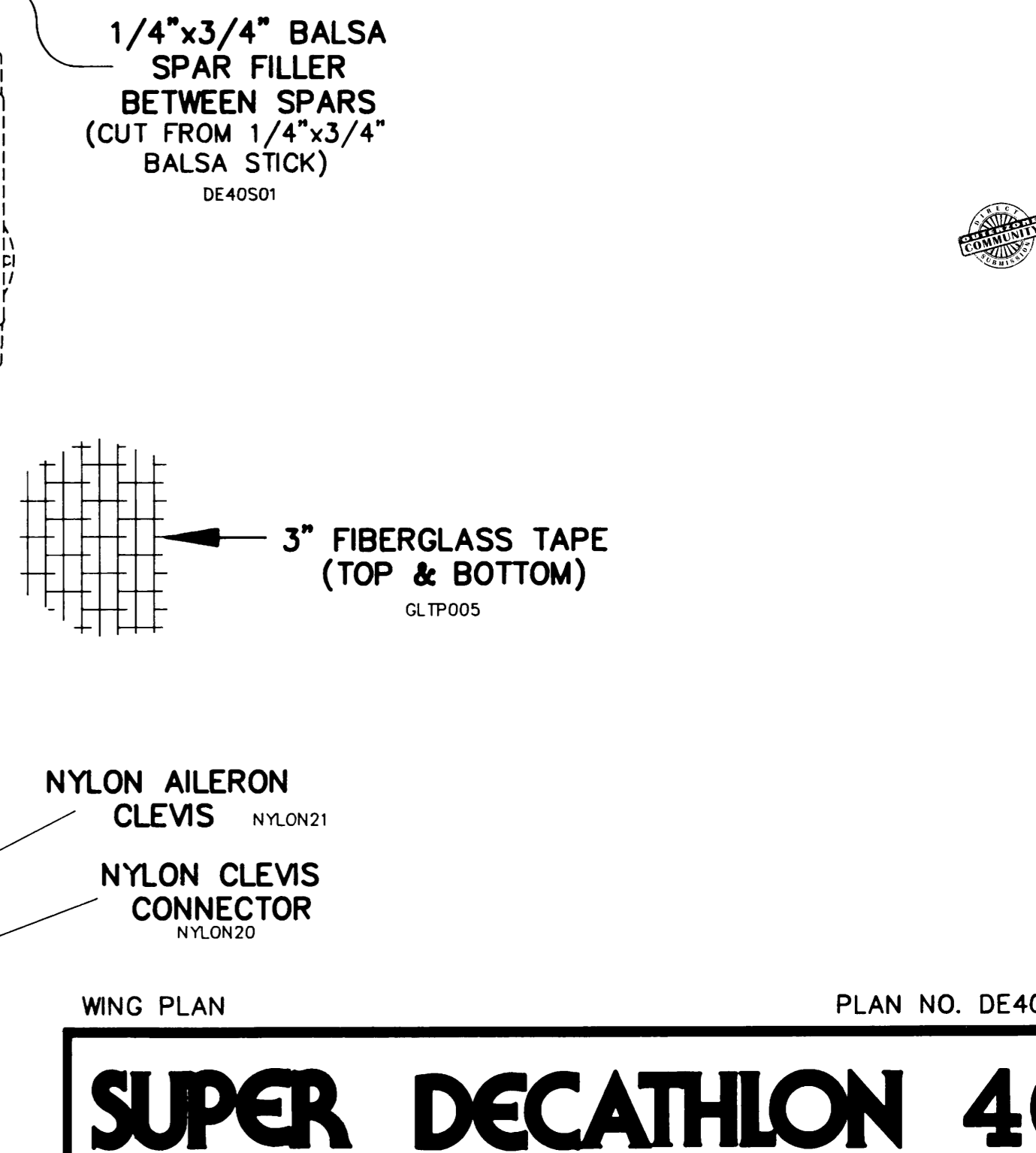
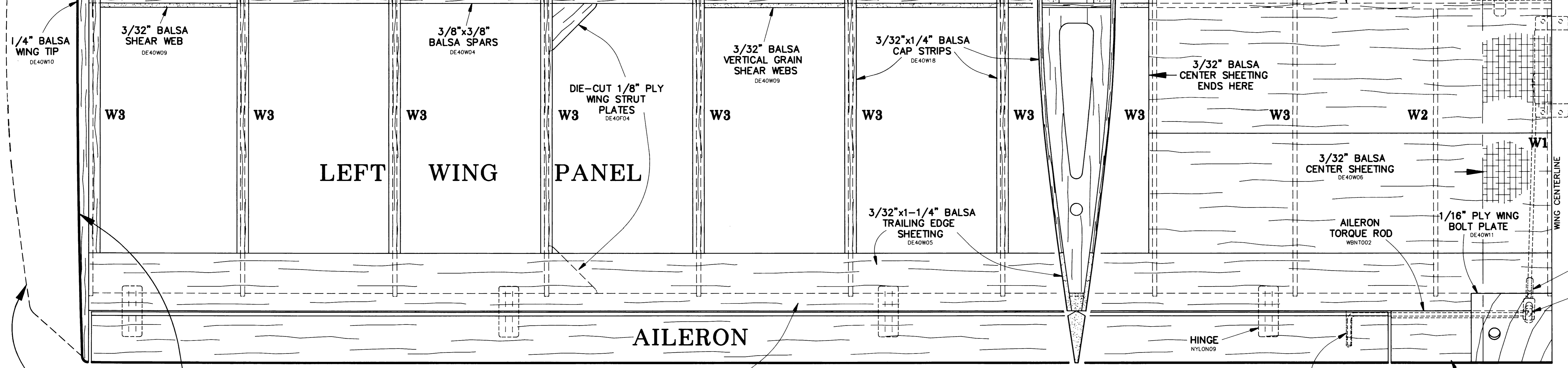
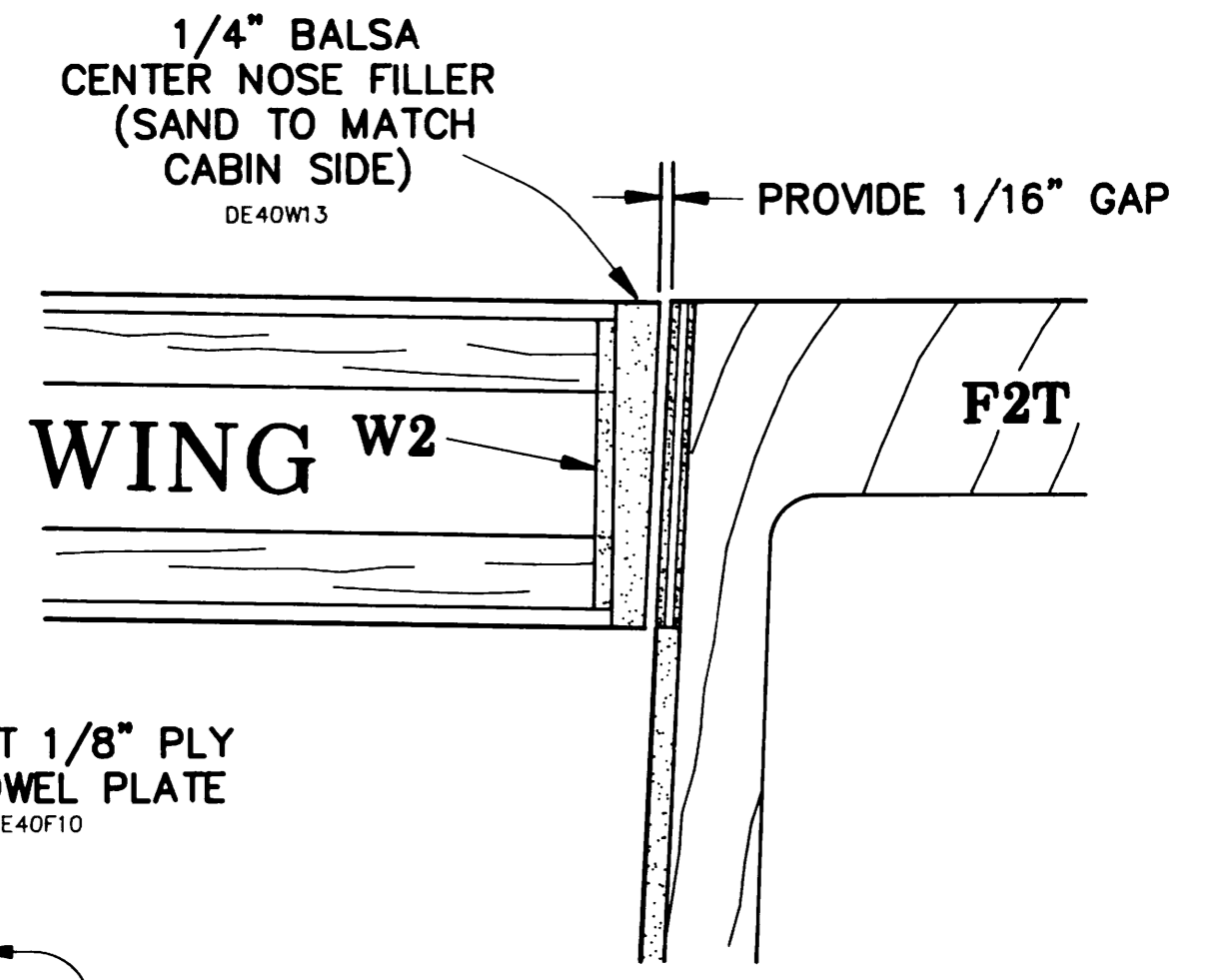
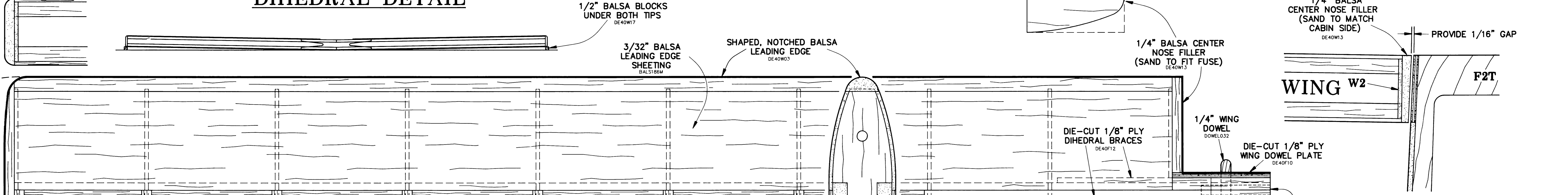

"TRADITIONAL" SUPER DECATHLON WING TIP SHAPE (NOT INCLUDED)
 PETE MYERS' "CLIPPED" WING TIP SHAPE

SHAPED, NOTCHED Balsa TRAILING EDGE DE40W03

EPOXY "SLEEVE" AROUND ROD (SEE INSTRUCTIONS)

TAPERED, GROOVED Balsa CENTER TRAILING EDGE DE40W08

WING PLAN PLAN NO. DE40P02

SUPER DECATHLON 40

DESIGNED BY: DON ANDERSON DRAWN BY: JIM SCHMIDT

GREAT PLANES
 MODEL MANUFACTURING CO., INC.
 P.O. BOX 788 URBANA, IL 61801

ALL COMMERCIAL RIGHTS RESERVED

