

ANTI-VORTEX TIP

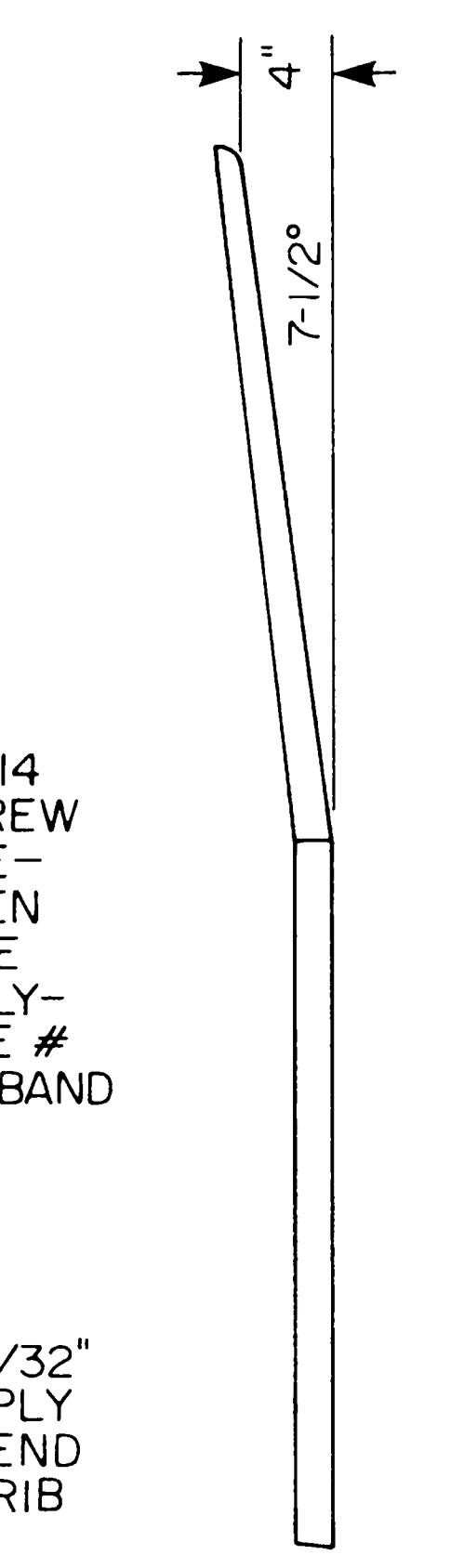

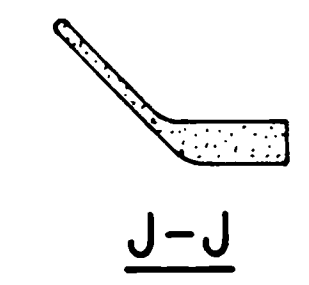
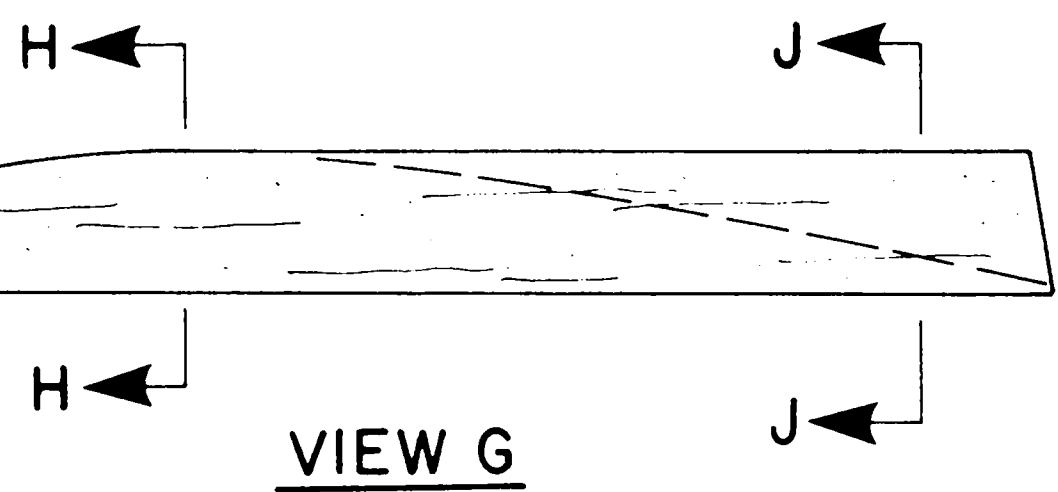
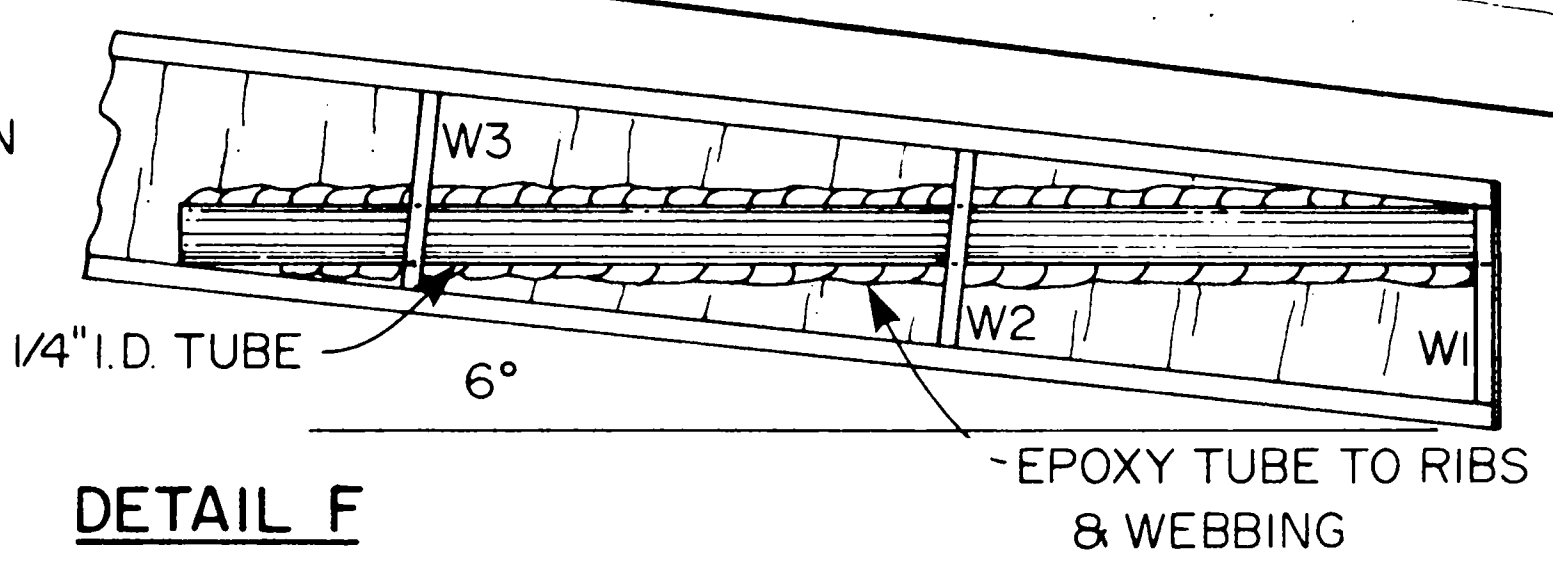
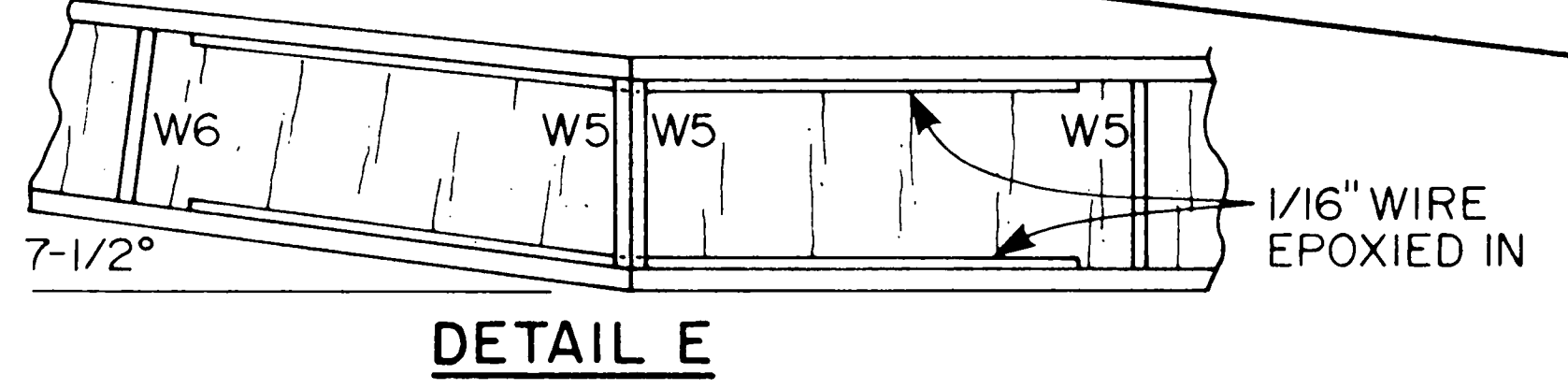
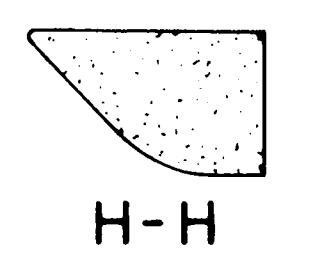

VIKING

DESIGNED BY TOM WILLIAMS DRAWN BY DICK KIDD

0 1 2 3 4 5 6


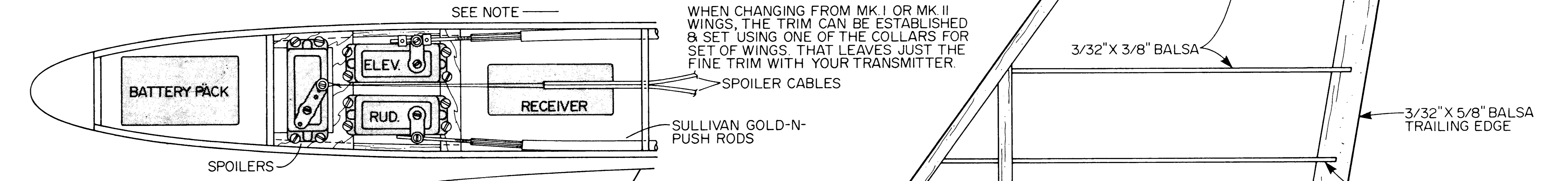
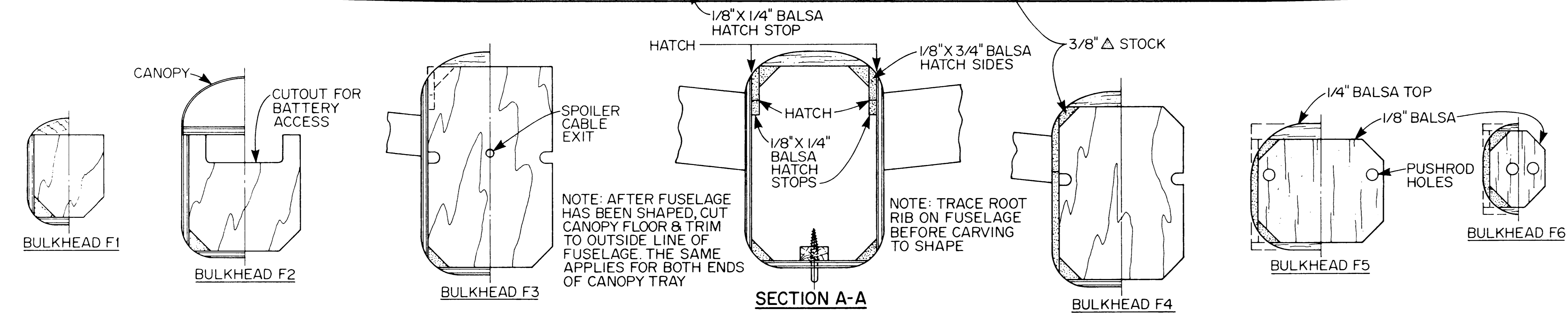


NOTE: BULKHEADS F1 THRU F4 ARE 1/8" POPLAR PLY

DECALAGE (Stab set at 0° on Mk. I & Mk. II)
MARK I (FLAT BOTTOM) WING (Flat bottom line) +1°
MARK II (SEMI-SYMMETRICAL) WING (Mean camber) +3°

VIKING
DESIGNED BY TOM WILLIAMS
DRAWN BY DICK KIDD
0 1 2 3 4 5 6

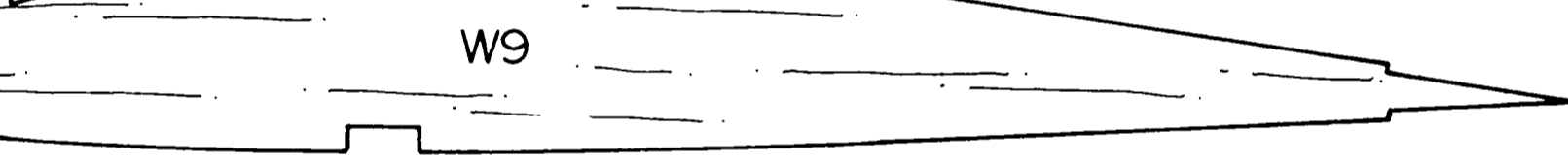
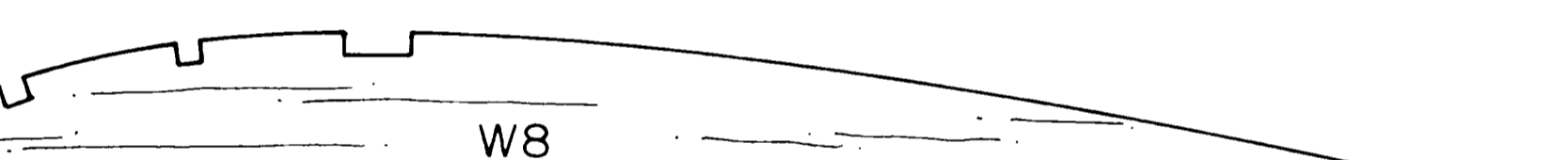
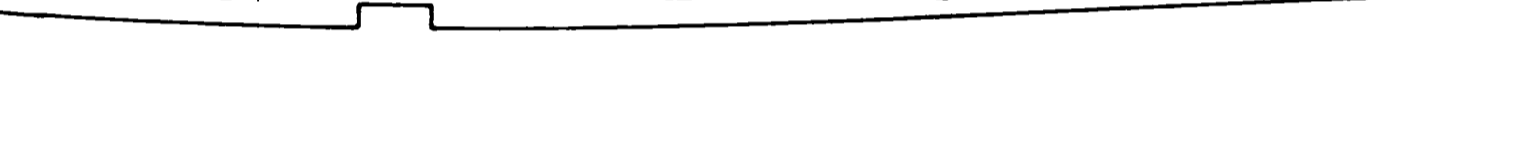
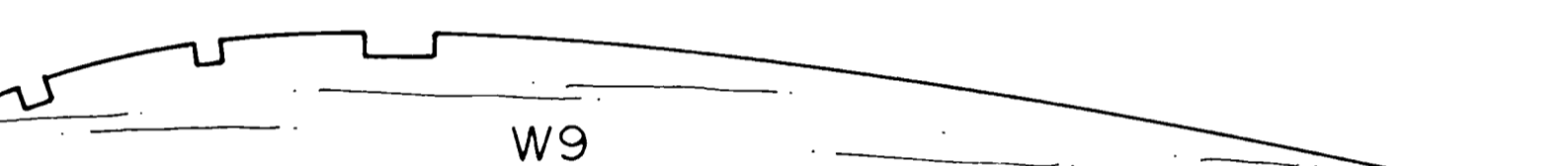
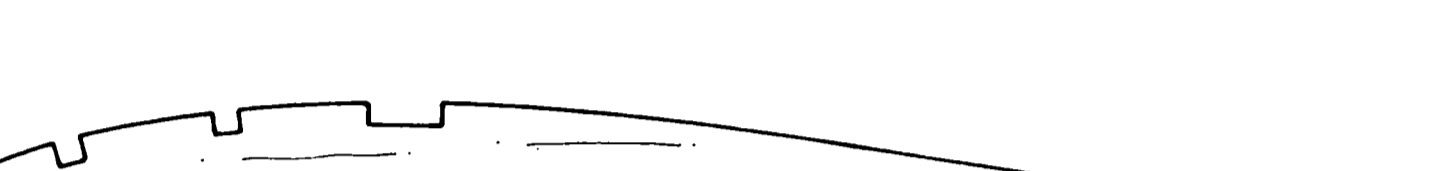
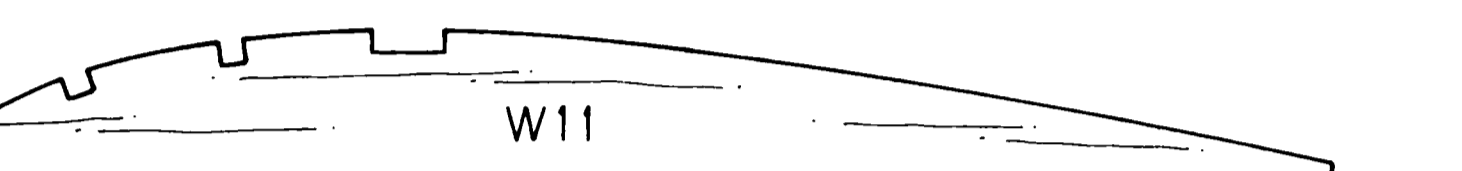
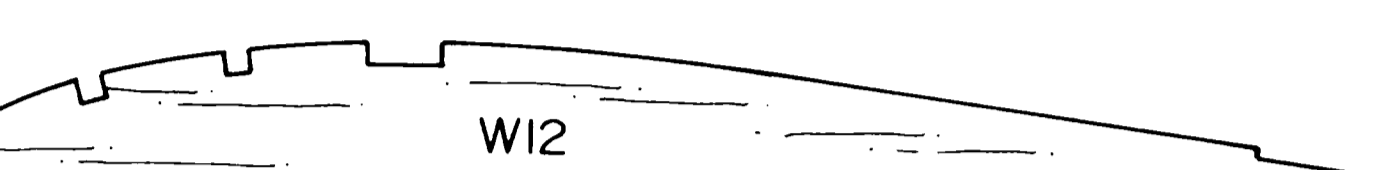
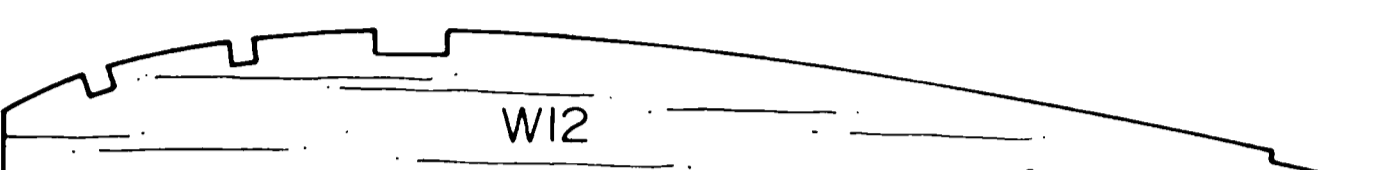
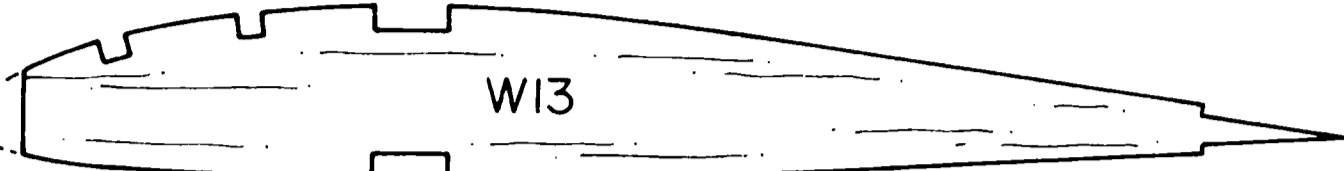
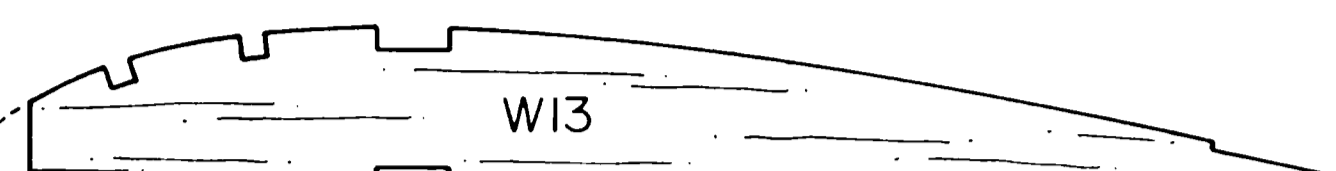
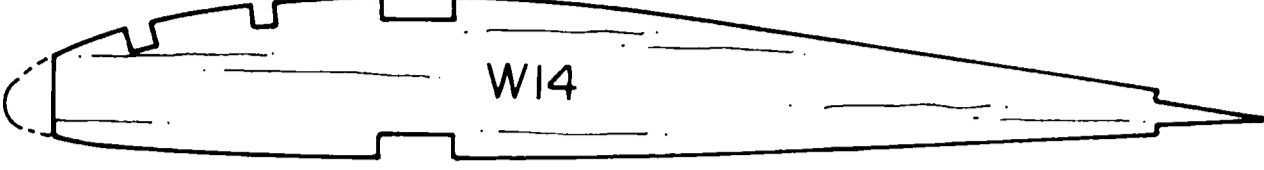
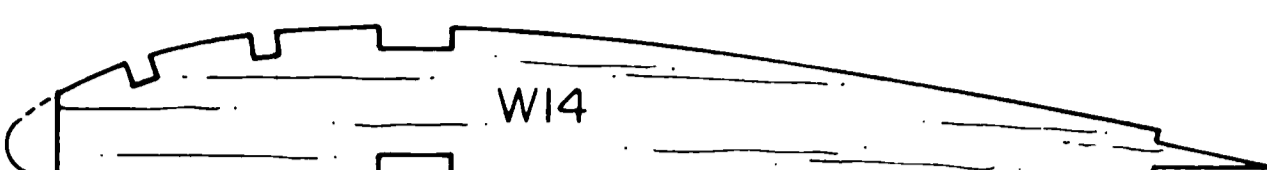
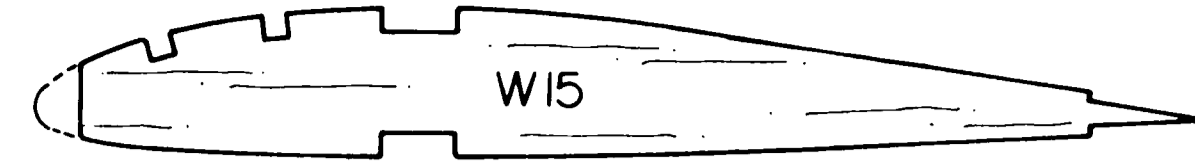
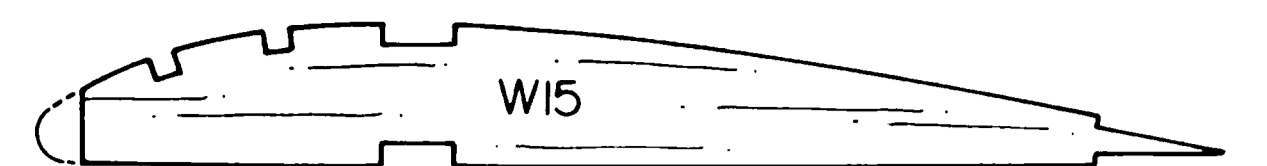

MARK I RIB TEMPLATES

MARK II RIB TEMPLATES

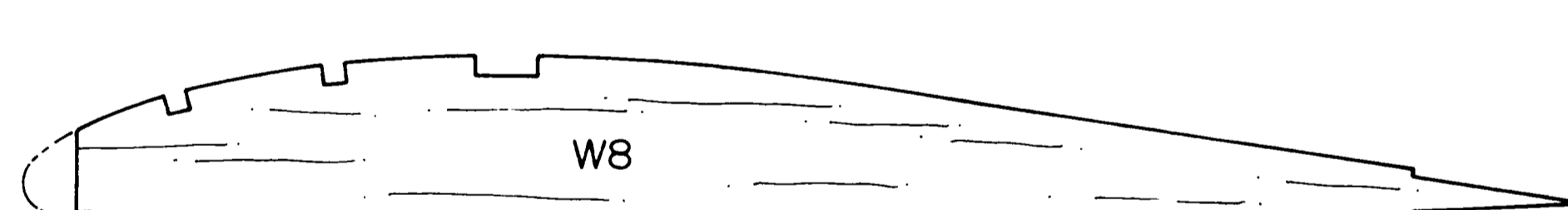
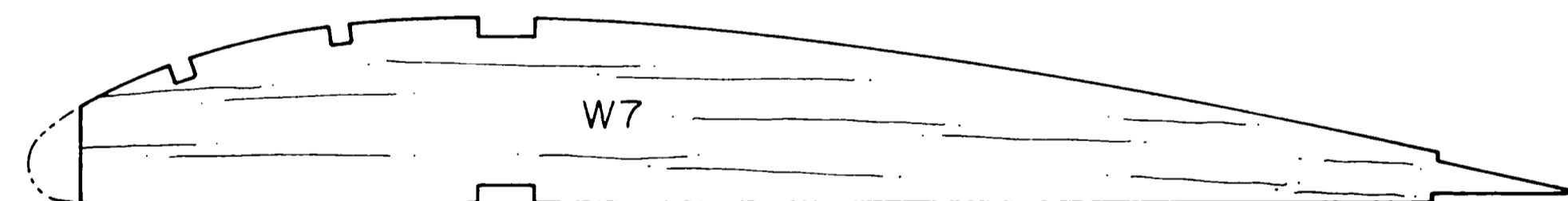

RIBS W5 THRU W15 - 2 EACH REQ'D

RIBS W6 THRU W15 - 2 EACH REQ'D

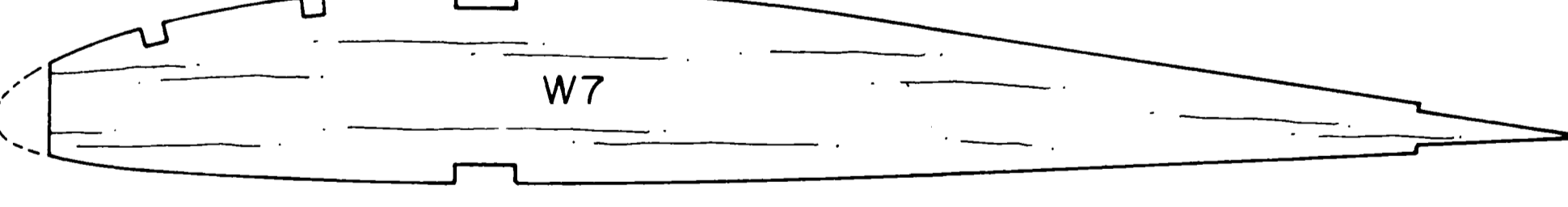
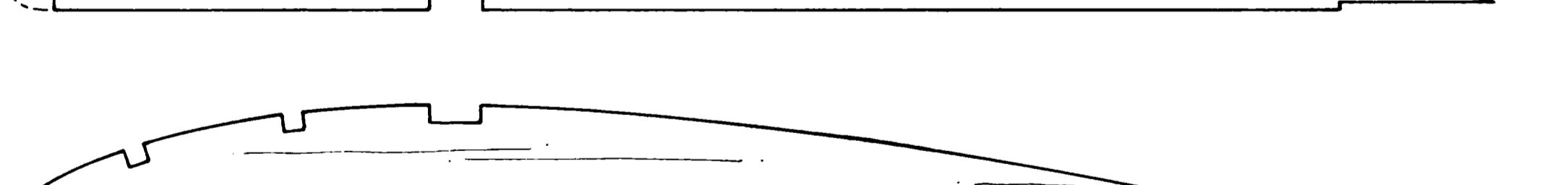
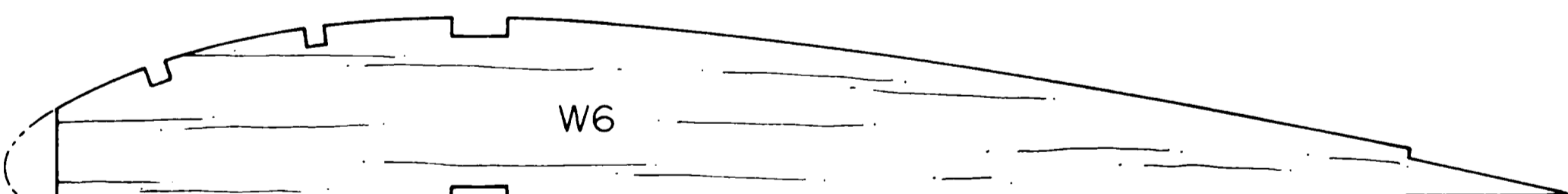

CUTOUT FOR SPOILERS - 4 RIBS EACH PANEL

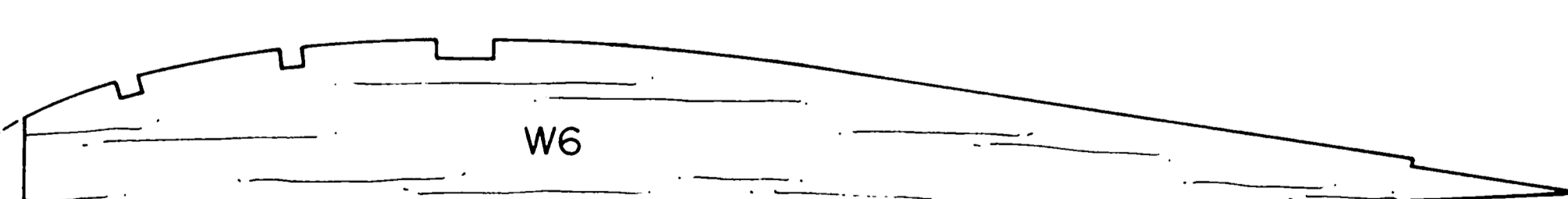
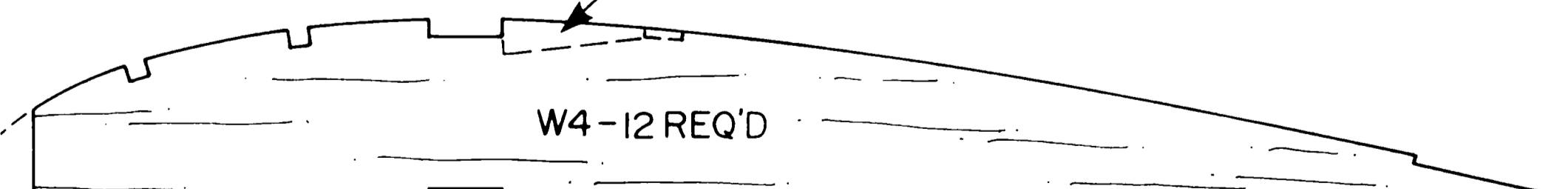

W4 - 12 REQ'D

W4 - 4 REQ'D
W5 - 14 REQ'D

W5 DOES NOT HAVE REAR SPAR NOTCH (TOP & BOT.)

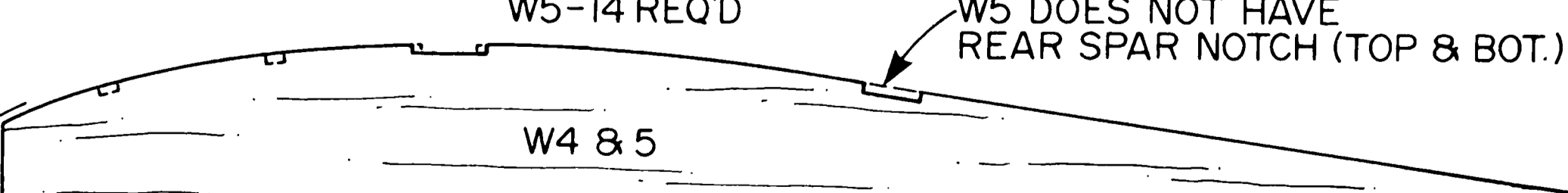
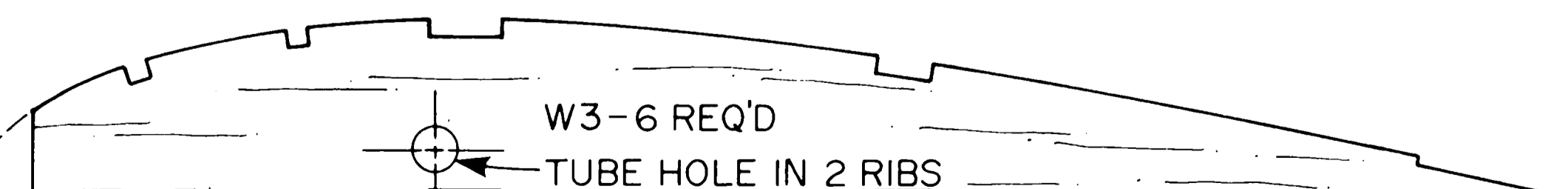

W3 - 6 REQ'D

TUBE HOLE IN 2 RIBS

CUT (2) W5 RIBS WITH 3/8" SPAR NOTCH ALSO 2 NOTCHES FOR TURBULATOR SPARS

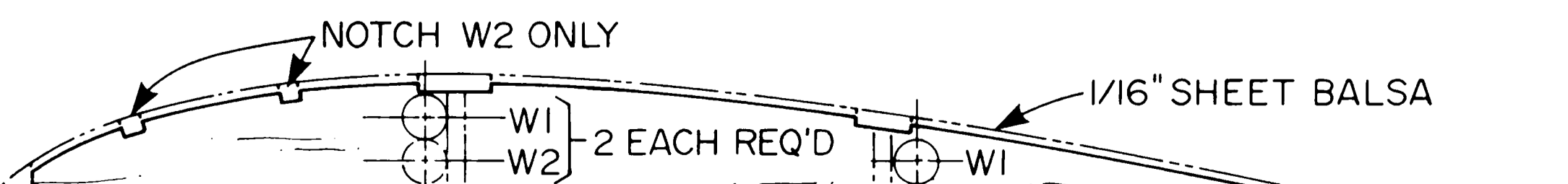

W2 - 2 EACH REQ'D

W1 - 2 EACH REQ'D

W2

W1

W2

W1

W2

W1

W2

W1

W2

W1

W2

W1

W2

W1

W2

W1

W2

W1

W2

W1

W2

W1

W2

W1

W2

W1

W2

W1

W2

W1

W2

W1

W2

W1

W2

W1

W2

W1

W2

W1

W2

W1

W2

W1

W2

W1

W2

W1

W2

W1

W2

W1

W2

W1

W2

W1

W2

W1

W2

W1

W2

W1

W2

W1

W2

W1

W2

W1

W2

W1

W2

W1

W2

W1

W2

W1

W2

W1

W2

W1

W2

W1

W2

W1

W2

W1

W2

W1

W2

W1

W2

W1

W2

W1

W2

W1

W2

W1

W2

W1

W2

W1

W2

W1

W2

W1

W2

W1

W2

W1

W2

W1

W2

W1

W2

W1

W2

W1

W2

W1

W2

W1

W2

W1

W2

W1

W2

W1

W2

W1

W2

W1

W2

W1

W2

W1

W2

W1

W2

W1

W2

W1

W2

W1

W2

W1

W2

W1

W2

W1

W2

W1

W2

W1

W2

W1

W2

W1

W2

W1

W2

W1

W2

W1

W2

W1

W2

W1

W2

W1

W2

W1

W2

W1

W2

W1

W2

W1

W2

W1

W2

W1

W2

W1

W2

W1

W2

W1

W2

W1

W2

W1

W2

W1

W2

W1

W2

W1

W2

W1

W2

W1

W2

W1

W2

W1

W2

W1

W2

W1

W2

W1

W2

W1

W2

W1

W2

W1

W2

W1

W2

W1

W2

W1

W2

W1

W2

W1

W2

W1

W2

W1

W2

W1

W2

W1

W2

W1

W2

W1

W2

W1

W2

W1

W2

W1

W2

W1

W2

W1

W2

W1

W2

W1

W2

W1

W2

W1

W2

W1

W2

W1

W2

W1

W2

W1

W2

W1

W2

W1

W2

W1

W2

W1

W2

W1

W2

W1

W2

W1

W2