

SPITFIRE Mk IX



WARRANTY.....

Top Flite Models guarantees this kit to be free of defects in both material and workmanship at the date of purchase. This warranty does not cover any component parts damaged by use or modification. In no case shall Top Flite's liability exceed the original cost of the purchased kit. Further, Top Flite reserves the right to change or modify this warranty without notice.

In that Top Flite has no control over the final assembly or material used for final assembly, no liability shall be assumed nor accepted for any damage resulting from the use by the user of the final user-assembled product. By the act of using the user-assembled product the user accepts all resulting liability.

If the buyer is not prepared to accept the liability associated with the use of this product, the buyer is advised to immediately return this kit in new and unused condition to the place of purchase.



**Top Flite Models
P.O. Box 788
Urbana, IL 61803**

Technical Assistance - Call (217)398-8970

READ THROUGH THIS INSTRUCTION BOOK FIRST. IT CONTAINS IMPORTANT INSTRUCTIONS AND WARNINGS CONCERNING THE ASSEMBLY AND USE OF THIS MODEL.

TABLE OF CONTENTS AND BUILDING SEQUENCE

INTRODUCTION	3
PRECAUTIONS	3
DECISIONS YOU MUST MAKE	3
Engine selection	3
Exhaust system	4
Retractable landing gear.....	4
Flaps.....	4
TOP FLITE SCALE ACCESSORIES	4
Scale cockpit interior.....	4
Scale propeller and spinner	5
COMPETITION-MINDED MODELERS	5
OTHER ITEMS REQUIRED	5
Building supplies	6
Tools	6
IMPORTANT BUILDING NOTES	6
COMMON ABBREVIATIONS	7
TYPES OF WOOD	7
GET READY TO BUILD	7
DIE-CUT PATTERNS	8&9
BUILD THE TAIL SURFACES	10
Build the stab	10
Build the elevators	12
Build the fin	14
Build the rudder	15
BUILD THE WING	16
Preparations	16
Build the outer wing panels.....	17
Build the center section	19
Join the outer panels to the center section	21
Fit the landing gear	22
Prepare the outer panels for sheeting	23
Make the wing skins	23
Sheet the bottom of the wing	24
Prepare the top of the wing for sheeting.....	25
Sheet the top of the wing	27
Build the flaps	27
Build the ailerons	30
Finish the wing.....	31
BUILD THE FUSELAGE	32
Frame the fuselage top.....	32
Sheet the top of the fuselage.....	35

Mount the fin and stab	36
Finish framing the fuselage.....	37
Mount the tail wheel assembly.....	38
Prepare the fuse for sheeting	39
Sheet the bottom of the fuse.....	40
FINAL CONSTRUCTION	41
Mount the wing to the fuselage.....	41
Build the wing fillet	42
Build the bottom wing fairing.....	43
Mount the engine and cowl.....	43
Hookup the controls	45
Install the radio	47
Install the cockpit and canopy.....	48
FINISHING	49
Fuelproofing	49
Prepare the model for covering	49
Balance the airplane laterally.....	49
Cover the model with MonoKote.....	50
Painting.....	51
Join the control surfaces.....	52
Scale details	52
GET YOUR MODEL READY TO FLY	56
Balance your model	56
Final hookups and checks	57
PREFLIGHT	58
Identify your model	58
Charge your batteries	58
Balance your propellers	58
Find a safe place to fly.....	58
Ground check your model.....	58
Range check your radio.....	58
Check list	58
ENGINE SAFETY PRECAUTIONS	59
AMA SAFETY CODE	60
FLYING	60
Takeoff.....	60
Flight	60
Landing	61
Flaps	61
TWO VIEW DRAWING	back cover

PROTECT YOUR MODEL, YOURSELF & OTHERS FOLLOW THIS IMPORTANT SAFETY PRECAUTION

Your Spitfire is not a toy, but a sophisticated working model that functions very much like an actual airplane.

Because of its realistic performance, if you do not assemble and operate your Spitfire correctly, you could possibly injure yourself or spectators and damage property.

To make your R/C modeling experience totally enjoyable, get assistance with assembly and your first flights from an experienced, knowledgeable modeler. You'll learn faster and avoid risking your model before you're truly ready to solo. Your local hobby shop has information about flying clubs in your area whose membership includes qualified instructors.

You can also contact the Academy of Model Aeronautics (AMA), which has more than 2,500 chartered clubs across the country. We recommend you join the AMA which will insure you at AMA club sites and events. AMA membership is required at chartered club fields where qualified flight instructors are available.

Contact the AMA at the address or toll-free phone number below:

Academy of Model Aeronautics
5151 East Memorial Drive
Muncie, IN 47302-9252
Tele. (800) 435-9262
Fax (765) 741-0057

or via the internet at : <http://www.modelaircraft.org>

Your Top Flite Gold Edition Spitfire Mk IX is intended for scale and general sport flying including mild aerobatics such as loops, stall turns, rolls, etc. Its structure is designed to withstand such stresses. If you intend to use your Spitfire for more abusive types of flying such as racing, aggressive aerobatics, or flying from rough fields, it is your responsibility to reinforce areas of the model that will be subjected to the resulting unusually high stresses.

INTRODUCTION

Congratulations and thank you for purchasing the **Top Flite Gold Edition Spitfire**. The model we have chosen to replicate is the Mk IX—the second most popular *Spit* ever, reaching a total production of 5,665 units. Considered to be the finest Spitfire of all, the Mk IX went into operational service in July, 1942.

Though all of the models in the Gold Edition line feature standard construction techniques and basic materials that most modelers are familiar with, we feel that the Spitfire may be the easiest one to build. Although the Spitfire *is* a scale model with plenty of detail, it is one of the cleanest subjects without any tricky areas found on some scale birds. If you're not already in love with the Spitfire, you're in for a surprise! The *Spit* doesn't seem to have the menacing looks of the husky P-47 or the speedy P-51, but as you near completion you'll grow to appreciate the clean lines and round contour of your Spitfire. And after the covering is done, you've added all the scale details and put the wing on the fuse, you'll be transformed into a true Spitfire fan! With the British roundels and invasion stripes, your Spitfire will surely stand out from the rest of the models on the flight line!

Another phenomenon with the Spitfire is its deceiving size while under construction. At first, you may think " *Gee, these tail surfaces sure are small*" or, "*This*

model doesn't have a very big wingspan." But don't worry. Once you join the tail surfaces to the fuse, add the cowl and spinner, then glue the wing tips to the wing and put it all together, your enthusiasm will soar when you realize that this really is a good size model!

One last note before you get started: we highly recommend you get some pictures or a book about Spitfires, or send for your documentation package as soon as possible. This way, you can study the drawings and photos to get a feel for how your Spitfire should look when you're done. This will also help you figure out what scale details to add and decide on a trim scheme (you can also dream about how cool **your** Spitfire is going to look.) One of the books we recommend is the Squadron/Signal Publications *Spitfire in Action* book No. 39 (SQUZ1039). It features lots of historical and technical information as well as detailed drawings, photos and trim schemes.

Well, this should be enough to get your juices flowing, so move your other projects off your workbench, say goodbye to your significant other for a while and read on!

NOTE: We, as the kit manufacturer, provide you with a top quality kit and great instructions, but ultimately the quality and flyability of your finished model depends on how you build it; therefore, we cannot in any way guarantee the performance of your completed model, and no representations are expressed or implied as to the performance or safety of your completed model.

Please inspect all parts carefully before starting to build! If any parts are missing, broken or defective, or if you have any questions about building or flying this model, please call us at (217) 398-8970 and we'll be glad to help. If you are calling for replacement parts, please look up the part numbers and the kit identification number (stamped on the end of the carton) and have them ready when calling.

PRECAUTIONS

1. You must build the plane **according to the plan and instructions**. Do not alter or modify the model, as doing so may result in an unsafe or unflyable model. **In a few cases the plan and instructions may differ slightly from the photos. In those instances you should assume the plan and written instructions are correct.**
2. You **must** take time to **build straight, true and strong**.
3. You must use a proper R/C **radio** that is in first class condition, the correct sized **engine** and correct **components** (fuel tank, wheels, etc.) throughout your building process.
4. You must properly **install** all R/C and other components so that the model operates properly on the ground and in the air.
5. You must **test** the operation of the model before every flight to insure that all equipment is operating and you must make certain that the model has remained structurally sound.
6. If you are not already an experienced R/C pilot, you must **fly** the model **only with the help** of a competent, experienced R/C pilot.

DECISIONS YOU MUST MAKE

ENGINE SELECTION

Recommended engine size:

.61 to .75 cu. in. [10.0 - 12.0cc] **2-stroke**

.70 to .91 cu. in. [11.5 - 15.0cc] **4-stroke**

Your Spitfire will fly **well** with any of the recommended engines. The 4-stroke engines and most .75 cu. in. [12.0cc] 2-stroke engines will turn a

larger prop at lower RPM. This is often desirable for scale realism. Many .61 cu. in. [10.0cc] 2-stroke engines produce about as much horsepower as the popular .75 [12.0cc] 2-stroke engines and will fly the Spitfire extremely well. If you use a .61 [10.0cc] 2-stroke, a ball bearing, Schnuerle-ported engine is recommended. Our prototype *Spit* weighs 9-1/2 pounds [4310g] with all of the options, including flaps and the scale cockpit interior and was flown with an O.S. .61 cu. in. [10.0cc] engine. **This engine provided excellent performance and more than enough power.** Although larger engines can be used to power this model, the extra horsepower is **not** needed.

The included adjustable engine mount will hold a range of engines from .61 cu. in. [10.0cc] 2-stroke through .91 cu. in. [15.0cc] 4-stroke.

EXHAUST SYSTEM

A Top Flite® header and muffler are available that will fit inside your cowl. They are designed for 2-stroke engines mounted inverted as used on the model and shown in the instructions. We also used a 3/4" [19mm] (inside diameter) Silicone tube (AERG2220) to connect the muffler to the header.

Headers:

for O.S.® .61SF, TOPQ7920

for SuperTigre™ .61-.75 K series (muffler bolts go through the **muffler** and screw into the **engine**), TOPQ7925

for SuperTigre .61-.75 G series (muffler bolts go through the **engine** and screw into the **muffler**), TOPQ7926

.61-.75 Warbird In-Cowl Muffler, TOPQ7915

RETRACTABLE LANDING GEAR

You may build your Spitfire either with fixed or retractable landing gear. Of course, fixed landing gear will be easier to install than retracts; but we provide detailed instructions on retract installation so you should have no trouble. Your Gold Edition Spitfire is designed to accept the Robart #605 90 degree HD (*Heavy Duty* with 3/16" [4.8mm] struts) pneumatic retracts. You may use other retractable landing gear systems but it is up to you to make any modifications that may be necessary. With the Robart retracts, you may substitute scale appearing oleo-type *Robostruts* for the coil-and-wire landing gear wires included with the retracts. However, we recommend Robostruts only for experienced fliers as they are very rigid and do not absorb as much shock as standard wire-and-coil landing gear. We mounted a micro servo in the bottom servo tray to actuate the air control valve. You could use a standard servo for this but you may have to mount it in an alternate location.

For Retractable Landing Gear you will need these items:

Robart #605 90 degree HD Pneumatic Retracts (ROBQ0005)
Great Planes® 2" x 3/16" [50 x 4.8mm] Bolt-On Axles (GPMQ4278)
Great Planes 3/16" [4.8mm] wheel collars (GPMQ4309)
Robart #188 Air Control Kit (ROBQ2388)
Robart #164G Hand Pump with Gauge (ROBQ2363)
(2) Robart #190 Quick Connectors (ROBQ2395 pkg. of 2)
Robart #189 Air Restrictor (ROBQ2395)
Servo for the air control valve (micro or mini servo preferred)

FLAPS

Your Spitfire is designed to incorporate scale split flaps; however, **flaps are optional and not necessary** for an excellent flying experience. Without flaps, the takeoff roll is longer and the landing speed is faster.

The flaps are not difficult to build, but they do require good craftsmanship to fit well. Flaps add nicely to the model's flight characteristics and scale appearance. Only slight trim correction is needed when flaps are used with the recommended throws. Flaps are highly recommended for those who wish to install them. You will find more information on the use of the flaps in the *Flying* section near the end of this manual.

For Flaps, you will need the following additional items:

Standard servo
6" [150mm] Servo extension
(8) Small Pivot Point Hinges
(GPMQ4001, pkg. of 15)

TOP FLITE SCALE ACCESSORIES

SCALE COCKPIT INTERIOR



Your Spitfire won't be complete without the Top Flite Spitfire Scale Cockpit Kit (TOPQ8403). The cockpit kit includes the floor, side panels,

instrument panel, seat and armor back rest! You don't install the cockpit kit until you are near the end of construction and no modifications to the fuselage are required to install it. Instructions for painting, detailing and installing your Scale Cockpit Kit are included with the cockpit kit.

SCALE PROPELLER AND SPINNER

Although Top Flite does not offer a scale static display propeller for your Spitfire, you can modify the Top Flite scale P-51 propeller (TOPQ7906) to look like the Spitfire propeller. This requires a little bit of *elbow grease* and is only recommended for modelers who have a belt sander or who are prepared to do lots of sanding by hand to whittle the blades down. An alternate method would be to join two 19" [480mm] wood propellers and carve them to shape. In either case a template is provided on the plan so you can arrive at the correct propeller blade shape for your Spitfire. See page 53 of the manual for more information on the static display propeller.

For the spinner, we used a Top Flite 3.5" [89mm] white spinner (TOPQ5406). We primed and then painted it. It's nearly the same shape as the Spitfire Mk IX spinner. This is the same spinner we recommend for flying so you might want to buy two spinners—one for your static display prop and one for flying.

COMPETITION-MINDED MODELERS

We designed our Spitfire from scale drawings supplied by Scale Model Research (address follows) and drawings and sketches in Squadron's *Spitfire in Action* book. The scale of your Gold Edition Spitfire Mk IX is 1:7, or one-seventh scale.

If you plan to enter your *Spit* in scale competition (it's lots of fun and the runways are almost always paved!), this kit qualifies for **Fun Scale** and the

Sportsman and *Expert* classes in **Sport Scale**. Fun Scale and Sport Scale have the same flight requirements where you must perform ten maneuvers of which five are mandatory. The other five are up to you—easy stuff like a loop or a roll, a slow, low pass with flaps extended, or maybe a touch-and-go. If you have never competed in a scale contest, you could start out in Fun Scale. In Fun Scale, the only documentation you need for static judging is any proof that a full size aircraft of this type, in the paint/markings scheme on your model, did exist. A single photo, a kit box cover, even a painting is sufficient proof! If you're interested, contact the AMA for a rule book which will tell you everything you need to know. Look in the back of the AMA magazine (*Model Aviation*) for a schedule of events.

The main landing gear has been moved outward. They pivot in a scale manner as the full sized Spitfires did, but the wells are moved slightly out and forward, just behind the main spar. The stance on the ground is scale. This modification greatly improves the ground handling of the model.

Although the fin and stab retain their accurate hinge line, the entire tail (fin/rudder and stab/elevator) have been enlarged by 19.5%. This gives the model a very solid feel in the air and will allow the model to remain controllable through the stall.

The trim scheme of the Spitfire on the kit box cover is the same as the one on the cover of the Squadron book (there are many more trim schemes inside too). Our prototype was covered in grey Top Flite MonoKote® film, then painted olive drab and flat-coated with Top Flite LustreKote™. Decals for the trim scheme on the box are provided in the kit but you could make your own from MonoKote film if you decide to try another trim scheme. You should also look into the *flat* MonoKote film colors. They are ideal for military trim schemes such as the ones found on many Spitfires.

If you are not too concerned with an exact scale trim scheme you can make a variation of the one on the box, or design your own. If you are going to compete in scale competition, use the photos in your documentation package as a guide for your trim scheme.

DOCUMENTATION

Three view drawings and photo packs of full size Spitfires are available from:

Scale Model Research

3114 Yukon Ave, Costa Mesa, CA 92626
(714) 979-8058

OTHER ITEMS REQUIRED

These are additional items you will need to complete your Spitfire that are *not included* with your kit. Order numbers are in parentheses (GPMQ4161). Our exclusive brand is listed where possible: **TOP** is the Top Flite brand, **GPM** is the Great Planes brand and **HCA** is the Hobbico® brand.

- 4 to 6 channel radio with 5 to 7 servos
- (1) Y-connector for aileron servos
- (1) 6" [150mm] servo extension cord for ailerons
- 3-1/2" [89mm] Main Wheels (ROBQ1516)
- (2) 3/16" [4.8mm] Wheel Collars (GPMQ4309)
(4 pcs. for fixed gear)
- 1-1/4" [32mm] Tail wheel (GPMQ4282)

- 3/32" [2.4mm] Wheel Collar for tailwheel (GPMQ4302)
- 12 oz. [360cc] Fuel Tank (GPMQ4105)
- 24" [610mm] Medium Silicone Fuel Tubing (GPMQ4131)
- Fuel Filler Valve (GPMQ4160)
- 3-1/2" [89mm] Spinner, see Scale propeller and spinner section on page 53
- 1/4" [6mm] R/C Foam Rubber Padding (HCAQ1000)
- Pilot Figure (WBRQ2476) (a 1/7-scale pilot figure is optional if the cockpit kit is used)
- Exhaust Deflector (HCAP2175)
- 2 - 3 rolls Top Flite Super MonoKote covering, see page 50
- Paint, see page 51
- Propellers, see the instructions with your engine

BUILDING SUPPLIES

Here is a check list of supplies you should have on hand while building. We recommend Great Planes Pro™ CA and Epoxy.

- 2 oz. [60g] Thin CA (GPMR6003)
- 2 oz. [60g] Medium CA+ (GPMR6009)
- 2 oz. [60g] Thick CA- (GPMR6015)
- CA Accelerator (GPMR6035)
- CA Debonder (GPMR6039)
- CA Applicator Tips (HCAR3780)
- 6-minute epoxy (GPMR6045)
- 30-minute (GPMR6047)
- Pro Wood Glue (GPMR6161)
- J & Z Products Z RC/56 canopy glue (JOZR5007)
- Microballoons (TOPR1090)
- Milled Fiberglass (GPMR6165)
- Lightweight Hobby Filler (HCAR3401)
- Auto body filler (Bondo® or similar)

- Denatured or Isopropyl Alcohol (to clean up excess epoxy)
- Masking Tape (TOPR8018, 8014, 8012)
- Wax Paper or Plan Protector (GPMR6167)
- #11 Blades (HCAR0311, 100 qty.)
- Single-Edge Razor Blades (HCAR0312, 100 qty.)
- T-Pins small (HCAR5100), medium (HCAR5150), large (HCAR5200)

TOOLS

- Sealing iron (TOPR2100)
- Razor Plane (MASR1510)
- Hobbico Builder's Triangle (HCAR0480)
- Drill Bits:
 - 1/16" [1.60mm] #48 [1.95mm] (or 5/64"),
 - 3/32" [2.40mm] 9/64" [3.60mm] (or 1/8"),
 - 1/8" [3.10mm] 5/32" [4.00mm]
 - 3/16" [4.70mm] 7/32" [5.60mm]
 - 1/4" [6.30mm] 17/64" [6.70mm]
 - #10 [4.90mm] or 13/64"
 - (or 1/4-20 tap and drill set)
 - #29 [3.40mm] or 9/64"
 - (or 8-32 tap and drill set)
- 1/4-20 Tap and drill (GPMR8105)
- 8-32 Tap and drill (GPMR8103)
- Tap wrench (GPMR8120)
- Kyosho® Lexan® Curved Scissors (KYOR1010)
- Long handle 9/64" ball end hex wrench (GPMR8004)
- Silver Solder (GPMR8070 w/flux)
- Easy-Touch™ Bar Sanders
- Heat Gun (TOPR2000)
- Trim Seal Tool (TOPR2200)
- Sealing Iron (TOPR2100)
- Hot Sock™ (TOPR2175)

EASY-TOUCH BAR SANDER



A flat, durable, easy-to-handle sanding tool is a necessity for building a well finished model. Great Planes makes a complete range of **Easy-Touch Bar Sanders** (patent pending) and replaceable **Easy-Touch Adhesive-backed Sandpaper**. While building the Spitfire we used two 5-1/2" [140mm] bar sanders and two 11" [280mm] bar sanders equipped with 80-grit and 150-grit adhesive-backed sandpaper. Here is the complete list of Easy-Touch Bar Sanders and adhesive-backed sandpaper:

5-1/2" [140mm] (GPMR6169)
 11" [280mm] (GPMR6170)
 22" [560mm] (GPMR6172)
 33" [835mm] (GPMR6174)
 44" [1118mm] (GPMR6176)

Contour Multi-Sander
 11" [280mm] (GPMR6190)

The **Easy-Touch Adhesive-Backed Sandpaper** is available in 2" x 12' rolls:

80-grit (GPMR6180)
 150-grit (GPMR6183)
 220-grit (GPMR6185)

Assortment of 5-1/2" [140mm] strips (GPMR6189)

We also use 320 or 400-grit wet-or-dry sandpaper for finish sanding.

IMPORTANT BUILDING NOTES

- There are two types of screws used in this kit.

Sheet metal screws are designated by a number and a length.

For example #6 x 3/4" [19.1mm]



Machine screws are designated by a number, threads per inch and a length.

For example 4-40 x 3/4" [19.1mm]

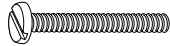

- When you see the term **test fit** in the instructions, it means that you should first position the part on the assembly **without using any glue**, then slightly modify or *custom fit* the part as necessary for the best fit.
- Whenever the term **glue** is used you should rely upon your experience to decide what type of glue to use. When a specific type of adhesive works best for that step we will tell you what type of glue to use.
- Whenever just **epoxy** is specified you may use **either** 30-minute epoxy **or** 6-minute epoxy. When 30-minute epoxy is **specified** it is **highly recommended** that you use only 30-minute (or 45-minute) epoxy because you will need the working time and/or the additional strength.
- Occasionally we refer to the *top* or *bottom* of the model or *up* or *down*. To avoid confusion, the *top* or *bottom* of the model is as it would be when the airplane is right side up and will be referred to as the top even if the model is upside down during that step, *i.e.* the top main spar is

always the top main spar even if the wing is upside down when you are working on it. Similarly, *move the former up* means move the former toward the top of the fuselage even if the fuselage is upside down when you are working on it.

- When you get to each step, read that step **completely through to the end** before you begin. Frequently there is important information or a note at the end of the step that you need to know before you start.
- **Photos** and **sketches** are placed **ahead** of the step they refer to. Frequently you can study photos in **following** steps to get another view of the same parts.

COMMON ABBREVIATIONS

Deg = degrees	Elev = elevator
Fuse = fuselage	" = inches
LE = leading edge	Ply = plywood
Stab = stabilizer	TE = trailing edge
LG = landing gear	mm = millimeters

TYPES OF WOOD

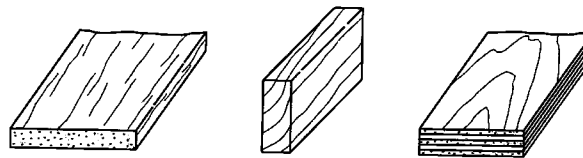

BALSA

BASSWOOD

PLYWOOD

METRIC CONVERSION

1" = 25.4mm (conversion factor)

1/64" = .4mm	1" = 25.4mm
1/32" = .8mm	2" = 50.8mm
1/16" = 1.6mm	3" = 76.2mm
3/32" = 2.4mm	6" = 152.4mm
1/8" = 3.2mm	12" = 304.8mm
5/32" = 4mm	15" = 381mm
3/16" = 4.8mm	18" = 457.2mm
1/4" = 6.4mm	21" = 533.4mm
3/8" = 9.5mm	24" = 609.6mm
1/2" = 12.7mm	30" = 762mm
5/8" = 15.9mm	36" = 914.4mm
3/4" = 19mm	

GET READY TO BUILD

1. Unroll the plan sheets. Roll them inside out so they lie flat.
2. Remove all the parts from the box. Use a ballpoint pen (not a felt tip pen) to lightly write the **name** or **size** on each piece so you can identify it later. Use the **die-cut patterns** on pages 8 & 9 to identify and mark the die-cut parts **before** you remove them from their die sheets. Many of the parts already have numbers stamped on them, but in some cases the number is located alongside the parts. You may remove all the die-cut parts from their die sheets now or wait until you need them. If a part is difficult to remove, don't force it out but cut around it with a #11 blade. After you remove the parts from their die sheets, lightly sand the edges to remove slivers or die-cutting irregularities. Save some of the larger scraps of wood.
3. Separate the parts into groups such as **stab**, **fin**, **wing**, and **fuse**. Zipper-top food storage bags are handy to store parts in as you sort, identify and separate them into subassemblies.

DIE-CUT PATTERNS

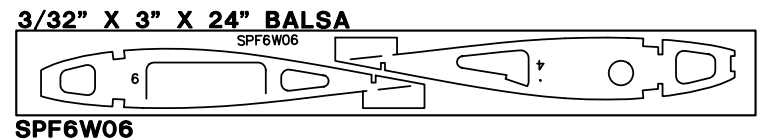
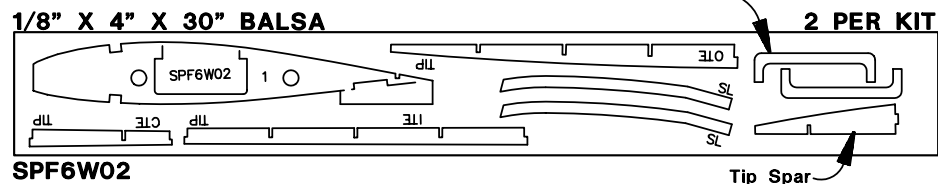
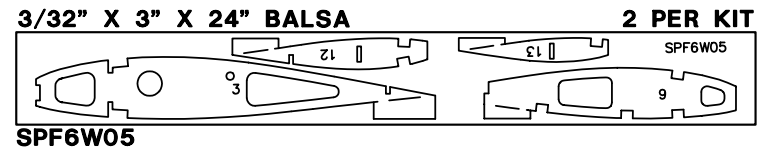
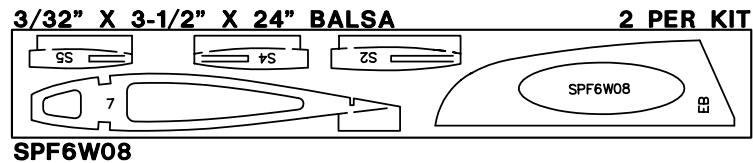
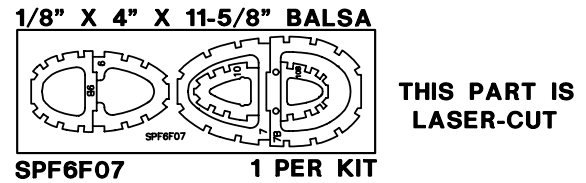
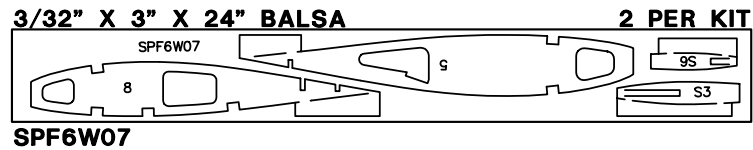
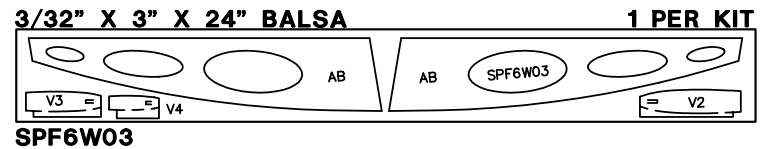
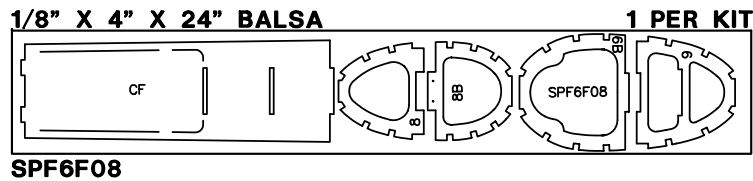
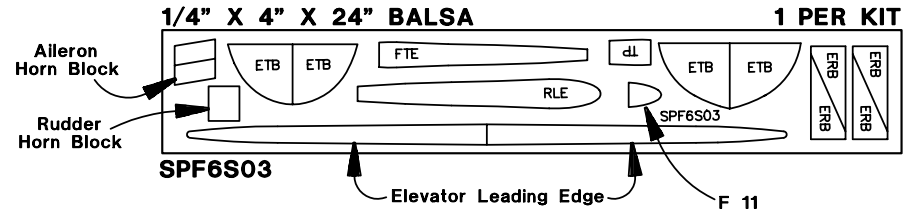
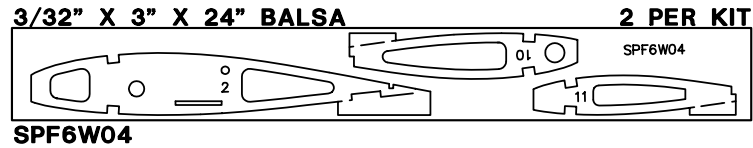
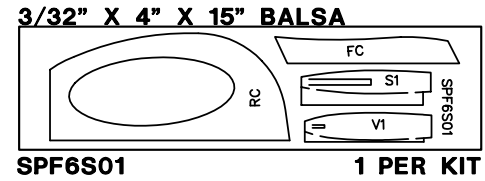
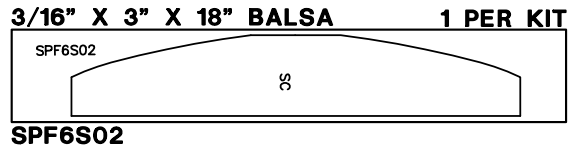

DIE-CUT PATTERNS

1/8" X 5" X 23-3/4" PLY 1 PER KIT

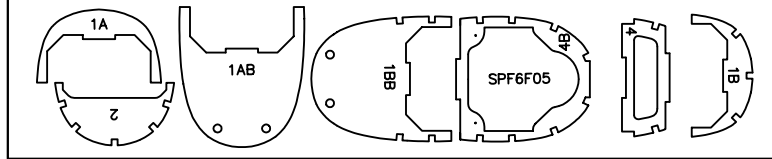

SPF6F05

1/16" X 4-1/8" X 20" BIRCH PLY 2 PER KIT

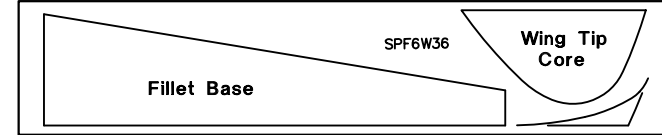

SPF6W36

1/8" X 4-5/8" X 23-3/4" PLY 1 PER KIT

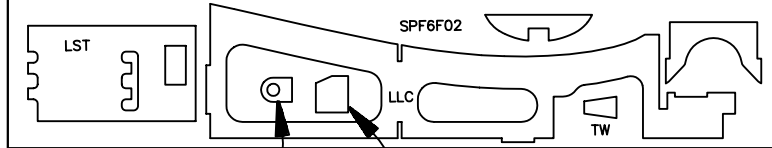

SPF6F02

Retract Valve Mount Plate
Elevator Horn Mount Plate

1/8" X 3-5/8" X 19" PLY 1 PER KIT

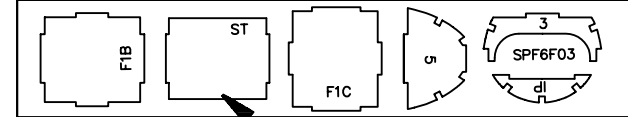

SPF6F03

Servo Mount Plate Base

1/8" X 4-5/8" X 19" PLY 1 PER KIT

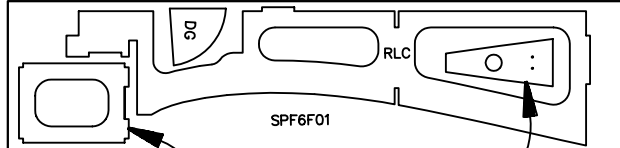

SPF6F01

Tank Floor
Tail Gear Plate

1/8" x 4-5/8" x 11-3/4" PLY

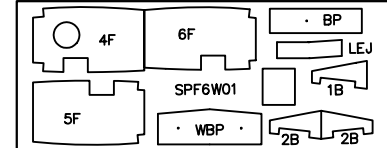

SPF6W01

2 PER KIT

1/8" x 4-5/8" x 11-3/4" PLY

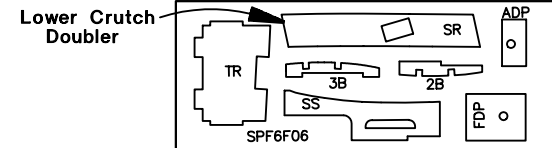

SPF6F06

2 PER KIT

Lower Crutch Doubler

1/8" X 3-3/4" X 19" PLY 1 PER KIT

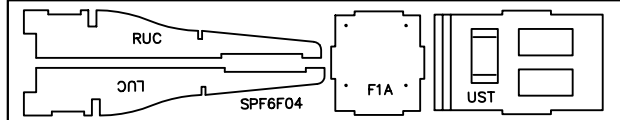

SPF6F04

1/8" x 5-1/8" x 8-1/2" Birch Ply

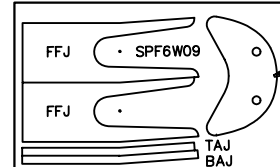

SPF6W09 1 PER KIT
This part is Laser-Cut

Wing Dowel Doubler

1/8" X 4-1/8" X 9-3/8" PLY

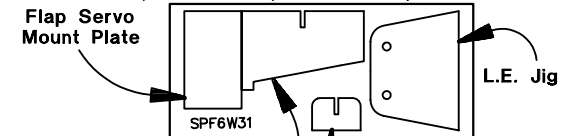

SPF6W31 2 PER KIT

T.E. Jig

1/16" X 5-1/8" X 20" BIRCH PLY 2 PER KIT

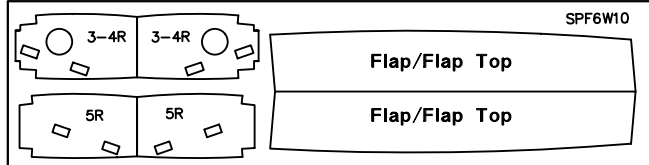

SPF6W10

1/8" X 4-1/8" X 15-3/4" PLY



SPF6W30

2 PER KIT

Tip Jigs
Radiator Braces

BUILD THE TAIL SURFACES

BUILD THE STAB

❑ 1. Use your own method or the **Hot Tip** that follows to glue two 1/16" x 3" x 30" [1.6 x 76 x 762mm] balsa sheets together to make a 6" x 30" [152 x 762mm] sheet for the top and bottom **stab skins**.

Top Flite selects balsa that is intended for sheeting, though occasionally a few of these sheets may have a small nick or split near the ends. If your kit contains a few of these sheets, arrange them and glue them together so the defects will not interfere with the final shape of the skin.



HOW TO MAKE THE STAB SKINS

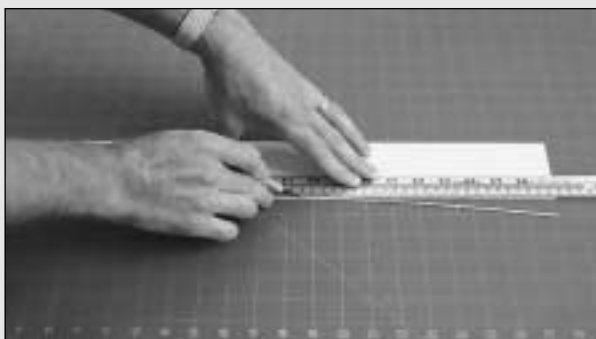

❑ A. Use a straightedge and a sharp #11 blade to true one edge of both sheets. Do not cut all the way through the first time but make several passes with your knife to prevent the wood from splitting.

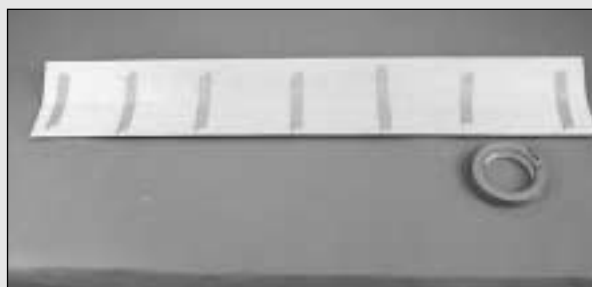

❑ B. Tightly tape the sheets together with masking tape.



❑ C. Place a sheet of waxed paper on your workbench. Turn the taped together sheets over and apply aliphatic resin (wood workers glue such as Great Planes Pro) to the seams.

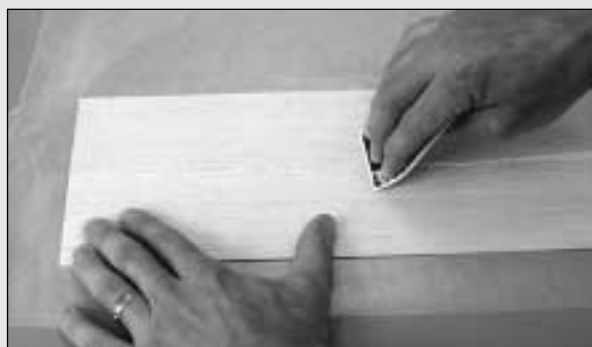

❑ D. Use a credit card or something similar to simultaneously press the sheets flat as you squeegee the excess glue from the seam. Wipe the glue off your squeegee so it's ready for the next time. Immediately proceed to the next step.



CROSS SECTION OF GLUE JOINT

INCORRECT: SHEETS NOT FLAT AND EVEN

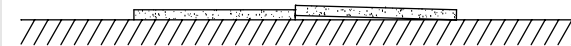

CORRECT: SHEETS ARE FLAT AND EVEN

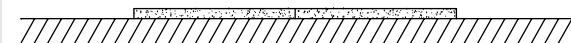

❑ E. Inspect the seam and press the sheets together where they do not align.

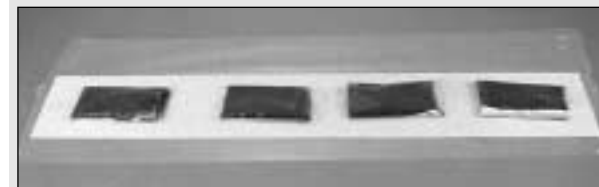

❑ F. Place weights on top of the sheets to hold them down. We prefer plastic bags filled with lead shot, but anything similar will do the job.

❑ G. After the glue dries, remove the masking tape and sand the sheet flat with your bar sander and 150-grit sandpaper. The idea is to sand the sheeting **before** you glue it to the structure. This eliminates low spots that can occur over the wing ribs from sanding too much after you glue the sheeting in place.

This is the same procedure we will recommend when it is time to make the wing skins.

❑ 2. While you're making skins, make a 6" x 15" [152 x 381mm] **fin skin** by cutting a 1/16" x 3" x 30" [1.6 x 76 x 762mm] balsa sheet in half and gluing the two pieces together. Set the skins aside for now.

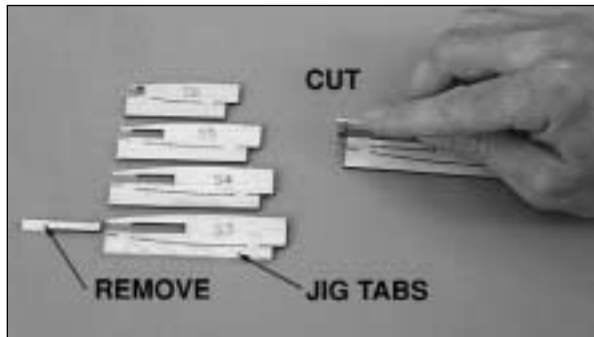

❑ 3. Carefully cut along the partially die-cut lines in the front of the die-cut 3/32" [2.4mm] balsa **stab ribs** and remove the pieces of balsa to accommodate the stab core. Leave the jig tabs in place on the bottom of the ribs.

❑ 4. Position the fuse plan so the stab plan is over your building board, or cut the stab from the plan and tape it to your building board. Cover the stab plan with waxed paper.

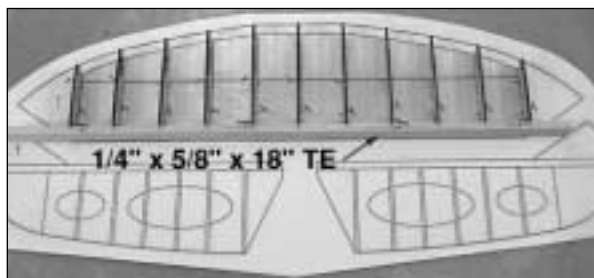

❑ 5. Temporarily pin a 1/4" x 5/8" x 18" [6.4 x 15.9 x 457mm] balsa **stab TE** over the stab TE on the plan. This will help you accurately position the stab ribs until you raise the TE and glue it in place. Use **small** T-pins to pin the stab ribs over their location on the plan so they contact the stab TE. Insert the T-pins through the ribs so they will not interfere with the stab core.



Use this photo for the next two steps.

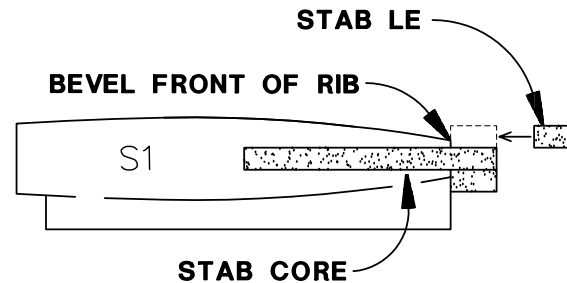

❑ 6. Use medium CA to glue the die-cut 3/16" [4.8mm] balsa **stab core** in the notches of the ribs. Bevel the fronts of the ribs so the die-cut 3/32" [2.4mm] balsa **stab leading edges** will align with the front of the stab core. Glue the stab leading edges to the top of the stab core.

Note: Refrain from using CA accelerator, or use it sparingly. Residual accelerator can make the CA you use in the following steps cure quickly and unexpectedly—even if has been sprayed on hours before.

❑ 7. Remove the stab TE from your building board and trim it to the length shown on the plan. Center the TE on the ends of the ribs and glue it in position.

❑ 8. Use the **stab skin template** on the plan to make the top and bottom stab skin from the 1/16" [1.6mm] sheets you glued together earlier.

❑ 9. Trim the LE of one of the stab skins so it accurately fits the stab leading edges. Slightly bevel the LE of the skin to match the angle at which it contacts the stab LE's.

❑ 10. Trim the top of the stab TE so it is even with the tops of the ribs. Remove all the T-pins except the ones in tip ribs S6. Make sure none of the T-pins will be concealed under the stab sheeting so you will be able to remove the stab after you glue the sheeting in place.



❑ 11. Glue the stab skin to the top of the stab. We recommend thin CA for the leading edge of the skin and aliphatic resin for the ribs and TE. Use weights and T-pins to hold the skin down until the glue cures.

❑ 12. Remove the weights and T-pins and trim the stab skin so it is even with the tips and TE. Glue the bottom of the ribs to the stab core, then carefully cut the jig tabs from the bottom of the ribs.

❑ 13. Cut six 1" [25mm] long **hinge blocks** from the 1/4" x 1/2" x 12" [6.4 x 12.7 x 305mm] balsa stick. Glue the hinge blocks to the stab TE where shown on the plan. Trim the TE so it is even with the ribs and lightly sand the bumps of the ribs left from the jig tabs. You can see the hinge blocks in the next photo.

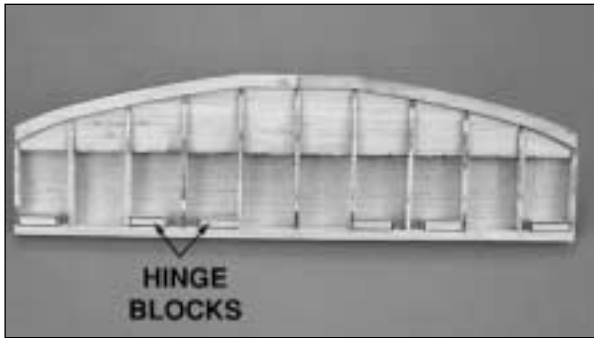

14. Trim the front of the ribs to accommodate the bottom stab leading edges the same way you did the top. Glue the stab leading edges to the stab core.

15. Test fit and glue the bottom stab skin to the bottom of the stab. As you do this, use care not to add any twist to the stab as it is no longer supported by the jig tabs. If you haven't used too much accelerator, you could use medium or thick CA and hold the skin in position with your hands until the CA cures.

16. Trim the bottom skin so it is even with the tips and stab TE. Roughly trim the stab leading edge so it is even with the sheeting and resembles the cross section on the plan but do not sand it to final shape yet.

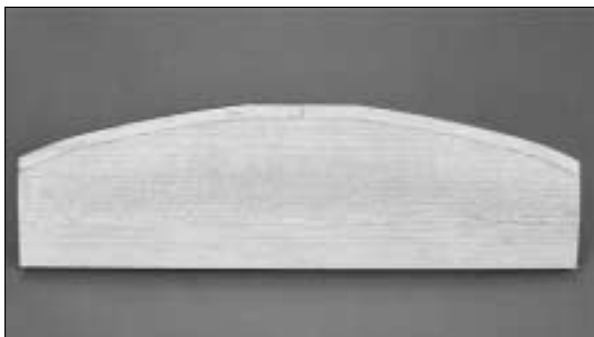

What a nice piece of workmanship. I bet you don't need any filler at all! You're off to a good start so let's move on to the elevators.

BUILD THE ELEVATORS

Note: The die-cut elevator bases included in the kit have **one** large lightening hole instead of the two smaller ones shown in the instruction manual photos. This is to reduce the weight in the tail. Start with the left elevator.

1. Position one of the die-cut 3/32" [2.4mm] balsa **elevator bases** over the elevator plan and lightly mark the location of the elevator ribs on the base.

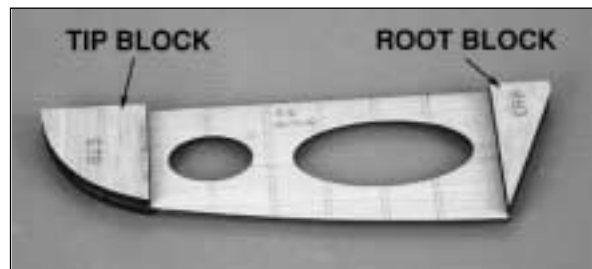

2. Glue a die-cut 1/4" [6.4mm] balsa **elevator tip block** and a die-cut 1/4" [6.4mm] balsa **root block** to both sides of the elevator base as shown.

3. Glue the elevator base, on center, to a die-cut 1/4" [6.4mm] balsa **elevator leading edge**. You can see it in the next photo.



4. Sand the elevator root blocks and the elevator tip blocks to a *wedge* so they match the cross section on the plan. Sand the top and bottom of the elevator LE to match the root and tip blocks. **Do not** sand the "V" on LE of the elevator and do not round the tips until instructed to do so.



5. Insert a T-pin through the **center** of the elevator LE near the tip and near the root. Place a straightedge across the T-pins and draw a **centerline** on the elevator LE with a ballpoint pen. Draw a centerline along the TE of the stab the same way.

6. Glue one of the shaped 5/8" [15.9mm] balsa **stab tip blocks** to the left side of the stab.

7. Mark the center of the stab on the TE and the location of the elevator roots where shown on the plan (refer to the following photo). Use thick or medium CA to *tack glue* the elevator to the stab—just a drop in three or four places. Add a few pieces of masking tape for a little extra security. Make sure the elevator is **centered** vertically on the stab.

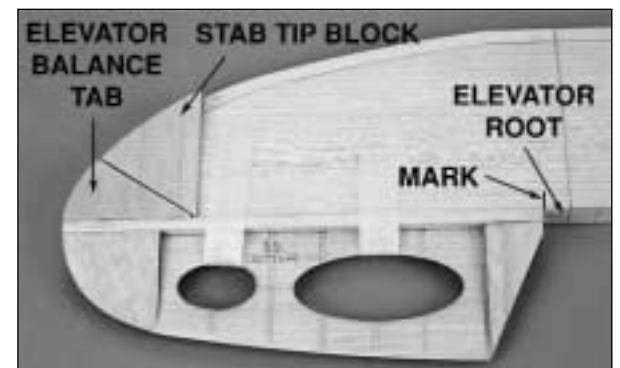

8. Glue the shaped 5/8" [15.9mm] balsa **elevator balance tab** to the elevator LE with medium or thick CA. There should be approximately a 1/16" [1.6mm] gap between the elevator balance tab and the stab tip.

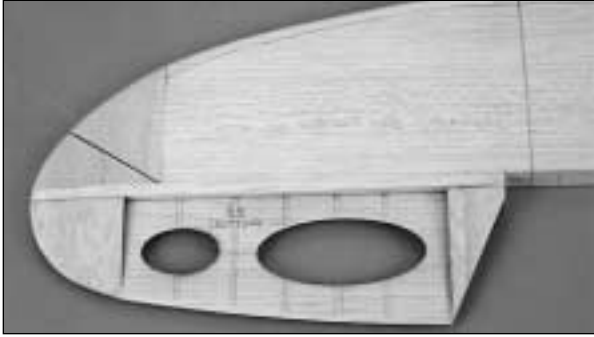

□ □ 9. Use a razor plane and your bar sander with 80-grit sandpaper to sand the elevator and stab tips as shown on the plan. Avoid sanding the 1/16" [1.6mm] stab sheeting. Proceed slowly, removing small amounts of material at a time and inspect your work frequently.

□ 10. Return to step 7 and build the right elevator the same way.

Note: It is more important that the elevator tips match **each other** rather than match the plans perfectly. As you proceed, compare the right tip to the left tip to make sure they are identical.

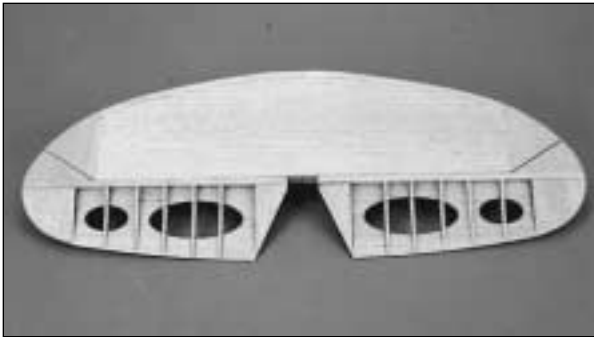

□ 11. Use three 3/32" x 3/8" x 24" [2.4 x 9.5 x 610mm] balsa sticks to make the **elevator ribs** and glue them to the side of the elevators where you marked the locations of the ribs. Glue the ribs to the other side of the elevators matching them to the ribs you already glued. Shape the ribs to match the shape of the root and tip blocks and the cross section on the plan.

□ 12. Round the leading edge of the stab as shown on the cross section of the plan, blending it to the stab tips.

□ 13. Carefully *break* both elevators free from the stab. Notice which elevator matches which side of the stab. Remove any *glue bumps* left from the CA you used to tack glue the elevators to the stab.

IMPORTANT NOTES ABOUT CA HINGES

This kit is supplied with a CA hinge material consisting of a 3-layer lamination of mylar and polyester. It is specially made for hinging model airplane control surfaces. When properly installed, this type of CA hinge provides the best combination of strength, durability and easy installation. We trust all of our Gold Edition warbirds to these hinges, but **it is essential to install them correctly**. Carefully follow the hinging instructions in this manual for the best result.

The most common mistake made by modelers when installing CA hinges is making the hinge slots too tight restricting the flow of CA to the back of the hinges; or not using enough glue to fully secure the hinge over its entire surface area. This results in hinges that are only *tack glued* into the hinge slots. The techniques for cutting the hinge slots and gluing in CA hinges (near the end of the manual) have been developed to ensure thorough and secure gluing.

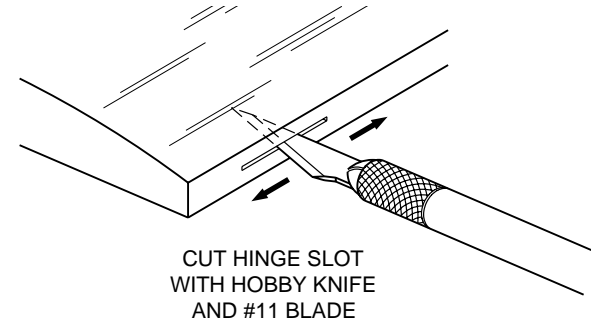

□ 14. Mark the location of the hinge slots on the elevators and stab where shown on the plan. Glue pieces of leftover 3/32" [2.4mm] balsa to both sides of the elevator bases over the location of the hinge slots (see the photo at step 19). Cut the hinge slots in the elevators and the stab along the centerlines you marked earlier with a #11 blade.

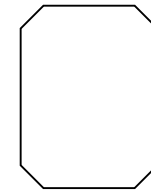
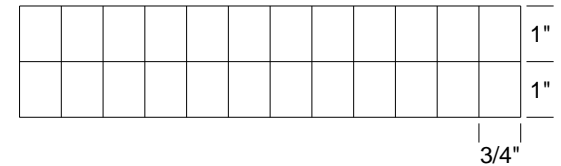

□ 15. Using the sketch above, cut six hinges from the **CA hinge strip** supplied with this kit. Snip the corners off so they go into the slots easier. You may cut all sixteen hinges now, or just cut them as you need them.

□ 16. Test fit the hinges into the slots. If the hinges do not slide into the slots easily, work your knife blade back and forth in the slot a few times to provide more clearance (it is really the **back edge** of the blade that does the work here in widening the slot).

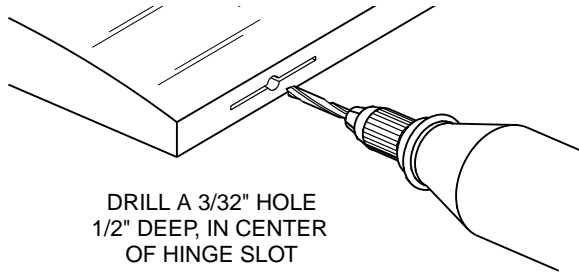

- ❑ 17. Drill a 3/32" [2.40mm] hole, 1/2" [13mm] deep in the center of the hinge slots. Use a rotary tool with a 3/32" [2.40mm] drill bit or a carbide cutter for the best results. Reinsert your knife blade to *clean out* the slot after you drill the holes.

- ❑ 18. Test fit the elevators to the stab with the hinges.



- ❑ 19. Position the **elevator joiner** on the TE of the stab and center it between the elevators. Mark the LE of both elevators where the joiner will enter.

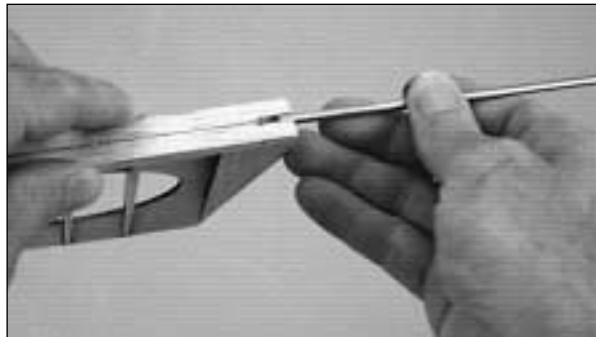

- ❑ 20. Drill a 9/64" [3.60mm] (or 1/8") hole at the marks you made on the centerline of both elevator

leading edges. Cut a slot in the leading edge of both elevators to accommodate the joiner wire.
Hint: Use a 5/32" [4mm] brass tube sharpened at one end to cut the slots.

- ❑ 21. Bevel the leading edges of the elevators to a "V" as shown on the cross section of the plan. Use the centerline on the elevator leading edges as a guide. Test fit the elevators to the stab with the joiner wire and hinges. If necessary, remove the joiner and *tweak* it so both elevators are in the same plane.

- ❑ 22. Round the root ends of the elevators.

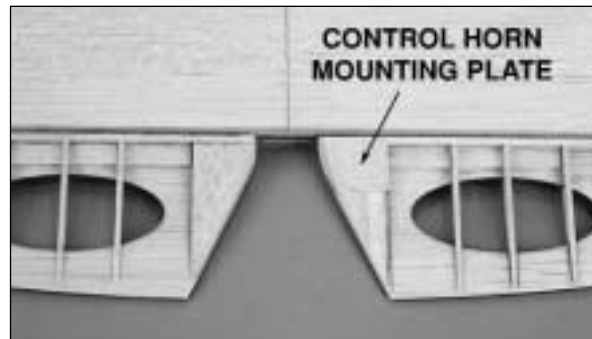

**ELEVATOR
VIEWED FROM ROOT**

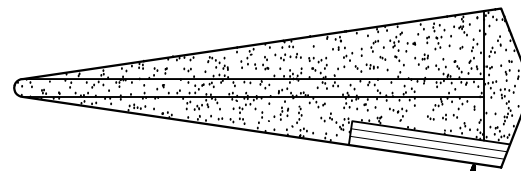

**CONTROL HORN
MOUNTING PLATE**

- ❑ 23. Remove material from the bottom of the left elevator root block to accommodate the die-cut 1/8" [3.2mm] plywood **control horn mounting plate**. Securely glue the mounting plate to the root block and sand it to blend with the rest of the elevator.

**BEVEL THE ELEVATOR
BALANCE TAB
IF NECESSARY**

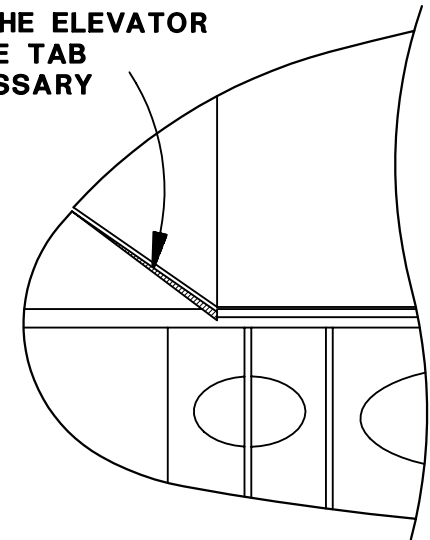

- ❑ 24. Once more, test fit the elevators to the stab with the hinges. Make sure you can obtain the control throws indicated in the back of the manual. If you cannot, increase the "V" on the leading edge of the elevators. If the gap between the elevator balance tab and the stab tip block is the source of interference, increase the gap or bevel the elevator balance tab as shown in the sketch until you can obtain the indicated elevator throw.

Set the stab and elevators aside.

BUILD THE FIN

- ❑ 1. Position the fuse plan so the fin plan is over your building board and cover it with wax paper.
- ❑ 2. Carefully cut along the partially die-cut lines in the front of the die-cut 3/32" [2.4mm] balsa **fin ribs** and remove the pieces of balsa to accommodate the die-cut 3/32" [2.4mm] balsa **fin LE core** (the same way you did for the stab ribs).

❑ 3. See the following photo and temporarily pin the remainder of the 1/4" x 1/2" [6.4 x 12.7mm] balsa stick you used for the stab hinge blocks (it should be about 6" [150mm] long) to your building board over the TE of the fin plan. This will help you accurately position the fin ribs until you actually glue the fin TE in position. Use **small** T-pins to pin the fin ribs over their location on the plan so they contact 1/4" x 1/2" [6.4 x 12.7mm] balsa stick.

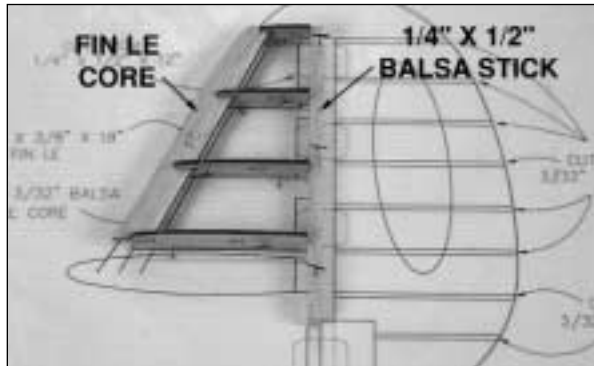

❑ 4. Use medium CA to glue the fin LE core in the notches of the ribs.

❑ 5. Cut 6" [150mm] from the 3/16" x 3/8" x 18" [4.8 x 9.5 x 457mm] balsa stick for the **fin LE**. Trim the fronts of the ribs at the same angle that the fin LE will contact them. Glue the fin LE to the left side (top) of the fin LE core so the excess extends below rib V1 (see the following photo).

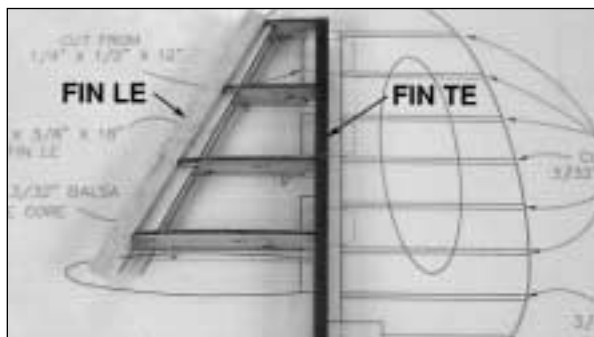

❑ 6. Remove the 1/4" x 1/2" [6.4 x 12.7mm] balsa stick you had pinned over the fin TE. Center the

die-cut 1/4" [6.4mm] balsa **fin TE** on the fin ribs and glue it in position.

❑ 7. Cut the fin skin for the left side of the fin from the 1/16" x 6" x 15" [1.6 x 152 x 381mm] balsa sheet you prepared earlier. The grain is parallel to the fin LE and **the skin should extend below rib V1 by approximately 1/4" [6mm]** to be trimmed later.

Hint: Once you make the fin skin for the left side of the fin, use it as a template to make the skin for the right side of the fin.



❑ 8. Remove the T-pins and glue the fin skin to the left side of the fin.

❑ 9. Turn the fin over and glue the right side of the ribs to the fin LE core, then carefully cut the jig tabs from the bottom of the ribs.

❑ 10. Cut three 1" [25mm] long **hinge blocks** from the 1/4" x 1/2" [6.4 x 12.7mm] balsa stick you had temporarily pinned to the plan at the fin TE. Glue the hinge blocks to the fin TE where shown on the plan. Trim the TE and the hinge blocks even with the ribs and lightly sand the bumps of the ribs left from the jig tabs.

❑ 11. Cut another 6" [150mm] long fin LE from the 3/16" x 3/8" [4.8 x 9.5mm] balsa stick. Trim the front of the ribs to accommodate the fin LE the same way you did the other side. Glue the fin LE to the fin LE core.

❑ 12. If you haven't already done so, cut the other fin skin. Glue the fin skin to the right side of the fin so the sheeting extends 1/4" [6mm] below V1.

❑ 13. Trim the fin skins even with tip rib V4 and the fin TE. Trim the leading edge of the fin so it is even with the LE core, then shape the LE as shown on the cross section of the plan.

BUILD THE RUDDER

❑ 1. Position the die-cut 3/32" [2.4mm] balsa **rudder base** over the plan and lightly mark the location of the ribs on the base.

❑ 2. Use a straightedge and a ballpoint pen to mark a centerline on both sides of the die-cut 1/4" [6.4mm] balsa **rudder LE**. Glue the rudder base to the rudder LE on the centerline.

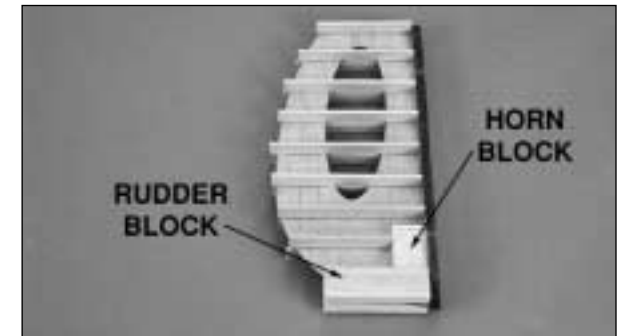

Use this photo for the next three steps.

❑ 3. Glue the 3/8" x 3/4" x 2-3/8" [9.5 x 19.1 x 60.5mm] **rudder blocks** to both sides of the bottom of the rudder base. You will shape them to match the bottom of the rudder later.

❑ 4. Glue a piece of leftover 1/16" [1.6mm] balsa to one side of the die-cut 1/4" [6.4mm] balsa **horn block** to increase its total thickness to 5/16" [7.9mm]. Glue the balsa horn block to the right side of the rudder base where shown on the plan.

5. Cut the **rudder ribs** from two 3/32" x 3/8" x 24" [2.4 x 9.5 x 610mm] balsa sticks and one 3/32" x 1/2" x 12" [2.4 x 12.7 x 305mm] balsa stick (for the bottom two rudder ribs on each side) and glue them to the rudder base.

6. Sand the rudder ribs and the rudder blocks so they match the cross section on the plan. **Do not** sand the "V" on LE until instructed to do so.

7. Hold the rudder to the fin and position the shaped 1/2" [12.7mm] balsa **rudder tip block** on top of the rudder. View the gap between the bottom of the rudder tip block and the top of the fin. Sand the top of the rudder if necessary so the gap is even. Set the rudder tip block aside for now.

8. Glue pieces of leftover 3/32" [2.4mm] balsa to the rudder base over the locations of the hinge slots. Draw a centerline on the TE of the fin. Cut the hinge slots on the centerline of the fin TE and the rudder LE where shown on the plan.

9. Test fit the rudder to the fin with the hinges.

10. Using the centerline on the front of the rudder LE as a guide, shape the LE of the rudder to a "V" as shown on the cross section.

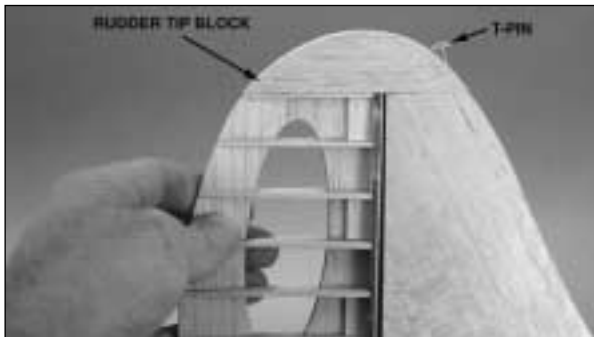

11. Glue the rudder tip block to the rudder and shape it to match the plan and the fin.

Hint: After you glue the rudder tip block to the rudder, temporarily join the rudder to the fin. Align

the rudder tip block with the tip of the fin and hold it in place with a T-pin. Sand the tip block to match the fin. Remove the T-pin and round the rudder tip block to match the plan.

12. Notch the right side of the rudder to accommodate the die-cut 1/8" [3.2mm] plywood **control horn mounting plate** and glue it in place. Sand the mounting plate to blend with the rudder LE.

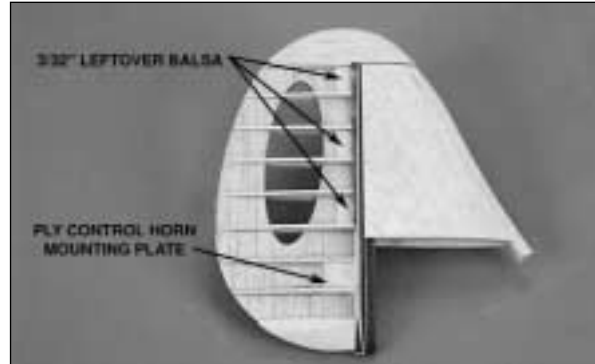

When you're done, your fin and rudder should look something like this.

Alright, enough of this kid stuff. Lets get into the meat of this project! Clean off your workbench, vacuum the floor and start building the wing!

BUILD THE WING



If you are installing retracts and have purchased your landing gear (or as soon as you do), take the air lines out of the package, unravel them and hang them somewhere in your shop. This will get all the kinks out so the lines will be easier to install later.

PREPARATIONS

Perform steps 1, 2 and 3 only if you are building flaps.

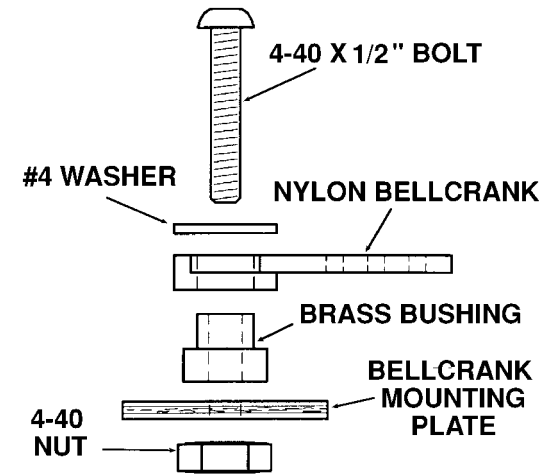
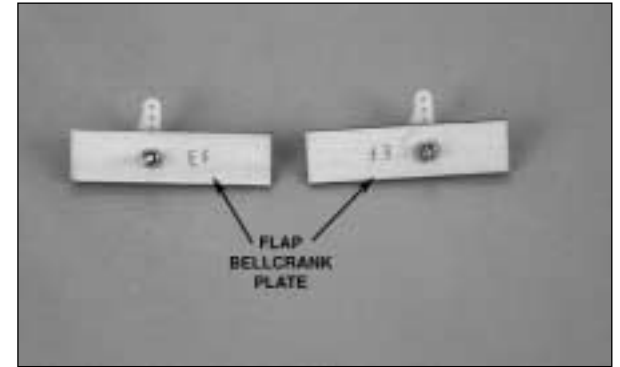

1. Drill a 1/8" [3.10mm] hole through the punch mark in both die-cut 1/8" [3.2mm] plywood **flap bellcrank plates**. Assemble the bellcranks as shown in the sketch with the hardware supplied with this kit. Secure the 4-40 nut with a drop of epoxy or thread lock.



❑ 2. Mark rib 4 at the center of the leading edge. Lay a straightedge on the rib across the mark you made and the trailing edge of the rib where it comes to a point. Draw a short line along the straightedge from the trailing edge of the rib to the notch for the inner trailing edge. This is where you will cut the bottom of the ribs (when instructed to do so) to accommodate the flap.

❑ 3. Do the same with the other rib 4 and ribs 5 through 8 for both wing panels.

Perform step 4 only if you are building retractable landing gear.

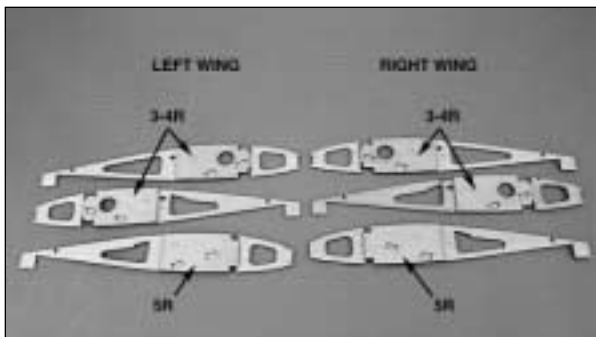

❑ 4. Glue the die-cut 1/16" [1.6mm] plywood **rib doublers 3-4R** and **5R** to both sets of die-cut 3/32" [2.4mm] balsa wing ribs 3, 4 and 5. Make sure you build a set of **right** and a set of **left** wing ribs by gluing the doublers to the correct side of the ribs as shown on the plan and in the photo.

Note: Ribs 3 and 4 have doublers on one side only, but rib 5 has doublers on both sides.

Perform step 5 only if you are building fixed landing gear (a scale warbird without retracts? Won't you reconsider?).

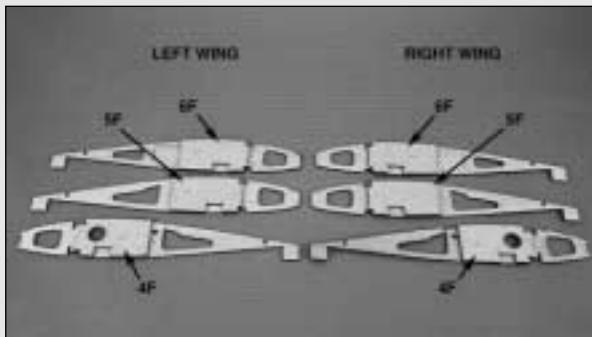

❑ 5. Glue the die-cut 1/8" [3.2mm] plywood **rib doublers 4F**, **5F** and **6F** to both sets of die-cut 3/32" [2.4mm] balsa wing ribs 4, 5 and 6. Make sure you build a set of **right** and a set of **left** wing ribs by gluing the doublers to the correct side of the ribs as shown on the plan and in the photo.

❑ 6. Remove balsa within the notches of the plywood doublers to accommodate the landing gear rails.

BUILD THE OUTER WING PANELS

Build the left wing panel first so yours will look the same as the photos.

❑ ❑ 1. Cut the left wing panel from the plan or position the plan so the left wing panel is over your building board. Cover the left wing panel plan with wax paper.

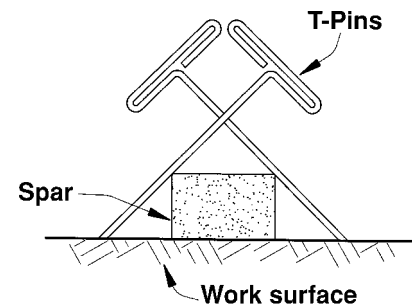

❑ ❑ 2. Position a 1/4" x 3/8" x 24" [6.4 x 9.5 x 610mm] basswood **bottom main spar** over its location on the plan, aligning the tip of the spar with the plan. Place a piece of leftover 1/16" [1.6mm] balsa under the spar about 1/2" [12.7mm] from the root end (refer to the following photo). Pin the spar to the plan between ribs 4 and 5 and between ribs 12 and 13. Don't stick your pins *through* the spar but stick them into your building board over the spar in a *crisscross* fashion.

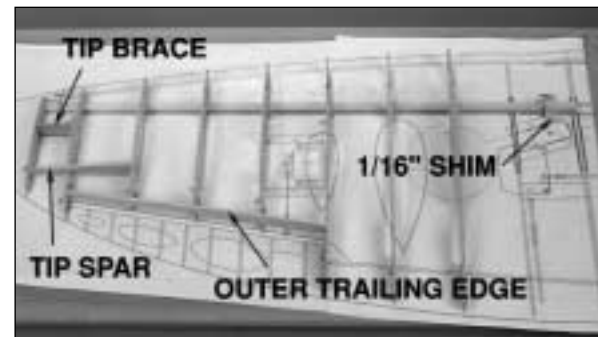

❑ ❑ 3. Position ribs 6 through 12 on the bottom spar over their location on the plan. Pin each rib to the plan in two places—one at the lowest point where they contact the plan and one at each jig tab. As you pin the ribs down, make sure you align the spar over the plan. Add the die-cut 1/8" [3.2mm] plywood **tip brace**, rib 13, the die-cut 1/8" [3.2mm] balsa **outer trailing edge** and the **tip spar** to the assembly.

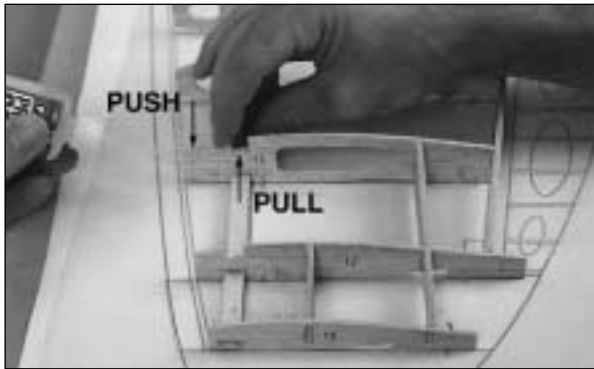

☐☐ 4. Remove the T-pins from the spar and glue the ribs to it. As you glue each rib, simultaneously *pull* the spar up into the notch in the rib and *push* the rib down to your building board. This will ensure that the spar is fully *seated* in the rib notches. Glue the outer spar, the tip spar and the tip brace to the ribs.

☐☐ 5. Cut 1-7/8" [48mm] from a 1/4" x 3/8" x 24" [6.4 x 9.5 x 610mm] basswood **top main spar**. Fit the spar in the notches in the top of the ribs and glue it **only** to ribs 11 and 12. Notice that the top spar *ends* at the outboard edge of rib 12.

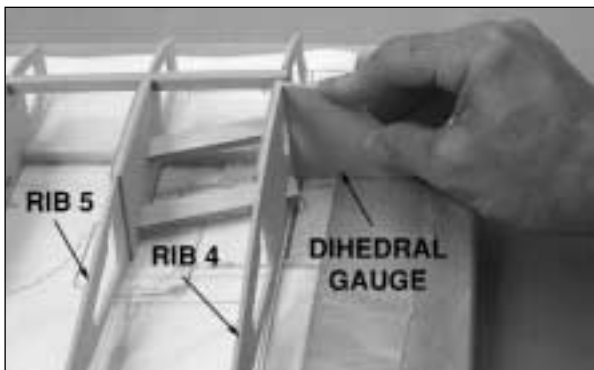

☐☐ 6. Test fit ribs 4 and 5 and the 1/4" x 7/16" x 3-1/2" [6.4 x 11.1 x 89mm] plywood **landing gear rails** to the wing panel (if you are not installing retracts, disregard the landing gear rails). Use the die-cut 1/8" [3.2mm] plywood **dihedral gauge** to

set rib 4 at the correct angle. Make sure the notches in the ribs for the landing gear rails allow the rails to go in at an angle as indicated on the plan. Enlarge the notches if necessary.

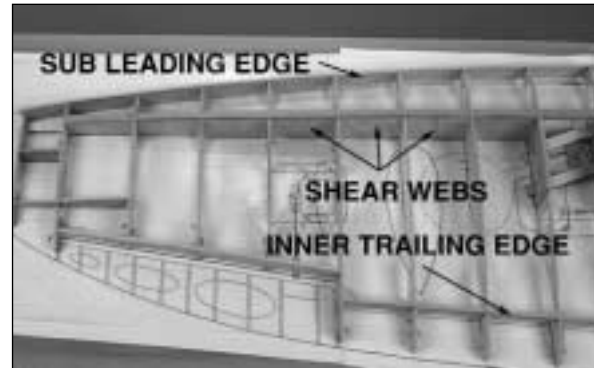

Use this photo for the next four steps.

☐☐ 7. After you are satisfied with the way the landing gear rails and ribs 4 and 5 fit together, pin rib 5 to your building board over the plan and add the die-cut 1/8" [3.2mm] balsa **inner trailing edge** to the assembly. Glue rib 5 to the bottom spar and glue the inner trailing edge to ribs 5, 6, 7 and 8. Glue the top spar to all the ribs except rib 4.

☐☐ 8. Confirm that rib 4 aligns with its location over the plan and set it at the correct angle with the dihedral gauge. Leave the landing gear rails in position but do not glue them in place until instructed to do so. Glue rib 4 to the inner trailing edge and the top and bottom spars.

☐☐ 9. Cut the 1/8" x 1" x 36" [3.2 x 25.4 x 914mm] balsa **sub leading edge** to a length of 24-1/2" [623mm]. Save the short piece for the sub leading edge when you build the center section. Carefully sand a bevel on the fronts of the ribs for a better glue joint to the sub leading edge. Glue the sub LE to the front of ribs 4 through 13 as shown on the plan.

☐☐ 10. Test-fit, then glue the pre-cut 1/16" [1.6mm] **shear webs** to the spars where shown on the plan.

Note: The spars are slightly *tilted* to match the airfoil of the wing so the shear webs do not fully contact them. This presents no problems because we will remind you to reinforce the glue joints before you sheet the wing.

☐☐ 11. Trim the top of the sub leading edge so it is even with the ribs to accommodate the top sheeting. Sand the top spar and the outer and inner TE's even with the ribs.

☐☐ 12. Remove the wing panel from your building board. Make sure the shear webs are securely glued to the spars. Add CA where necessary.

☐☐ 13. Carefully cut the jig tabs from the bottom of the ribs. Trim the bottom of the sub leading edge so it is even with the ribs. Sand the bottom spar and outer and inner TE's even with the ribs. Sand the ends of the spars and the LE even with *tip rib 13* and *root rib 4*.

☐☐ 14. Return to step one and build the right wing panel the same way.

BUILD THE CENTER SECTION

- ❑ 1. Align the center section wing plan over your building board and cover it with waxed paper.

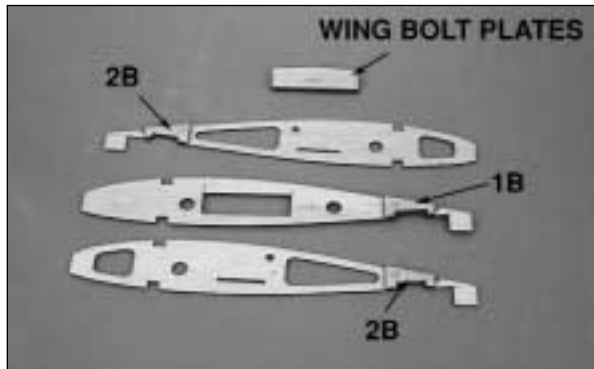

- ❑ 2. Glue the die-cut 1/8" [3.2mm] plywood **rib doublers 1B** and **2B** to rib 1 and both 2's respectively as shown on the plan. Glue both die-cut 1/8" [3.2mm] plywood **wing bolt plates** together.

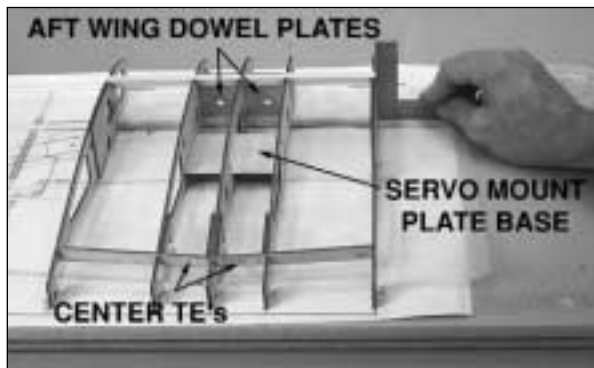

Use this photo for the next six steps.

- ❑ 3. Cut the top and bottom **center section spars** to the length shown on the plan from the 1/4" x 3/8" x 24" [6.4 x 9.5 x 610mm] basswood stick. Place the bottom spar over its location on the plan and pin it to your building board.
- ❑ 4. Place the ribs of the center section over the plan on the bottom spar. Place both die-cut 1/8" [3.2mm] plywood **aft wing dowel plates** and the

die-cut 1/8" [3.2mm] plywood **servo mount plate base** between the #2 ribs. The holes in the dowel plates are closest to the **bottom** of the wing.

- ❑ 5. Add both die-cut 1/8" [3.2mm] balsa **center TE's** and the top spar.
- ❑ 6. Pin the ribs to your building board the same way you did for the outer panels (pin down the jig tabs and the *low point* of the ribs).
- ❑ 7. Make sure the ribs are in the correct location with the doublers as shown on the plan. Remove the T-pins that are holding the bottom spar down. Pull the bottom spar up into the notches of the ribs and glue it to the ribs the same as you did for the outer panels. Avoid gluing the aft dowel plates at this time.

Note: Make sure both #3 ribs are vertical when you glue them to the spars.

- ❑ 8. Align the top edge of both aft dowel plates with the top spar and glue them in position. Glue the rest of the joints made by the ribs, the top spar, the servo plate and the center TE's.

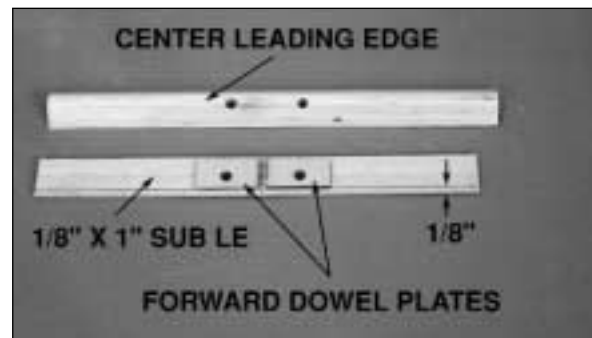

Use this photo for the next two steps.

- ❑ 9. Use a straightedge to draw a line 1/8" [3mm] from the edge of a leftover 1/8" x 1" [3.2 x 25.4mm] sub LE you used for one of the outer panels. Glue both die-cut 1/8" [3.2mm] plywood **forward dowel plates**, centered, to the sub LE, aligning them with

the line you marked with a 1/8" [3.2mm] space between them (to accommodate center rib 1).

- ❑ 10. Cut a 10" [250mm] **center leading edge** from the 36" [914mm] long shaped balsa leading edge stock. Center the sub LE on the back of the center leading edge and tape them together. Use the holes in the forward dowel plates as a guide to drill 1/4" [6.30mm] holes through the sub leading edge and the center leading edge for the 1/4" [6.4mm] wing dowels.



- ❑ 11. Glue only the sub LE to the front of the ribs with the forward dowel plates centered on ribs 1 and 2.
- ❑ 12. The same way you did for the outer panels, trim the top of the sub LE to accommodate the top sheeting.
- ❑ 13. Remove any T-pins that will be concealed under the sheeting after you glue it to the top of the center section.
- ❑ 14. Cut ten 9-1/2" [242mm] long sheets from four 1/16" x 3" x 30" [1.6 x 76 x 762mm] balsa sheets. Make two 15" x 9-1/2" [380 x 242mm] **center section skins** by gluing together two sets of five sheets.
- ❑ 15. Glue one of your skins to the top of the center section. The front should extend past the LE by approximately 1/16" [1.6mm] and the TE should extend past the end of the ribs by 3/8" [9.5mm].

- ❑ 16. Take the center section off of your building board.

Perform steps 17 through 21 only if you are building flaps.

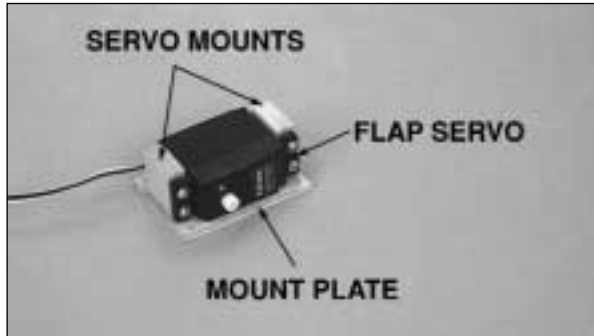

- ❑ 17. Mount your flap servo to two 5/16" x 3/4" x 7/8" [7.9 x 19.1 x 22.2mm] hardwood **servo mounts** with the screws included with your servo. Use 30-minute epoxy to glue the servo mounts to the die-cut 1/8" [3.2mm] plywood **mount plate**.

- ❑ 18. Make a one-arm servo horn from one of your standard servo horns by cutting off the extra arms. Insert a 0-80 **ball screw** in your servo arm. Secure the ball screw with a drop of thread lock and a 0-80 **hex nut**.



- ❑ 19. Cut an opening in the top sheeting and trim rib 1 as necessary to accommodate your flap servo and the mount plate.

- ❑ 20. Position the servo mount plate on the servo plate base (in the center section of the wing) so the ball on the servo arm aligns with the holes in both #2 ribs (where the flap pushrod will come through). Drill 1/16" [1.60mm] holes at the punch marks in the servo mount plate through the servo plate base.

- ❑ 21. Turn the center section over. Glue strips of leftover 1/8" [3.2mm] ply to the bottom of the plate base across the holes you drilled (see the following photo). Re drill the holes in the plate base through the strips with a 1/16" [1.60mm] drill. Enlarge the holes **in the servo mount plate only** with a 3/32" [2.40mm] drill. Temporarily mount the servo mount plate to the plate base with four #2 x 3/8" [9.5mm] screws.

- ❑ 22. Remove the jig tabs from the bottom of the ribs. Sand the top sheeting and sub LE even with the ribs on both sides of the center section.

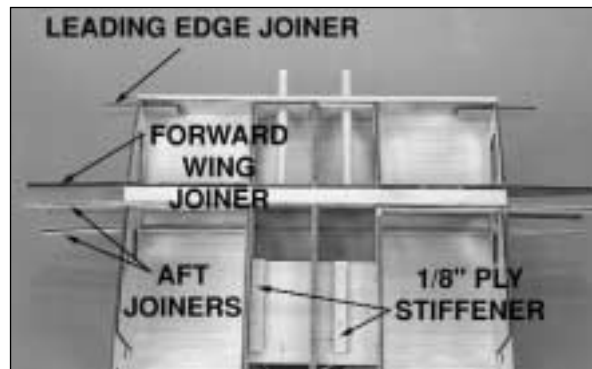

- ❑ 23. Test fit the laser-cut 1/8" [3.2mm] plywood **forward wing joiners**, **top** and **bottom aft wing joiners** and the die-cut **leading edge joiners**. Round one end of both 1/4" x 4" [6.4 x 102mm] hardwood **wing dowels** and test fit them in the sub leading edge and the aft wing dowel plates.

Note: You may have to cut a small section from the wing sheeting ahead of the top spar to install

the forward joiners. If necessary, adjust the notches in the ribs or remove excess glue so the joiners fit well.

Each of the next three steps requires 30-minute epoxy, so try to finish them all before taking a break.

- ❑ 24. Glue all the joiners **to the center section only** with 30-minute epoxy. Wipe away excess epoxy before it cures.

- ❑ 25. Glue the wing dowels in the center section with 30-minute epoxy.

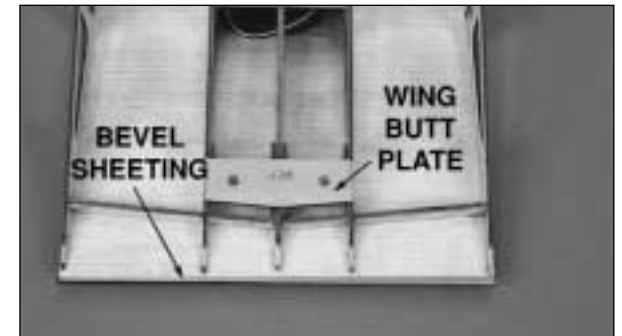

- ❑ 26. Drill a 1/4" [6.30mm] hole through both punch marks in the wing bolt plate. Use 30-minute epoxy to glue the wing bolt plate into the notches of ribs 1 and 2 in the center section.

- ❑ 27. Sand the bottom of the center section so the spars, sub LE and ribs blend. Bevel the TE of the top sheeting to accommodate the bottom sheeting.

- ❑ 28. Glue the bottom sheeting to the center section. After the glue dries, sand the edges of the sheeting even with the ribs on both ends of the center section.

Perform step 29 only if you are building flaps.

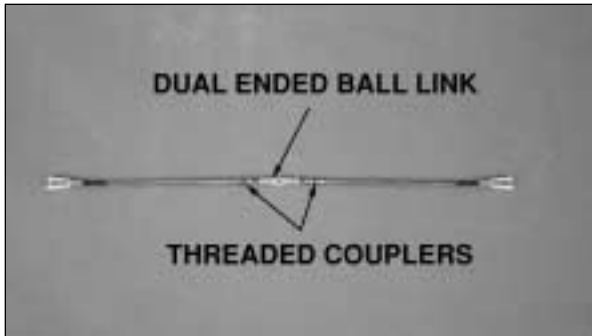

□ 29. Make the **flap center pushrod** from two 6" [152mm] rods that are threaded on one end, two threaded couplers, two nylon clevises and a dual-ended ball link. Cut the pushrods to the correct length shown on the plan and silver solder the threaded couplers to them. Wipe the pushrods with oil so the flux used with your silver solder will not cause them to rust.

JOIN THE OUTER PANELS TO THE CENTER SECTION



□ 1. Test fit the **left** wing panel to the center section. If necessary, trim the landing gear rail notches (if you are installing retracts) and the spar notches in the root rib of the left wing panel so both panels align.

□ 2. Test fit the right wing panel to the center section the same way.

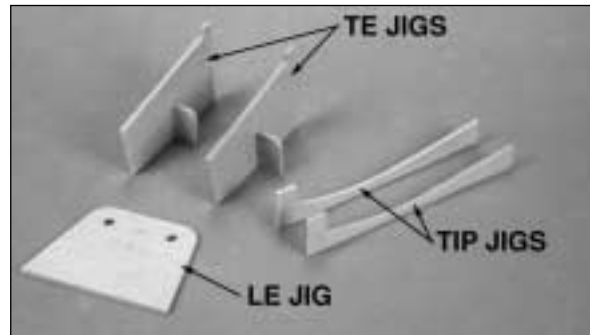

□ 3. Assemble the die-cut 1/8" [3.2mm] plywood **upside down TE jigs** and locate the die-cut 1/8" [3.2mm] plywood **upside down tip jigs** and the **upside down LE jig**.

□ 4. If you're building flaps, slide the flap center pushrod into the center section and temporarily connect it to the flap servo just to keep it in place.



□ 5. Make sure your landing gear rails are in place but not yet glued in both wing panels (if you're installing retracts). Temporarily join both outer panels to the center section and place the wing on the jigs upside down on your workbench with the tip jigs under rib 13 at each tip. Place weights over the center section and the wing tips. Make sure the panels and the center section rest on the jigs. Position the landing gear rails in the notches of the ribs as shown on the plan (if you're installing retracts). Carefully view all joining parts and make adjustments where necessary.

□ 6. Gather your clamps and cut some paper towels into 2" [50mm] squares to wipe away excess epoxy as you proceed. Separate the wing panels. Mix up a batch of 30-minute epoxy and apply to all joining surfaces. Proceed immediately to the next step.

Note: If you feel your 30-minute epoxy will not provide enough working time for you to join both wing panels, you may join one at a time.



□ 7. Join the wing panels to the center section as described in step 5 and place it on the jigs (retract installers – your landing gear rails are in position, right?). Position your clamps, wipe away excess epoxy and do not disturb the wing until the epoxy has fully cured.

□ 8. If you have not done so already, join the other panel to the center section in the same manner.

FIT THE LANDING GEAR

Perform steps 1, 2 and 3 only if you are building fixed landing gear.

1. Use 30-minute epoxy to glue a 1/2" x 3/4" x 6" [12.7 x 19.1 x 152mm] grooved basswood **fixed gear mounting rail** and a 5/8" x 3/4" x 1" [15.9 x 19.1 x 25.4mm] maple **torque block** to each other and ribs 4, 5 and 6 in both wing panels as shown on the plan (see the following photo). Use a C-clamp to hold the torque block to the ply doubler on rib 6 until the epoxy is fully cured.

(Disregard the wing sheeting in these photos.)

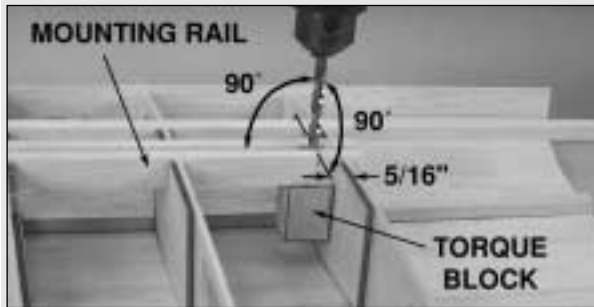

2. Mark the bottom of the mounting rails 5/16" [8mm] from the edge of the ply doubler on rib 6. Drill a 3/16" [4.70mm] hole through the landing gear rails and the torque blocks at the mark. As you drill, make sure you hold your drill at a 90 degree angle to the landing gear rail.



3. Chamfer the inside edge of the hole in the landing gear rail to accommodate the bend of the

landing gear. This will allow it to fully seat in the groove. Test fit the bent 3/16" [4.8mm] wire **landing gear** in the landing gear rail. Make adjustments where necessary for a good fit.

That's all for now for the fixed gear. Skip to *Prepare the outer panels for sheeting* on page 23.

Perform steps 4 through 13 only if you are installing retracts.

Our prototype Spitfire uses and this instruction manual shows how to install, Robart #605 Heavy Duty (3/16" [4.8mm] wire) 90-degree pneumatic retracts. Other units may work, but it is up to you to make any modifications necessary.

BEFORE

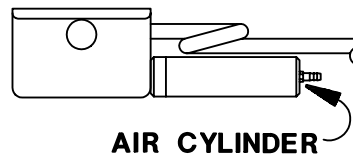

AIR CYLINDER

AFTER

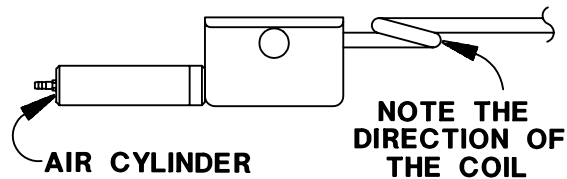

4. Disassemble your retracts and mount the air cylinder so it comes out the other end. Switch the right and left landing gear wires so the strut will be below the coil, giving the wheel more room in the wheel well.

Start with the left wing panel so your progress matches the photos.

5. For now, cut the landing gear wire to a total length of 6" [150mm] (from end to end)—this will be slightly too long but you can *fine-tune* the length later. A cut-off wheel on a rotary tool works best for cutting the landing gear wire. Don't forget your safety glasses! Bend your landing gear wires forward until they match the drawing shown on the wing plan.

6. Place your retract on the left landing gear rail in the wing. Position the landing gear wire so the *coil* is parallel with the wing ribs when the landing gear is extended (see the following photo). Tighten the set screw to lock the landing gear wire in this position.



7. Place a 3/16" [4.8mm] axle on your landing gear wire 5-3/16" [132mm] from the retract *pivot point*. Position the axle so it is parallel with the main spar and tighten the set screw to lock the axle in position.

8. Remove the die-cut piece from rib 6 to accommodate the wheel when you test fit the landing gear.

9. Cut out rib 5 as necessary to clear the landing gear wire when you retract it into the wing. Use a rotary tool and a sanding drum if you have one.

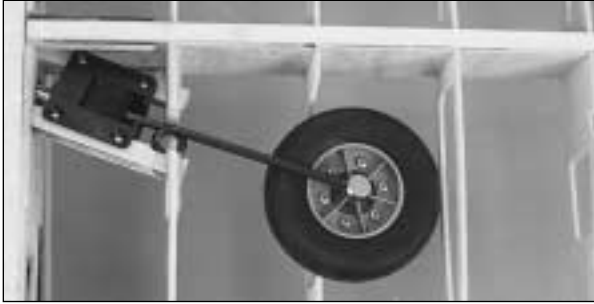

☐ 10. Temporarily mount your wheel to the axle and retract the gear into the wing. Make sure the landing gear will operate correctly and there is no interference.

☐ 11. Return to step five and fit the right retract in the right wing panel the same way.

☐ 12. Drill holes in the landing gear rails and mount your retracts with the screws included with the retracts. Make sure both retract units are in the same location on the rails.

☐ 13. Double-check the retract action and make sure the wheels and struts do not interfere with anything when you retract them into the wing. Trim where necessary.

PREPARE THE OUTER PANELS FOR SHEETING

Perform step 1 only if you are not building flaps

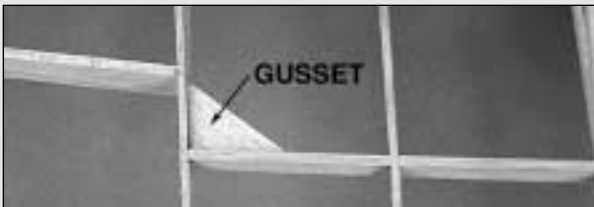

☐ 1. Use the 3/16" x 3/4" x 6" [4.8 x 19.1 x 152mm] balsa stick to make two **gussets** joining

rib 8 to the inner TE of both wing panels. Glue the gussets in position.

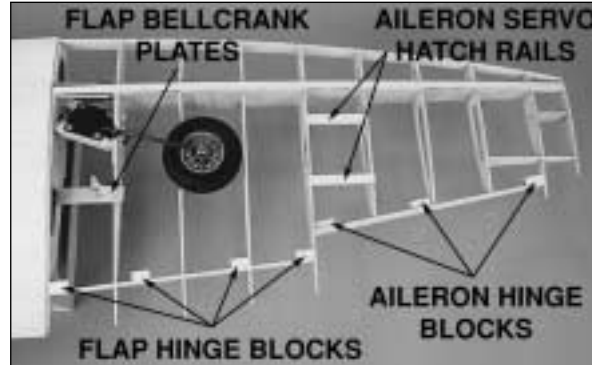

Refer to this photo for the rest of this section.

Perform steps 2 through 5 only if you are building flaps

BOTTOM OF WING (AS ON YOUR WORKBENCH NOW)

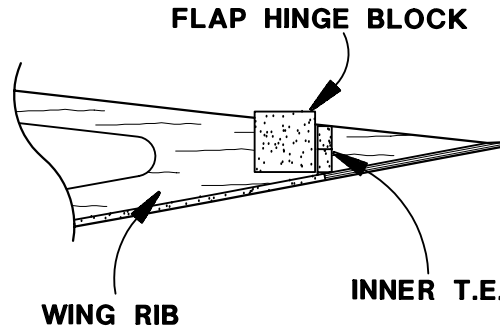

☐ 2. Cut eight 3/4" [19mm] long **flap hinge blocks** from the 3/8" x 3/8" x 12" [9.5 x 12.7 x 305mm] balsa stick. Glue the hinge blocks to the **front** of the inner TE's where shown on the plan as indicated in the sketch.

☐ 3. Trim the flap hinge blocks so they are even with the ribs and TE's.

☐ 4. Securely glue both flap bellcrank plates to ribs 4 and 5 as shown on the plan.

Note: Study the plan and position the flap bellcranks so both flap pushrods move **in the same direction** when the servo is actuated.

☐ 5. Slip a silicone retainer over both clevises of the flap center pushrod (not shown in the photo) and connect the pushrod to the bellcranks. Make sure the bellcranks are neutral when the flap servo is neutral. Adjust the clevises if necessary. Enlarge the hole of both flap bellcranks that the pushrods connect to with a #48 [1.90mm] or 5/64" drill.

☐ 6. Cut six 1" [25mm] long **aileron hinge blocks** from the same 3/8" x 3/8" [9.5 x 9.5mm] balsa stick you used for the flaps and glue them to the outer TE of both wing panels where shown on the plan. Trim the outer aileron hinge blocks so they are even with the outer TE.

☐ 7. Mark the location of the flap and aileron hinge blocks on the outside of the TE's so it will be easier to determine where to make the hinge slots later.

☐ 8. Cut four **aileron servo hatch rails** from the 1/4" x 3/8" x 24" [6.4 x 9.5 x 610mm] basswood stick. Glue the servo hatch rails into the notches of ribs 8 and 9 of both wing panels.

MAKE THE WING SKINS

☐ 1. Gather sixteen 1/16" x 3" x 30" [1.6 x 76 x 762mm] balsa sheets for the wing sheeting.

☐ 2. True the joining edges of four 1/16" x 3" x 30" [1.6 x 76 x 762mm] balsa sheets and glue them together. This is one wing skin. Repeat this process three more times.

☐ 3. After the glue dries sand the sheets flat, smooth and even.

SHEET THE BOTTOM OF THE WING

1. If you haven't done so already, remove your retracts from the wing.
2. Make sure all the ribs, spars, rails and trailing edges smoothly blend. Sand where necessary.

Sheet the left wing panel first.

3. Put your wing upside down on the upside down jigs. They make a handy platform for working on your wing in the next few steps.
4. Trim one of your wing skins to fit the left wing panel. Make sure you trim the skin slightly oversize to allow for positioning and trimming.

Perform step 5 only if you are installing fixed landing gear.

5. Position the bottom wing skin on the wing to determine where the landing gear rail contacts the skin. Cut a slot in the bottom skin to accommodate the landing gear rail. Proceed to step 8.

Perform step 6 only if you are installing retracts.



6. Use leftover 1/16" [1.6mm] balsa sheeting (you should have plenty of leftover sheeting by

now!) to make **wing skin doublers** that fit inside the wheel and retract openings in the bottom skin. The doublers fit **between** the ribs as shown in the photo. Set these pieces aside for now. You will be instructed to glue them inside the wing **after** you sheet the bottom.

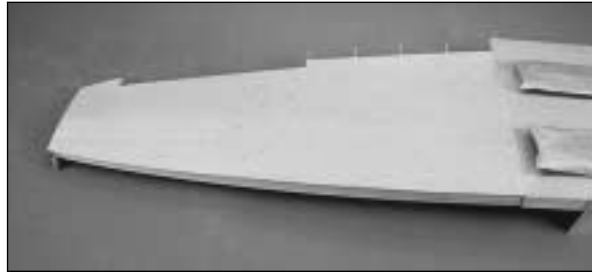

7. Glue the bottom skin in position. There are several methods to do this but one we prefer is to apply a bead of medium or thick CA along the bottom spar and rib 4. Quickly position the bottom skin on the wing and lightly press it down to the spar and rib 4.

8. After the CA on the spar and rib 4 cures, lift the skin and apply a bead of CA to the outer trailing edge and rib 13. Press the skin down over these areas.

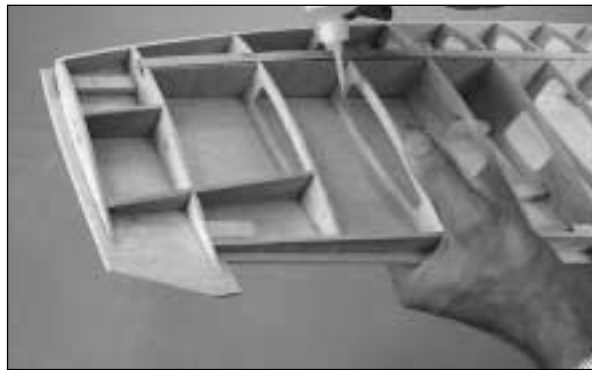

9. After the CA cures, remove the wing from the jigs and turn it upright. Carefully, holding the

wing in your hand (and without adding any twist to the wing), one rib at a time apply a light bead of medium CA to each rib and press the bottom skin to it. Glue the skin to the sub leading edge the same way. **Do not glue the skin to the inner trailing edge at this time.**

10. Trim the bottom skin along the sub leading edge, tip rib 13 and the outer trailing edge. Trim the trailing edge of the skin between ribs 12 and 13 at least 1/8" [3mm] past where shown on the plan (to allow for trimming later).

Perform steps 11, 12 and 13 only if you are installing retracts.



11. Working quickly, apply thick or medium CA to the inside of the bottom skin in the area of one of the bottom skin doublers. Slip the doubler into place and press it to the bottom skin. Glue the other two bottom skin doublers in place the same way.

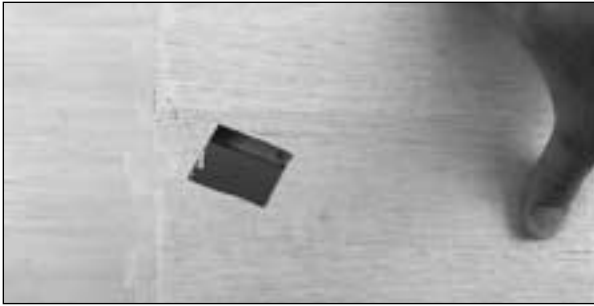

12. Cut the bottom skin to accommodate the landing gear. First, cut a small hole under the retract rails for just the retract (not the wheel and strut). Enlarge the hole little by little, test fitting the retract as you proceed, until you can install the retract.

Note: The hole will be slightly *offset* due to the angle at which the rails rest in the wing and the extra clearance required to install the retracts.



13. Cut the bottom sheeting until you can retract the strut and the wheel into the wing. The hole in the wing sheeting for the wheel will not be a

circle but will be more of an *ellipse* because of the angle at which the wheel retracts into the wing. Allow at least 1/8" [4mm] clearance between the wheel and the rear of the opening in the wing in case you bend your landing gear on one of those bumpy landings.

14. Return to step 3 and construct the right wing panel.

Note: If you wish to install the 1/8" [3.2mm] plywood **wheel covers**, now is the time to fit those parts. A template is provided on the plan sheet and a close-up photo and instructions on how to install the wheel covers are on page 55. If you wish to install fully scale, operational gear doors, it is up to you to build and fit the doors yourself. Study sketches and photos in the scale documentation data you have collected to find out how the doors should look and operate. In either case, you should have the **radiators** handy in case you have to slightly decrease their size or change their location to accommodate the wheel covers or scale doors. Skip ahead to page 32 to build the radiators.

PREPARE THE TOP OF THE WING FOR SHEETING

1. Cut an opening in the bottom of the left wing panel for the die-cut 1/16" [1.6mm] plywood **aileron servo hatch**. Start by cutting the approximate size of the hatch and carefully enlarge the opening using a fresh #11 blade and a straightedge until the hatch fits (you can see the hatch in the photo at step 3).

Hint: As you *zero-in* on the final shape of the hatch opening, use the hatch itself as a template to cut the hatch.

2. Place the hatch on the rails, making sure it is in the correct orientation as shown on the plan. Drill 1/16" [1.60mm] holes through the punch marks in the hatch into the rails.

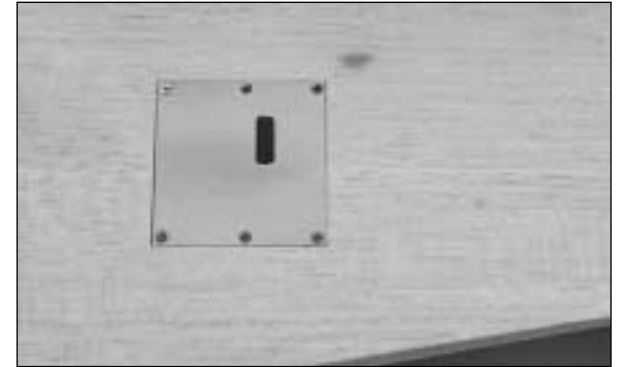

3. Enlarge the holes **in the hatch only** with a 3/32" [2.40mm] drill bit. *Countersink* the holes for the #2 x 3/8" [9.5mm] flat head screws with a countersink or other pointed tool. Test fit the hatch to the rails with the screws. If necessary, sand the edges of the hatch so it aligns with the edges of the hatch opening.

Note: If you find it difficult to countersink the holes in the hatch for the flat head screws, you could use regular #2 x 3/8" [9.5mm] screws (not supplied) without countersinking the holes.

4. Mount your servos to two 5/16" x 3/4" x 7/8" [7.9 x 19.1 x 22.2mm] **servo mount blocks** with the screws included with your servo.

5. Mark the edge of the hatch rails on the inside of the hatch.

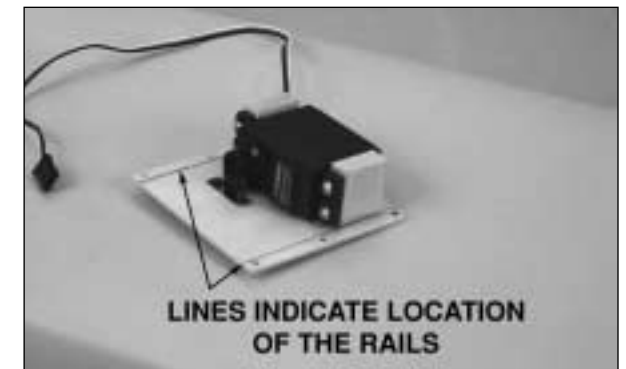

6. Remove the hatch and use 30-minute epoxy to glue the servo mount blocks to the servo

hatch where shown on the plan. Position the servo within the lines you marked inside the hatch indicating where the rails are.

7. Temporarily mount the hatch with your aileron servo in the wing.

8. Return to step 1 and mount the hatch and aileron servo on the right wing panel.

Perform steps 9 through 13 only if you are building flaps.

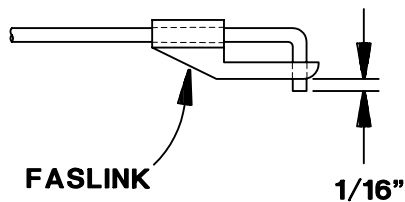

9. Make a **flap pushrod** by threading a nylon clevis onto a .074" x 6" [1.9 x 152mm] pushrod about 20 turns. Make a 90 degree bend in the pushrod where it crosses the flap bellcrank to match the plan. Temporarily snap a nylon **Faslink** onto the pushrod. Cut the excess pushrod so 1/16" [1mm] protrudes from the Faslink. Connect the clevis to the outer hole of a small nylon control horn. Make another flap pushrod the same way.



10. Cut the *exit holes* in the bottom wing skin for both flap pushrods where shown on the plan.

Temporarily position a bottom flap skin in its location on the wing. Temporarily connect the flap pushrods to the bellcranks and rest the flap horn on the flap. Make sure the exit holes are large enough and in the correct location to allow the pushrods to pass through the bottom wing skin. Make adjustments if necessary.

11. Remove the flap pushrods but keep them nearby.

12. Sand the bottom of the wing around the flap pushrod exits. This will be difficult to do after you connect the pushrods because they may be in your way.

13. Connect the flap pushrods to the bellcranks with the Faslinks.

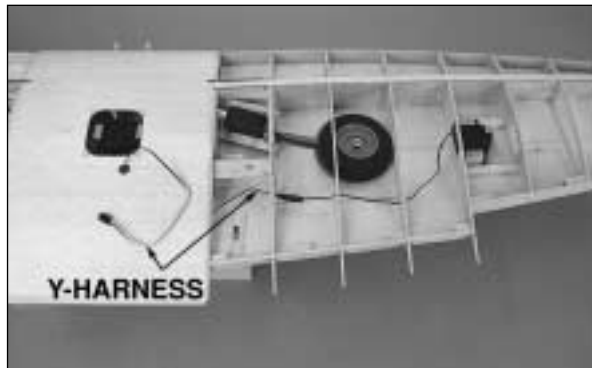

14. Install your aileron servo wires and a Y-harness in the wing. We used a Hobbico® Command™ Y-harness (HCAM2500). Cut a hole in the top sheeting of the center section to allow the connector to exit. Make sure you will be able to remove the servos and disconnect them from the Y-harness from outside the wing after it is fully sheeted. You should be able to access the connectors through the wheel wells. If you're not installing retracts, you may need a longer Y-harness.

Perform step 15 only if you are installing retracts.



15. Move your servo cords out of the way and coat the inside of the wing around the wheel wells and landing gear cutout with fuel proof paint. We mixed K&B blue and yellow paint to simulate the green Zinc Chromate coating aluminum airplanes receive (refer to the Expert Tip in the *Painting* section on page 51 for more hints on painting).

Hint: Save the leftover paint you just mixed to coat the inside of the top sheeting later on.

16. Sand the tops of the ribs, spars, leading edge and trailing edge so they smoothly blend.

17. Inspect the wing and reinforce any glue joints that don't look strong.

18. Sand the trailing edge of the bottom sheeting at the tip to accommodate the top sheeting.

SHEET THE TOP OF THE WING

❑ 1. If you haven't already done so, make the top wing skins as described in steps 1, 2 and 3 on page 23.

Sheet the left side of the wing first.

❑ ❑ 2. Trim the end of one of the skins to join the top sheeting of the center section (the skin will have a slight *curve* due to the curvature of the airfoil and the dihedral of the wing). When the skin accurately fits the center section, trim it about 1/4" [6mm] larger than the outline of the rest of the wing to allow for positioning errors and trimming later.

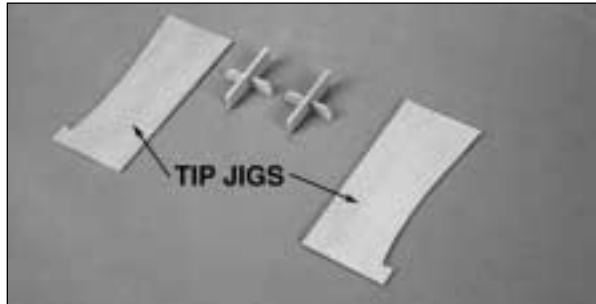

❑ ❑ 3. Build the die-cut 1/8" [3.2mm] plywood **upright wing jigs**. Place the wing on the jigs and place weights over the center section to hold it down. Place the tip jigs under the wing tips.



❑ ❑ 4. Use a piece of leftover balsa or something similar to support the trailing edge of the wing near

the tip of the flap. This will keep the wing from *bowing* when you place weights on it to hold the top skin down.



❑ ❑ 5. Apply aliphatic resin to the top spar, outer trailing edge and all the ribs **except** tip rib 13. **Do not** apply glue to the inner trailing edge, tip rib 13 or the sub leading edge. Position the wing skin and use weights and T-pins to hold it down.

❑ ❑ 6. Glue the front of the sheeting to the sub leading edge and the tip of the sheeting to rib 13 with medium CA. Do not disturb the wing until the glue is fully dried.

Note: The top sheeting tends to *buckle* near the wing tip because it is trying to bend in two directions at the same time (toward the tip and toward the leading edge). Place plenty of weights over the sheeting near the tip to prevent or minimize this tendency. This is also why we recommend you glue the sheeting to tip rib 13 with CA—because you can hold it down with your hand momentarily until the CA cures.

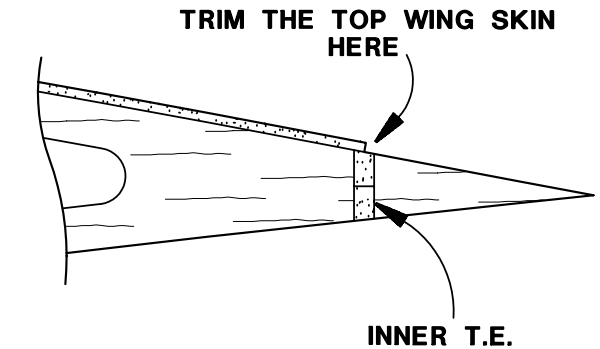

❑ ❑ 7. Remove the weights and T-pins. Trim the top skin even with the sub leading edge, tip rib 13 and the outer trailing edge. Use a straightedge to trim the skin to the **center** of the inner trailing edge.

❑ 8. Return to step 2 and sheet the right side of the wing the same way.

❑ 9. Coat the top sheeting inside the wheel wells with fuel proof paint the same way you did to the bottom sheeting.

BUILD THE FLAPS

Perform steps 1 through 4 only if you are not building flaps.

❑ 1. Use one of the die-cut 1/16" [1.6mm] plywood **flap skins** as a *template* to make four balsa **flap skins** from leftover 1/16" [1.6mm] balsa.

❑ 2. Test fit the flap skins to the wing and trim where needed for a good fit. Bevel the trailing edge of the flap skins as shown in the sketch below.

❑ 3. Glue the balsa flap skins to your wing.

❑ 4. Proceed to *Build the ailerons* on page 30.

Perform steps 5 through 26 only if you are building flaps.

Make the left flap first.

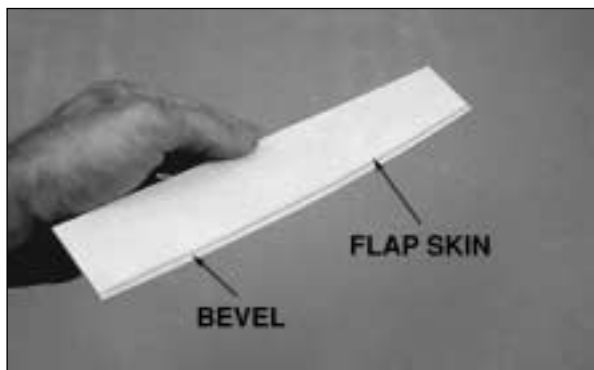
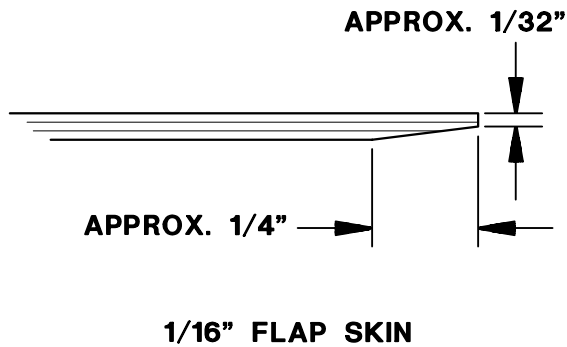

❑ 5. Test fit a die-cut 1/16" [1.6mm] plywood **flap skin** on top of the wing. Trim the ends and the leading edge of the flap skin if necessary for a good fit. Bevel the trailing edge of the **bottom** of the flap skin as shown in the sketch and the photo.

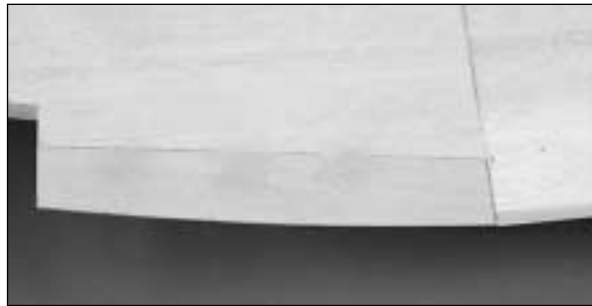

❑ 6. Glue the flap skin to the top of the wing.

❑ 7. Trim the bottom flap skin so it aligns with the top flap skin when you position it on the wing.

❑ 8. Bevel the top of the bottom flap skin the same way you beveled the bottom of the top flap skin.

In order for your flaps to operate correctly and have the best fit and appearance, the holes for the hinges in the wing and in the flap (and therefore the hinges themselves) must: **1) be perpendicular** to the flap LE and inner TE and **2) accurately align** with each other. Follow the instructions closely and work as accurately as you can to achieve this.



❑ 9. Use a square to mark the centerlines of the hinges across the bottom of the flap skin where shown on the plan.

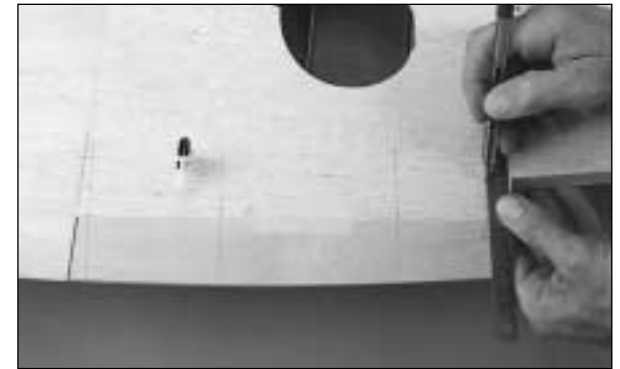

❑ 10. Tape the flap skin to the wing. Use a straightedge to extend the hinge centerlines from the flap to the wing. These lines will help you keep your drill perpendicular as you drill the holes for the hinges.

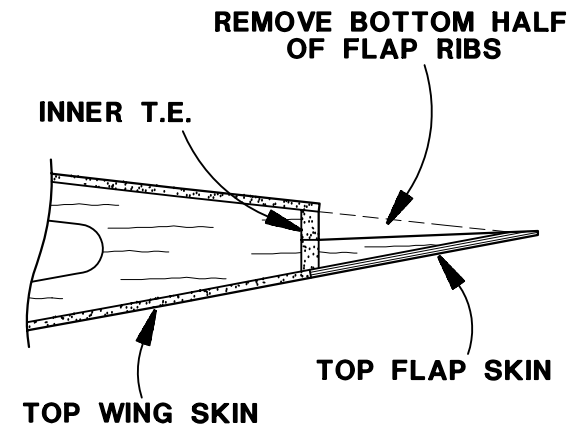

❑ 11. Remove the bottom flap skin and cut the bottom half of the ribs along the lines you marked earlier. Remove the bottom portion of the ribs (see the following photo).

BOTTOM OF WING

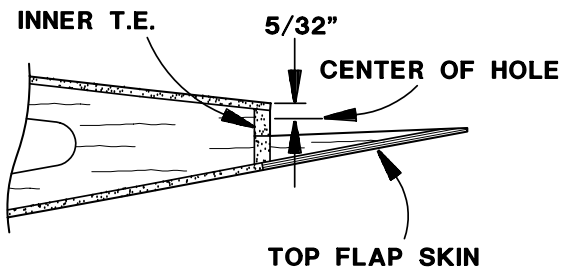

TOP OF WING

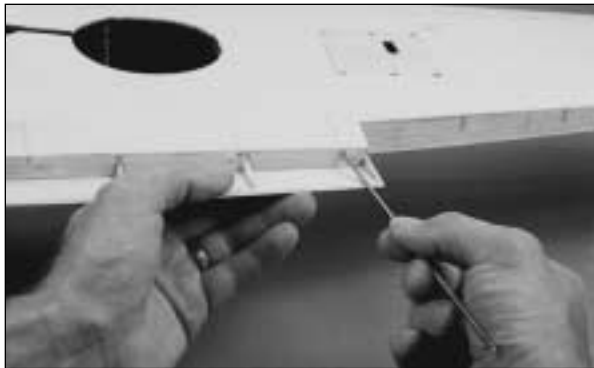

□ □ 12. Refer to the sketch above and drill $3/32$ " [2.40mm] holes in the inner TE for the hinges, **keeping your drill aligned with the guidelines** on the bottom of the wing (a $3/32$ " [2.40mm] drill bit in a high speed rotary tool works the best). The center of the holes should be $5/32$ " [4mm] above the bottom sheeting as shown in the sketch.

Hint: Start the holes with a $3/32$ " [2.4mm] brass tube sharpened at the end. This will increase your accuracy by keeping your drill from wandering off center.

□ □ 13. Slightly enlarge the front of the holes so the hinge points can be inset as shown on the plan. Use a *cutting burr* in a rotary tool for this if you have one. Test fit the hinge points to make sure they fit.

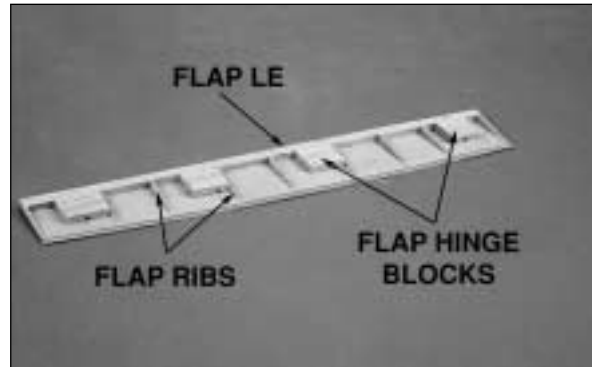

Refer to this photo for steps 14 through 18.

□ □ 14. Cut the **flap LE** from a $3/16$ " x $1/4$ " x 24" [4.8 x 6.4 x 610mm] balsa stick. Glue the flap LE to the top of the bottom flap skin.

□ □ 15. Remove the hinges from the wing and trim the flap LE until the flap fits the wing.

□ □ 16. Cut the **flap ribs** from a $3/32$ " x $3/8$ " x 24" [2.4 x 9.5 x 610mm] balsa stick. Glue the flap ribs to the flap where shown on the plan and sand them to match the shape shown on the cross section.

□ □ 17. Cut the **flap hinge blocks** from the $3/16$ " x $3/4$ " x 12" [4.8 x 19.1 x 305mm] balsa stick and glue them to the flap where shown on the plan.

□ □ 18. Use the guidelines on the flap skin to drill $3/32$ " [2.40mm] holes for the hinges. The same as the holes in the wing trailing edge, the center of the holes for the hinges in the flaps should be $5/32$ " [4mm] above the bottom edge of the flap skin. Enlarge the front of the holes so the hinges will fit as shown on the plan.

□ □ 19. Sand the hinge blocks so they match the flap ribs and so the flap fits the wing.

□ □ 20. Round the leading edge of the flap as shown on the plan and cut a small notch at each hinge to allow the flap to fully travel without interfering with the hinges.



□ □ 21. Test fit the flap to the wing with the hinges. Raise the flap. Enlarge the notches in the flap for the hinges or make other adjustments if necessary.

□ □ 22. Cut the **flap control horn block** from the $3/16$ " x $3/4$ " [4.8 x 19.1mm] balsa stick and glue it inside the flap where shown on the plan. Use the flap horn as a *template* to drill two $1/16$ " [1.60mm] holes through the flap for the #2 x $3/8$ " [9.5mm] screws.



□ □ 23. Reinforce the screw holes with a few drops of thin CA. After the CA dries, temporarily mount the flap control horn to the flap with the screws.

□ □ 24. Cut the screws if they interfere with the top flap skin or ribs when the flap is raised.

□ □ 25. Move the flap through its range of motion. Make adjustments where necessary.

□ □ 26. Return to step 1 and build the other flap the same way.

BUILD THE AILERONS

- ☐ ☐ 1. *True up* the wing sheeting where the ailerons will fit.

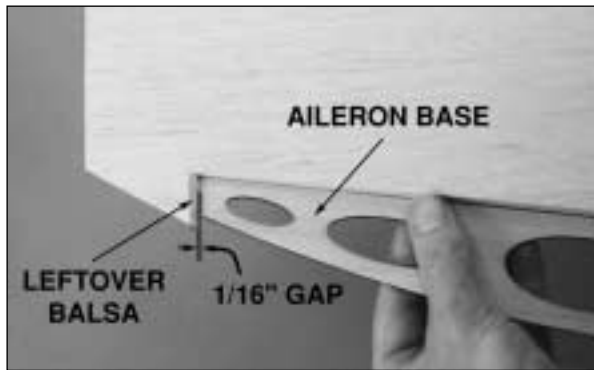

- ☐ ☐ 2. Hold a die-cut 3/32" [2.4mm] balsa **aileron base** up to the wing. Glue a piece of leftover balsa to the wing so the gap between the end of the aileron and the wing will be approximately 1/16" [2mm] wide. Our model required a piece of 1/8" [3.2mm] balsa. Sand the balsa even with the wing sheeting.

- ☐ ☐ 3. Cut the **aileron leading edge** from the 1/4" x 7/8" x 24" [6.4 x 22.2 x 610mm] balsa stick. Trim the aileron leading edge so it fits in the wing against the outer TE.



- ☐ ☐ 4. Pin the aileron leading edge to the wing, then shape it so it matches the wing sheeting on the top and the bottom.

- ☐ ☐ 5. Use the plan to mark the location of the aileron ribs on both sides of the aileron base.

For the next two steps it is helpful to set the wing on the leading edge between two blocks or boxes so it won't fall over.



- ☐ ☐ 6. Glue the aileron base to the aileron LE. Make sure the front of the aileron base is centered on the aileron leading edge and the trailing edge of the aileron base aligns with the flap and wing tip. You may have to relocate your T-pins so they do not interfere with the aileron base.

- ☐ ☐ 7. Cut the top and bottom **aileron ribs** from two 3/32" x 3/8" x 24" [2.4 x 9.5 x 610mm] balsa sticks. Glue the ribs to the aileron base and the aileron LE, making sure you keep the aileron base aligned with the wing.

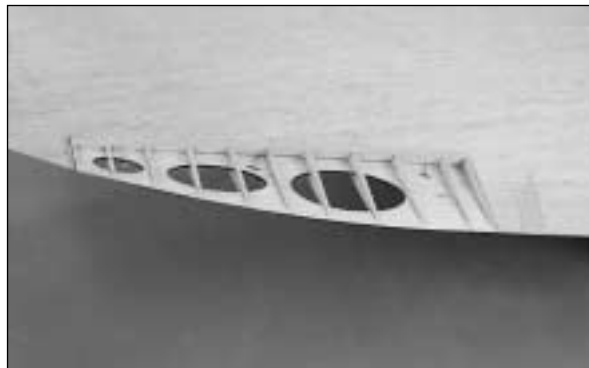

- ☐ ☐ 8. Use your razor plane or a bar sander to trim the ribs to the shape of the wing and aileron.

- ☐ ☐ 9. Remove the T-pins and take the aileron out of the wing.

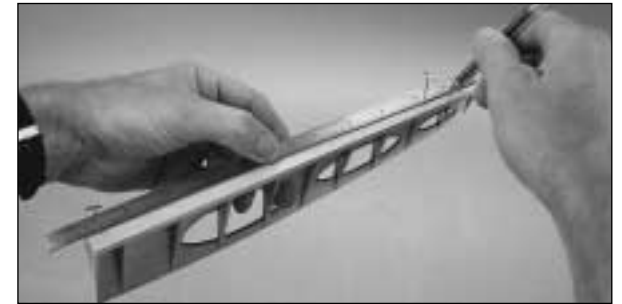

- ☐ ☐ 10. Place a straightedge against two T-pins in the **center** of the aileron LE near both ends. Use a ballpoint pen to mark the centerline of the aileron LE along the straightedge.

- ☐ ☐ 11. Mark the centerline of the inner TE of the wing the same way.

- ☐ ☐ 12. Glue pieces of leftover 3/32" [2.4mm] balsa to the aileron base over the location of the hinge slots. You can see these pieces in the next photo. Cut the hinge slots along the centerlines of the wing and the aileron where shown on the plan.

- ☐ ☐ 13. Test fit the aileron to the wing with three hinges.



- ☐ ☐ 14. Use your razor plane or a bar sander to shape the leading edge of the aileron to a "V" for control movement. Test fit the aileron to the wing. Make sure it can pivot to the recommended throws or make adjustments where needed.

- ❑ 15. Return to step 1 and build the other aileron the same way.

Let's finish up the woodwork on the wing before we hook up the ailerons and move on to the fuselage.

FINISH THE WING

- ❑ 1. If you haven't already done so, sand the top and bottom sheeting of the wing even with the sub leading edge.



- ❑ 2. Glue the center leading edge to the center section with thick or medium CA. You have already drilled holes in it so it will slip over the dowels. Hold the center section in position until the CA cures. Trim the ends even with the center section.



- ❑ 3. Glue both shaped balsa **leading edges** to the sub leading edge of both wing panels. Make sure they are centered on the front of the wing. You could use CA, but you may need a little

working time to align the LE as you bend it to the wing; therefore, we recommend using aliphatic resin and masking tape to hold it in place until the glue dries.

While you're waiting for the glue to dry on the leading edges, you can get started on the wing tips.

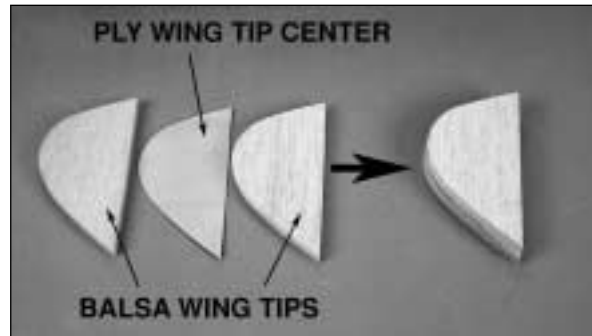

- ❑ 4. Glue the die-cut 1/32" [0.8mm] plywood **wing tip core** between two shaped 1/2" [12.7mm] balsa **wing tips**. Make another wing tip with the same parts.

- ❑ 5. *True up* both ends of the wing and the end of the wing tips where the two will join.

- ❑ 6. After the glue that holds the leading edges to the wing is dry, remove the masking tape. Use a razor plane or a bar sander to blend the leading edges to the wing and shape them as shown in the cross sections on the plan.



- ❑ 7. Glue a wing tip to the left wing. Be sure to align the 3/32" [2.4mm] ply wing tip core with the trailing edge and the center of the leading edge.



- ❑ 8. Use your razor plane or a bar sander to sand the tip to match the shape of the wing. Do not round the wing tip until the next step.



- ❑ 9. Round the wing tip as shown in the photo and the profile drawn on the plan.

- ❑ 10. Glue the other wing tip to the wing and shape it the same way.

Let's wrap this thing up. Just a few more steps and your wing will be finished!

Finish both ailerons and make the control rods at the same time even though the photos show only one side.

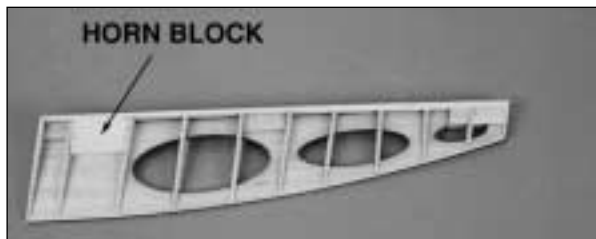

11. Glue a die-cut 1/4" [6.4mm] balsa **horn block** to the bottom of the left aileron where shown on the plan. Sand the horn block to match the shape of the aileron.

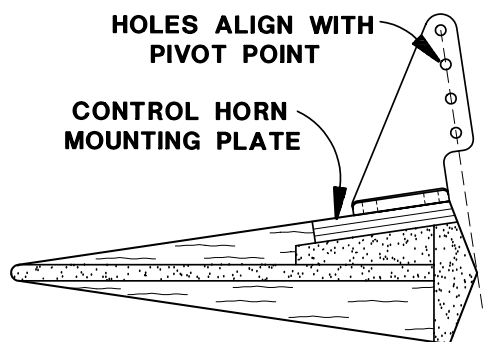

12. *Notch* the aileron and glue the die-cut 1/8" [3.2mm] plywood **control horn mounting plate** in place. Sand the mounting plate to match the shape of the aileron LE.



13. Reinstall the aileron on the wing. Make the **aileron pushrod** from a .074" x 4" [1.9 x 102mm] pushrod, a solder clevis and a nylon

clevis. Connect one end of the pushrod to the aileron servo arm and the other end to a large nylon control horn. Adjust the length of the pushrod as shown on the plan. Drill 1/16" [1.60mm] holes in the mounting plate for the control horn. Add a few drops of thin CA to the holes. After the CA dries, temporarily mount the horns to the aileron with two #2 x 3/8" [9.5mm] screws.

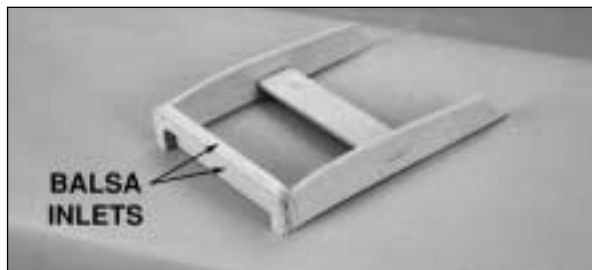

14. Build the *framework* for both **radiators** from the die-cut 1/8" [3.2mm] plywood parts. Glue two die-cut 1/8" [3.2mm] balsa *inlets* to the front of both radiators.



15. Sheet the bottom of the radiators using the 1/8" x 3" x 24" [3.2 x 76 x 610mm] balsa sheet. Round the edges as shown on the plan and in the photo.

16. You could glue the radiators to the wing after you final sand the wing but we recommend gluing them in place *after* you cover (or paint) the model.

Now does it look like a Spitfire wing? A beautiful elliptical shape, isn't it? Clean off your workbench, vacuum the floor and get out the fuse plan.

BUILD THE FUSELAGE

FRAME THE FUSELAGE TOP

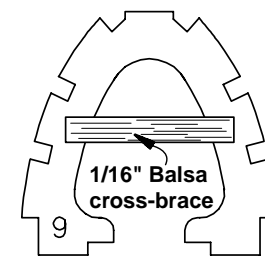

Note: We have tried to prevent the Spitfire from becoming tail-heavy by including balsa fuselage formers. These are quite fragile, however; so if you are a heavy-handed "power builder," you may wish to pre-install some 1/16" cross-braces as shown here.

1. Unroll the fuselage plan, then roll it the other way so it will lie flat. Arrange the fuse plan so the top view is over your building board or cut the top view from the rest of the plan and place it over your building board. Cover the plan with wax paper.

2. Drill 3/16" [4.70mm] holes through the die-cut 1/8" [3.2mm] balsa **formers 10, 8B and 7B** at the *punch marks* (or use a 3/16" [4.8mm] brass tube sharpened at the end to cut the holes). Press down on each former over a piece of leftover wood as you drill the holes so the wood does not split as the drill bit goes through.

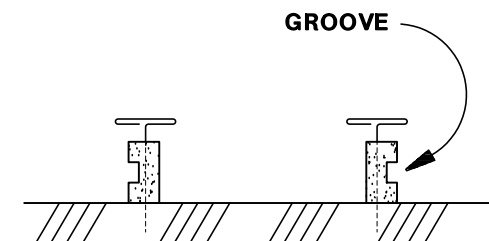

3. Cut the grooved balsa **main stringers** to a length approximately 1/8" [3mm] longer than shown on the plan. Pin the main stringers over their locations on the plan, aligning the front of the main stringers with the plan (and allowing the rear to extend past the aft end of the plan). Make sure you position the T-pins as shown in the sketch so they do not interfere with the groove in the stringer.

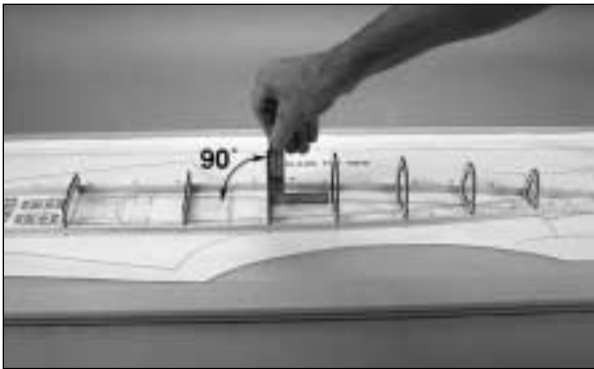

4. Starting at the rear with former 10, glue the die-cut and laser-cut 1/8" [3.2mm] balsa **formers 6** through **10** and the die-cut 1/8" [3.2mm] plywood formers **3** and **4** between the main stringers where shown on the plan. Use a small square to hold the formers perpendicular to the building board as you glue them.

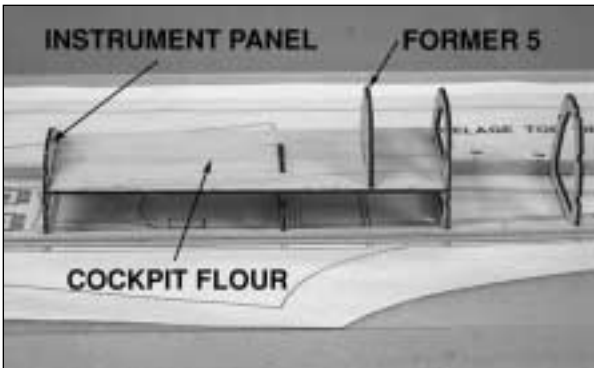

5. Add the die-cut 3/32" [2.4mm] balsa **cockpit floor**, the die-cut 1/8" [3.2mm] plywood **instrument panel** and former **5**, making sure they are perpendicular to the cockpit floor as you glue them.

Note: The partially die-cut lines on the cockpit floor indicate where to remove that portion of the cockpit floor to accommodate the scale Top Flite Spitfire Cockpit Interior kit. Do not remove that part of the cockpit floor until instructed to do so.

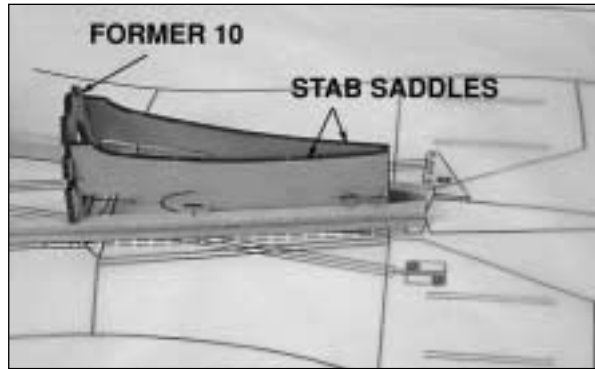

STAB SADDLES TILT TOWARDS EACH OTHER AT TOP

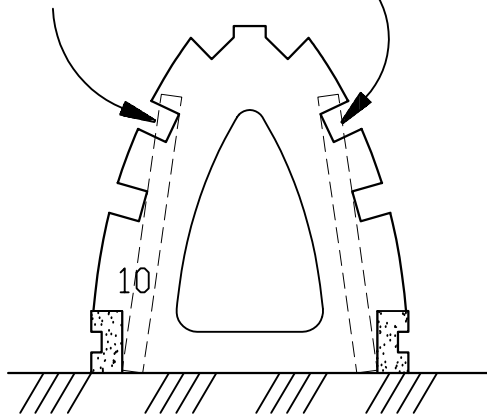

6. Glue the die-cut 1/8" [3.2mm] plywood **tail wedge** between the main stringers where shown near the aft end of the fuse plan. Glue both die-cut 1/8" [3.2mm] plywood **stab saddles** to the main stringers, the tail wedge and former 10 as shown in the sketch.

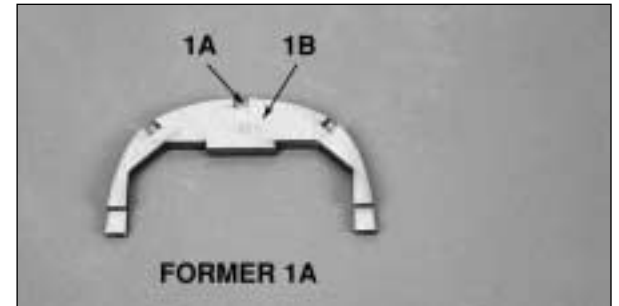

7. Glue the die-cut 1/8" [3.2mm] plywood **former 1B** to the back of **1A**. From now on this assembly will be referred to as **former 1A**.

8. Glue former 1A to the front of the main stringers, using a square to keep it perpendicular to your building board (you can see 1A in the following photo).

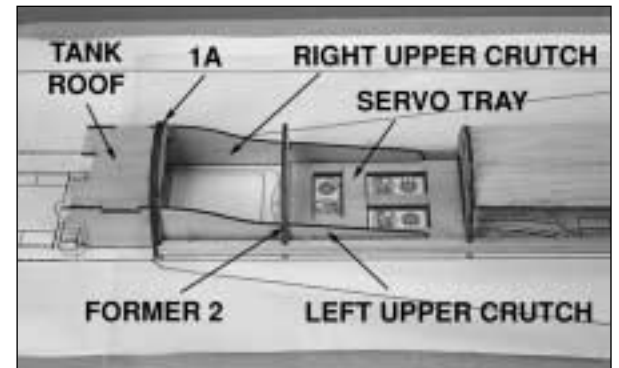

9. Join the die-cut 1/8" [3.2mm] plywood **right upper crutch (RUC)**, **left upper crutch (LUC)**, **servo tray**, **former 2** and the **tank roof (TR)**. Hold the parts in alignment and glue them together.

Note: Until you join the bottom crutches to the assembly, the right and left upper crutches *float* between the main stringers, except where they are glued to former 1A and former 2.

10. See the following sketch and trim the sides of the cockpit floor to match the contour of the instrument panel, former 5 and former 6.

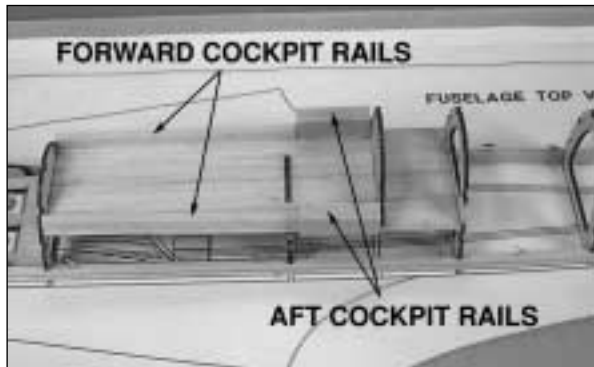
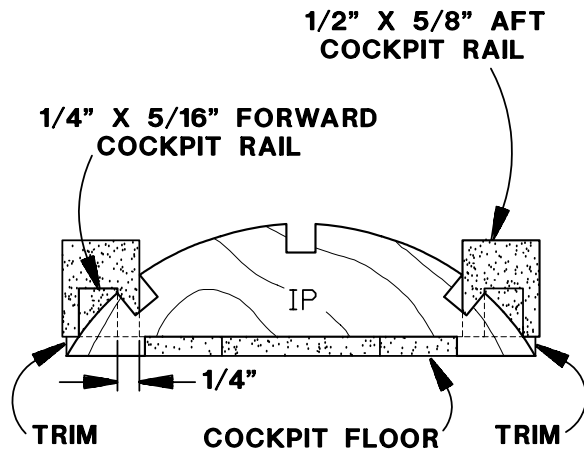

11. Cut the 1/4" x 5/16" x 15" [6.4 x 7.9 x 381mm] **forward cockpit rails** and the 1/2" x 5/8" x 6" [12.7 x 15.9 x 152mm] **aft cockpit rails** to the length shown on the plan and glue them to the cockpit floor and formers. The aft cockpit rails are *inset* 1/4" [6.4mm] inside the forward cockpit rails.

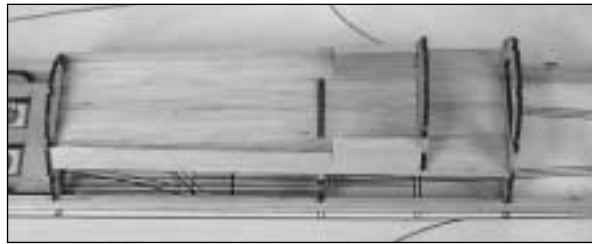

12. Trim the rails to match the contour of the formers the same way you did the cockpit floor.

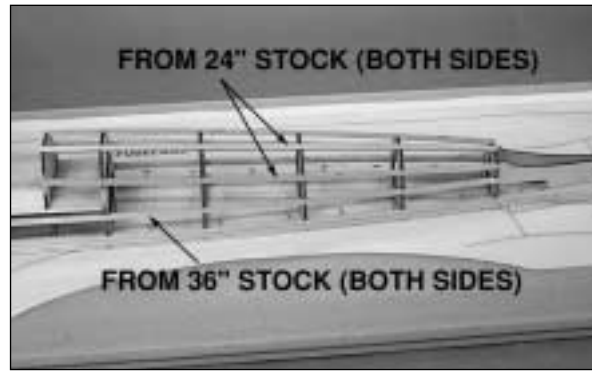

13. From two 3/16" x 3/16" x 36" [4.8 x 4.8 x 914mm] balsa sticks, cut the stringers that fit in the notches of the formers immediately above the main stringers on both sides of the fuselage and glue them in place. These stringers extend from F2 to F10. Cut the remaining four stringers that fit between formers 5 through 10 from four 3/16" x 3/16" x 24" [4.8 x 4.8 x 610mm] balsa sticks.

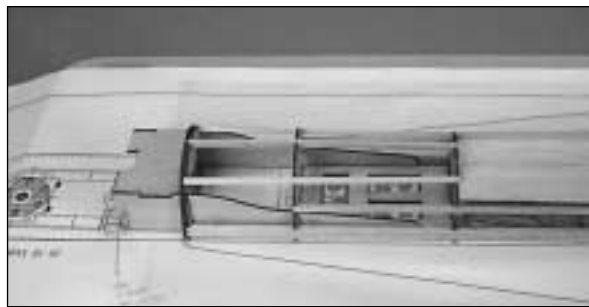

14. Use the leftover balsa sticks from step 13 to make the three forward stringers and glue them in place.

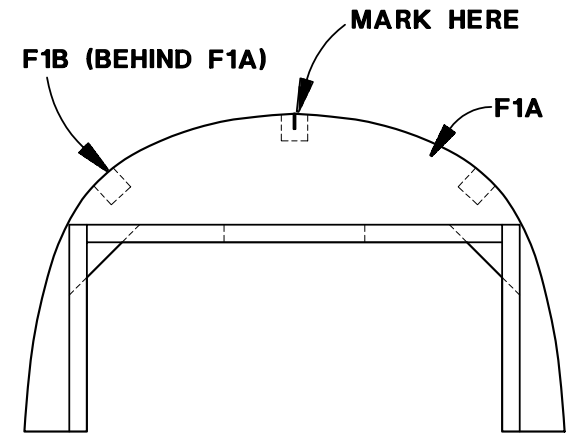

15. Use a ballpoint pen to mark the center of the middle stringer on the front of former 1A. This is a reference mark that will be used later to align the stab.

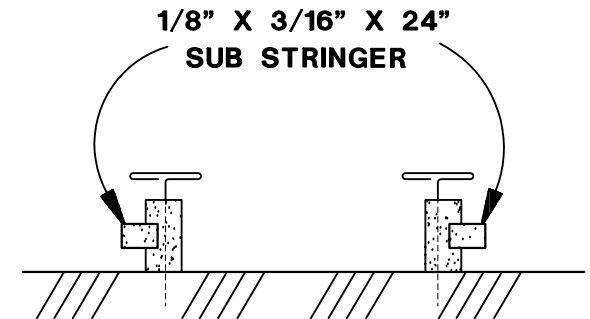

16. Glue the 1/8" x 3/16" x 24" [3.2 x 4.8 x 610mm] **fuse sub stringers** into the groove of both main stringers. The easiest way to do this is first to insert one of the stringers into the groove and make sure it is fully seated. Then, apply thin CA from the outside. Position and glue the other fuse sub stringers the same way. You can glue the bottom after you take the fuse off your building board.

SHEET THE TOP OF THE FUSELAGE

- ❑ 1. Blend the the stringers to the formers with a small bar sander and 150-grit sandpaper.



Refer to this photo for steps 2 through 8.

- ❑ 2. Use the **upper fuse skin pattern** on the plan to make the **upper fuse skin** for the left side of the fuse from a 3/32" x 3" x 36" [2.4 x 76 x 914mm] balsa sheet. Do not glue it in place until instructed to do so. Use leftover 3/32" [2.4mm] balsa to make the sheet **wide enough** to extend to the center of the top middle stringer in the front of the fuse and **long enough** to extend 5/8" [15.9mm] past the plywood stab saddles in the back of the fuse.

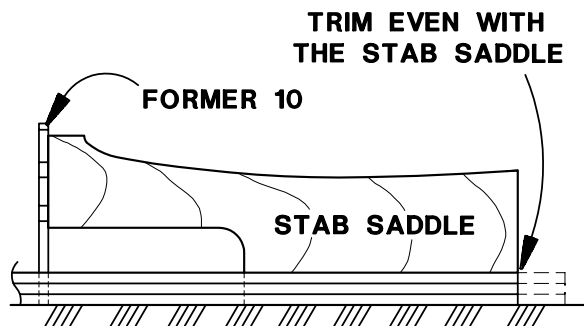

- ❑ 3. Trim the main stringer and sub stringers even with the end of the stab saddles.

- ❑ 4. Wet the outside of the upper fuse skin with isopropyl alcohol so you can carefully bend it into position as you trim it to fit your model (the pattern on the plan is slightly oversize so you will have to *custom fit* the skin to your model). Frequently wet the sheet as you continue to shape and fit it to the fuselage. By the time you are ready to glue the skin to the fuse, you will be able to bend it all the way down to the formers.

- ❑ 5. After you are satisfied with the way the left skin fits the fuse, trace its outline onto another 3/32" x 3" x 36" [2.4 x 76 x 914mm] balsa sheet. This way you will have a good starting point when you make the right skin.

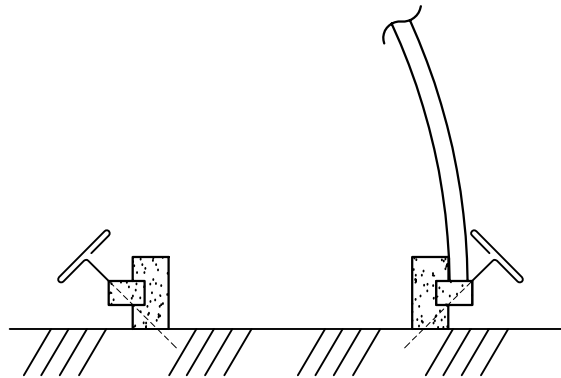

- ❑ 6. One at a time, remove the T-pins that hold the left main stringer to your building board and replace them as shown in the sketch so they will not interfere with the sheeting when you glue it in place.

Read the note at the end of step 7 before you proceed (*you're reading each step completely through to the end before you proceed anyway, right?*).

- ❑ 7. Glue the left fuse sheet in position. The best way to do this is one section at a time. First, apply a bead of medium or thick CA to the main stringer and sub stringer (see the photo at step 2) from former 5 to about 3" [75mm] from the aft end. Position the skin and hold it in place until the CA hardens. Second, glue the other half of the skin to the main and sub stringer from *inside* the fuse with thin CA. Lastly, glue the sheet to the rest of the stringers and formers with medium CA.

Note: Do not glue the fuse sheeting to the stab saddle. **Do not** glue the aft three inches of the fuse sheeting to the side and sub stringers.

- ❑ 8. Use the pattern you traced onto the other 3/32" [2.4mm] balsa sheet to make the skin for the right side of the fuse. Fit and glue it to the fuse the same way you did the left side (refer to the following photo). Don't forget to **reposition the T-pins** in the right main stringer before you glue the sheet in place.

- ❑ 9. Use another 3/32" x 3" x 36" [2.4 x 76 x 914mm] balsa sheet to sheet both sides of the turtledeck. *Sorry, no patterns for this one. You'll have to rely upon pure skill!*



- ❑ 10. Sand the top edges of the turtledeck sheets even with the top stringers and the tops of the formers.

MOUNT THE FIN AND STAB

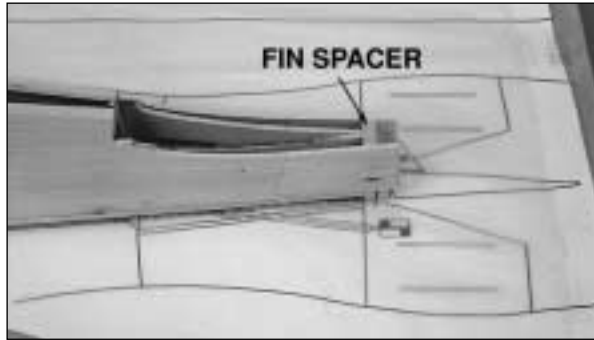

❑ 1. Slightly bevel the edges of the die-cut 1/4" [6.4mm] balsa **fin spacer** to match the tapering angle of the fuse sheeting. Glue the fin spacer to the stab saddles, accurately aligned over its location on the plan between the fuse sheeting.

❑ 2. Pin, but do not glue, the sheeting to the fin spacer.

❑ 3. Carefully sand the balsa fuse side sheeting so it is the same shape as the stab saddles. Do this without sanding the stab saddles (and inadvertently changing the incidence of the stab).

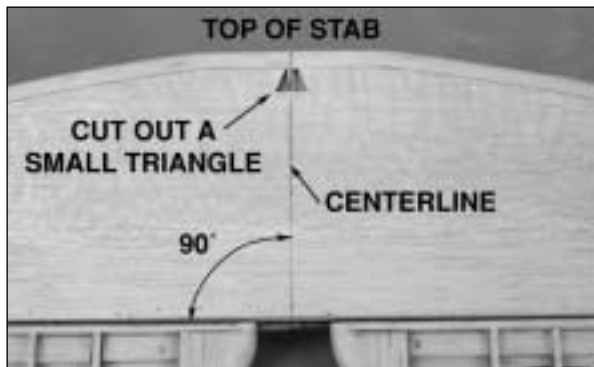

❑ 4. Cut a small piece of sheeting from the top of the stab to accommodate the leading edge of the fin. This piece doesn't have to be perfect. It just has to allow the stab LE to go through the sheeting and fit over the center rib. Use a 90-degree triangle to draw a centerline on the top of the stab.

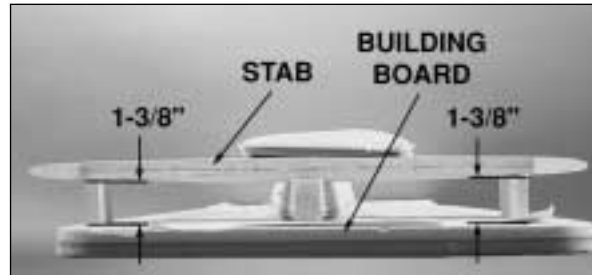

❑ 5. Position the stab on the saddle with the centerline on top of the stab in the center of the fuse. Place a weight on top of the stab to hold it down. View the fuse from the rear and make sure the stab is level. If necessary, shift the weight or **carefully** sand the *high* stab saddle until the stab will rest level.

Hint: Position a 1-3/8" [35mm] balsa block under both sides of the stab. This way you will be sure both sides are an equal distance from your building board and the stab is level.

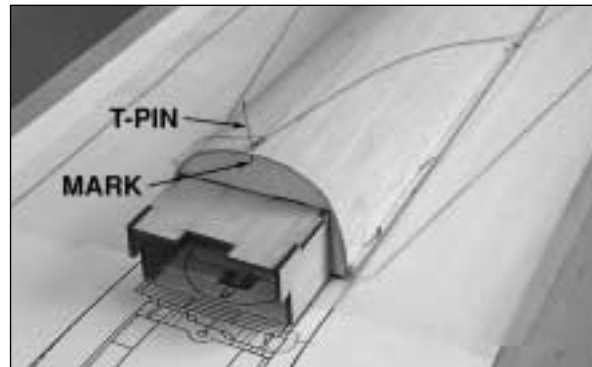

❑ 6. Insert a T-pin through the sheeting and the stringer in the center of the fuselage behind the mark you made in the upper firewall former. Tie a small loop in one end of a 42" [1070mm] length of string and slip it over the T-pin in the front of the fuselage.

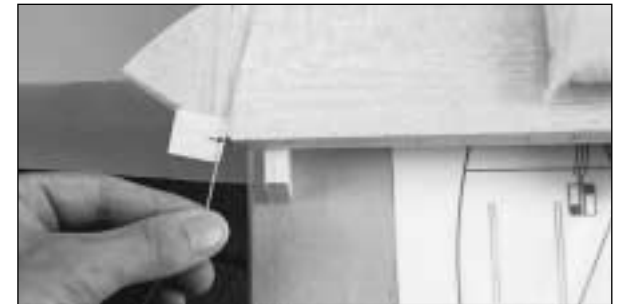

❑ 7. Fold a piece of masking tape over the other end of the string and draw an arrow on it. Slide the tape along the string and align the arrow with one tip of the stab. Swing the string over to the other stab tip. Swing the string over to the other stab tip. Shift the stab and slide the tape along the string until the distance between both ends of the stab and the front of the fuse is equal. Now your stab is centered and square with the fuse.

❑ 8. If you haven't already done so, final-sand the stab before you glue it to the fuse. It's easier to do when it's off the fuse than it is when it is glued in place!

❑ 9. Now that you are sure the stab will align, glue it to the fuse sheeting and the ply stab saddle with 30-minute epoxy. Use the pin-and-string technique to recheck your alignment. Wipe away excess epoxy before it cures. Do not build up a fillet between the stab and the fuse. Do not disturb the fuse until the epoxy is fully cured.

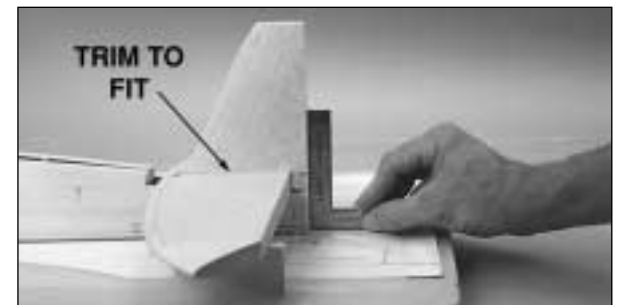

❑ 10. Taper the trailing edge of the fin so it will fit between the sheeting on the fuse. Fit the fin to the

stab. Trim the leading edge and the sheeting on both sides of the fin until it fits the stab. If necessary, enlarge the opening you cut in the stab sheeting so the leading edge of the fin will *straddle* the center rib. When the fin trailing edge contacts your building board and is perpendicular, the fin is ready to glue in place (see the following steps).

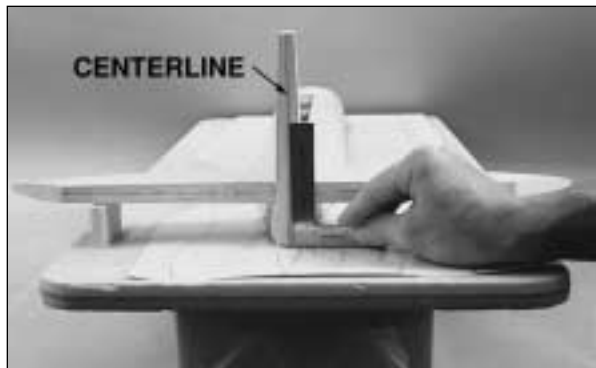

❑ 11. Trim the fuse sheeting even with the TE of the fin. Align the centerline you drew on the TE of the fin (for hinging) with a square to make sure the fin is vertical.

❑ 12. Did you final-sand the fin yet? Now is the time to do it if you haven't already.

❑ 13. Use 30-minute epoxy to glue the fin to the stab and the fuse. Make a small fillet of epoxy and microballoons or milled fiberglass between the fin and the stab. Do not disturb the assembly until the epoxy has fully cured.

❑ 14. Draw a centerline on the top of the 1/4" x 1-3/4" x 24" [6.4 x 44 x 610mm] balsa **turtle deck top** and test fit it to the fuse. Bevel the aft end to match the leading edge of the fin and shape the sides as closely as possible to match the turtle deck (the idea is to do as much of the shaping of the turtle deck as possible before you glue it in place).



❑ 15. Glue the turtle deck top in place. Finish shaping the turtle deck top the rest of the way to blend with the fuse as shown in the cross sections on the plan.



❑ 16. Remove the T-pins and take the fuselage off your building board. Fill in most of the large spaces between the fuse sheeting and the fin and stab with leftover 3/32" [2.4mm] balsa. It doesn't have to be perfect because you are going to cover most of it up with lightweight balsa filler.



❑ 17. Glue a piece of leftover 3/32" [2.4mm] balsa to both sides of the die-cut 1/16" [1.6mm] plywood **dorsal fin**. Glue the dorsal fin to the fuse and the fin.

❑ 18. Blend the dorsal fin to the fuse and fin with lightweight filler. Don't try to apply all the filler at one time but build up several thin layers, allowing your filler to dry thoroughly before you sand it and apply the next layer. You don't have to do it all now. You can work on the fin filler as you proceed with the rest of the model (you can see what the dorsal fin should end up looking like with the filler in the photo at step 8 on page 47.)

FINISH FRAMING THE FUSELAGE

❑ 1. Turn the fuselage upside down and place it in a support stand. Reinforce glue joints you missed or couldn't reach while the fuse was pinned to your building board.

All the parts used in this section (*Finish framing the fuselage*) are die-cut 1/8" [3.2mm] plywood unless otherwise noted.

❑ 2. Refer to the following photo, then glue former **1BB** to the back of **1AB**. From now on this assembly will be referred to as **former 1B**. Glue the three **firewall formers** together so all the tabs align. Make sure the front former is the one with the punchmarks and the grain direction is alternating on each piece. From now on this assembly will be referred to as the **firewall**.

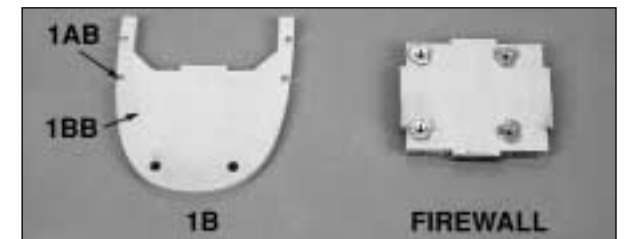

❑ 3. Drill 1/4" [6.30mm] holes through the four punch marks in the firewall. Use a hammer to lightly tap four 8-32 blind nuts into the holes from the back of the firewall and secure them with a few drops of CA.

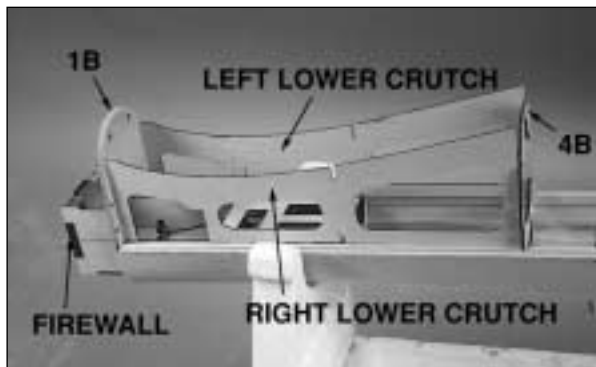

❑ 4. Position the **left** and **right lower crutches** on the upper crutches using the firewall, former **1B** and former **4B** to hold the crutches in place. Glue the lower crutches to the upper crutches and the servo tray using the formers and the firewall to hold them in alignment. **Do not** glue the firewall yet.

❑ 5. Drill 3/16" [4.7mm] holes through the punch marks in former 4B. Add the **tank floor** to the assembly. Glue former 1B, the tank floor and former 4B in place.

❑ 6. Glue formers **2B** and **3B** to the left and right crutches.



❑ 7. Glue the die-cut 1/8" balsa **formers 6B** through **10B** to formers 6 through 10 respectively. Use a straightedge to make sure the bottom formers align with the top formers.

❑ 8. Glue four 3/16" x 3/16" x 36" [4.8 x 4.8 x 914mm] stringers and four 3/16" x 3/16" x 24" [4.8 x 4.8 x 610mm] stringers in the notches of the formers. Hold formers 6B through 10B in alignment as you glue the stringers to them.

Note: All the stringers end in the middle of former 10B.

MOUNT THE TAIL WHEEL ASSEMBLY

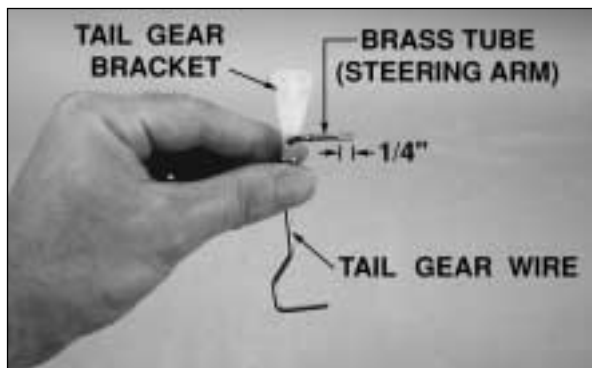

Use this photo for step 1 and 2.

CUT OFF THE AFT ALIGNMENT POST

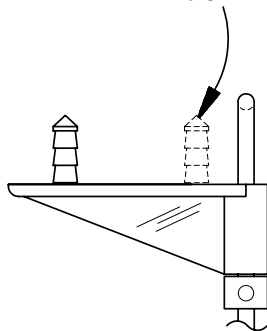

❑ 1. Cut the aft **alignment post** off the nylon **tail gear bracket**. Use a pliers to flatten 1/4" [6.4mm] of one end of the 1/8" x 5/8" [3.2 x 15.9mm] brass tube. Slide the tube onto the **tail gear wire** and place the assembly over the plan to make sure it is the correct length. Shorten the *torque arm portion* of the tail gear wire if necessary.

❑ 2. Silver solder the brass tube to the tail gear wire. Drill a 1/16" [1.60mm] hole through the end of the brass tube where shown on the plan. From now on this portion of the tail gear wire will be referred to as the **steering arm**.



Refer to this photo for steps 3 through 7.

❑ 3. Drill 1/16" [1.60mm] holes through the two punch marks in the front of the die-cut 1/8" [3.2mm] plywood **tail gear plate** and a 1/8" [3.10mm] hole through the aft punch mark. Glue a piece of leftover 1/8" [3.2mm] plywood over the 1/16" [1.60mm] holes and re-drill them through the ply plate you just glued on. Make sure the plywood strip will fit between the main fuse stringers.

❑ 4. Mount the tail gear bracket to the tail gear plate with two #2 x 3/8" [9.5mm] screws.

❑ 5. Cut a slot in the right side of the fuse sheeting for the steering arm to pass through. Refer to the fuse plan and take measurements from the tail gear plate to find the exact location of the slot.

❑ 6. Place the tail gear plate and the tail gear bracket on the fuse to make sure the slot in the stab saddle and the fuse side is in the correct location. Make adjustments if necessary. Take the tail gear plate off the fuselage and set it aside.

7. Cut a 3/16" x 36" [4.8 x 914mm] **pushrod guide tube** to a length of 29" [735mm]. Sand the guide tube with coarse sandpaper so glue will stick when it's time to glue it in place. Slide the tube through the holes in the formers as shown on the plan until it reaches the right fuse side just behind former 10. This is where the guide tube will exit the fuselage.

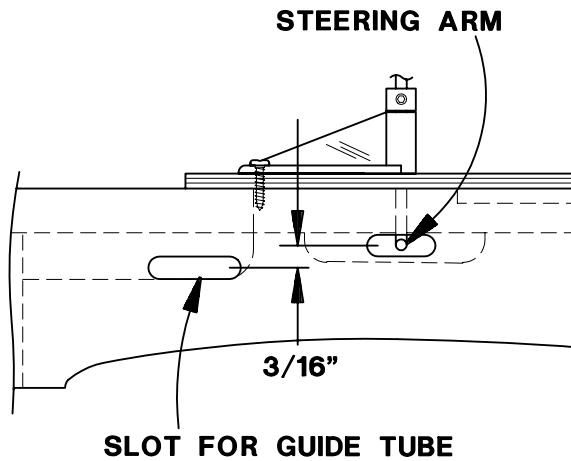

8. Cut a slot in the fuse side for the guide tube. The center of the slot should be 3/16" [4.8mm] above the steering arm so the pushrod will align with the ball when you mount it to the steering arm.

9. Refer to the sketch in step 10. Bevel the aft end of the guide tube so it will be flush with the fuse side where it passes through the slot. Screw a nylon **dual ended ball link** onto a **.074" x 36" [1.9 x 914mm] wire pushrod**. Cut 6" [150mm] off the other end of the rod. Snap a **ball stud** into the dual ended ball link and slide the pushrod into the guide tube from the rear.

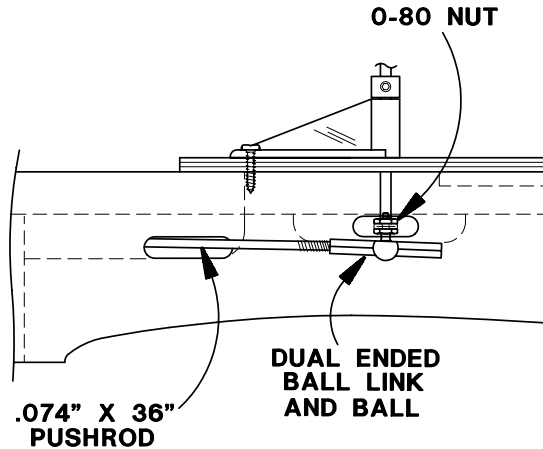

10. Reposition the tail gear plate on the fuse. Fit the ball stud onto the steering arm and temporarily secure it with a 0-80 nut. Move the pushrod back and forth to test the action of the tail gear wire. Make sure there is no interference and everything is in alignment. Make adjustments where necessary.

11. Disconnect the ball stud from the steering arm and remove the pushrod from the fuse but leave the guide tube in place. Glue the guide tube in the slot in the fuse with a mixture of epoxy and microballoons. Glue the guide tube to the formers with CA. After the epoxy cures sand the guide tube flush with the fuse side.

12. Raise or lower the tail gear wire in the nylon bracket until the steering arm is centered in the slot in the fuse. Secure the **wheel collar** to the tail gear wire with a small **set screw** and a drop of thread lock.

13. Use epoxy and microballoons leftover from step 12 (or mix up a new batch) to make a small fillet between the stab and the stab saddles **inside** the fuselage.

While we're at it, let's install the elevator pushrod guide tube.

14. Cut another 3/16" x 36" [4.8 x 914mm] pushrod guide tube to a length of 29" [735mm] and sand it so glue will stick. Slide the tube through the holes in the formers until it reaches the left fuse side just behind former 10. Cut a slot in the fuse for the pushrod to exit and glue it in place the same way you did for the rudder guide tube. After the epoxy cures, sand the tube flush with the fuse side.

PREPARE THE FUSE FOR SHEETING

Disregard the fuselage sheeting in this photo.

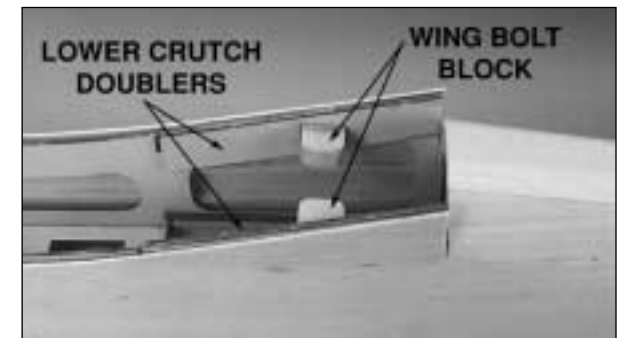

1. Glue both die-cut 1/8" [3.2mm] plywood **lower crutch doublers** to the inside of both crutches where shown on the plan (the bottom of the lower crutch doublers should align with the bottom of the crutches). Test fit both 1/2" x 7/8" x 7/8" [12.7 x 22.2 x 22.2mm] maple **wing bolt blocks** in the notches of the lower crutch doublers.

Make adjustments if necessary and round the inside corners of the blocks for a finished appearance. Securely glue the wing bolt blocks in place with 30-minute epoxy and make small fillets of epoxy around the blocks, where they meet the doublers.

❑ 2. Sand the edges of the die-cut 1/4" [6.4mm] balsa former 11 the same way you did the bottom of the fin trailing edge to accommodate the tapering angle of the fuse sheeting. Glue former 11 to the bottom of the fin trailing edge.

❑ 3. Position the tail gear plate (with the tail gear bracket) on the fuse but **do not** glue it in place until instructed to do so. This will allow you to remove the tail gear bracket so it won't be in the way when you shape the bottom of the fuse later.

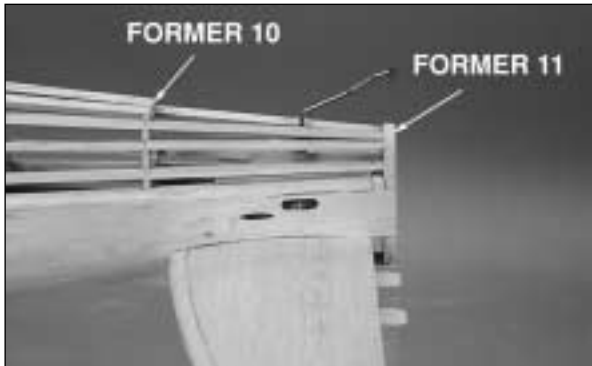

❑ 4. Use a 3/16" x 3/16" x 24" [4.8 x 4.8 x 610mm] balsa stick and leftover stringers to make the stringers that extend from former 10 to former 11. Glue them in place.

❑ 5. Make sure all glue joints are secure and add CA to those that aren't. Blend the formers and the stringers to each other by sanding them with a bar sander and 150-grit sandpaper.

❑ 6. Glue the upper fuse sheeting to the side and main stringers near the back of the fuselage.

SHEET THE BOTTOM OF THE FUSE

Sheet the right side first so it will look like the photos.

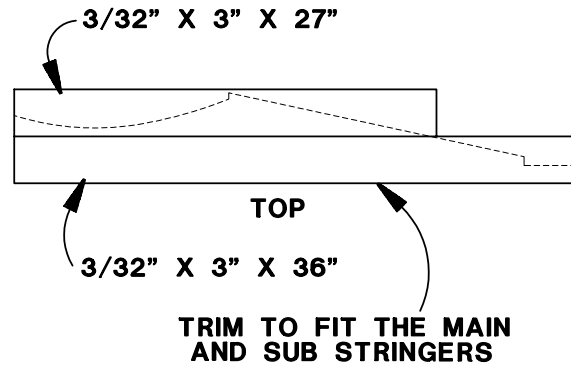

❑ ❑ 1. Trim one edge of a 3/32" x 3" x 36" [2.4 x 76 x 914mm] balsa sheet so it fits the *ledge* made by the main stringer and the sub stringer on the right side of the fuse. Trim another 3/32" x 3" x 36" [2.4 x 76 x 914mm] balsa sheet to a length of 27" [690mm]. True the edges and glue the 27" [690mm] piece to the bottom of the first sheet to make the skin for the bottom of the right side of the fuse.

❑ ❑ 2. Tape the skin to the right side of the fuselage and mark where to trim it along the lower crutch, former 4B and the bottom right stringer.



❑ ❑ 3. Take the skin off the fuselage and trim it as described above, making it a little oversize to allow for positioning.



❑ ❑ 4. If you wish to install an internal antenna tube (not provided), now is the time to do so. Position the skin on the fuse and glue it to the main and sub stringer only.



❑ ❑ 5. Wet the sheet with alcohol. One small section at a time, carefully bend the skin to the formers and stringers and glue it in place with thin and medium CA as required. Add a piece of leftover 3/32" [2.4mm] balsa to the end of the sheet so it extends all the way to the back of the fuse.

❑ ❑ 6. Return to step one and make the skin for the left side of the fuse and glue it in place the same way.

❑ ❑ 7. Sand the bottom of the fuse sheeting and the bottom stringers so they are even with the bottom of formers 4B through 10 (the same way you did with the top of the fuse for the turtle deck).

❑ ❑ 8. Glue the 1/4" x 2" x 19" [6.4 x 51 x 483mm] **aft fuse bottom** in place. Roughly shape it to match the fuse cross sections on the plan but do not final shape it yet.



❑ 9. Unscrew the #2 x 3/8" [9.5mm] screws that hold the tail gear bracket to the tail gear plate and remove the bracket and tail gear wire. Trim the sheeting along the bottom stringers between formers 10 and 11.

❑ 10. Temporarily *tack glue* the 3/8" x 3/4" x 6" [9.5 x 19.1 x 152mm] **bottom tail blocks** to the bottom of the fuse. Shape the blocks to match the curvature of the bottom of the fuse as shown on the cross sections on the plan and the photo at step 12. While you're at it, temporarily install the rudder with the hinges and blend the bottom of the rudder and the fuse to each other.

❑ 11. *Break* the bottom tail blocks off the fuse. Permanently mount the tail gear bracket to the tail gear plate and secure the screws with a few drops of thin CA. Position the tail gear plate and securely glue it to the main stringers.

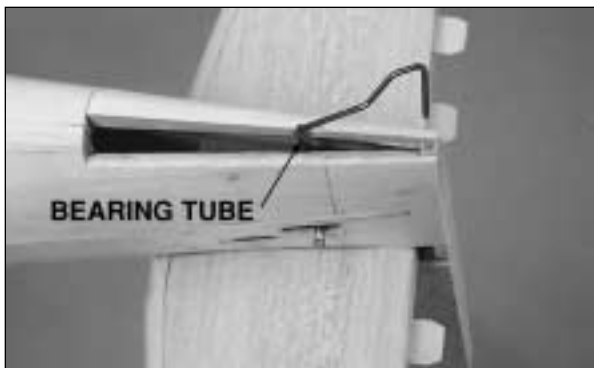

❑ 12. Drill a 5/32" [4.00mm] hole through the bottom tail blocks to accommodate the **nylon bearing tube** on the tail gear wire. Glue the bottom tail blocks in position.

❑ 13. Cut the hinge slot in the fuselage and the bottom of the rudder. Drill the 3/32" [2.40mm] hole in the center of the hinge slots and test fit a hinge as described earlier in the manual when you were fitting the elevators.

FINAL CONSTRUCTION

MOUNT THE WING TO THE FUSELAGE

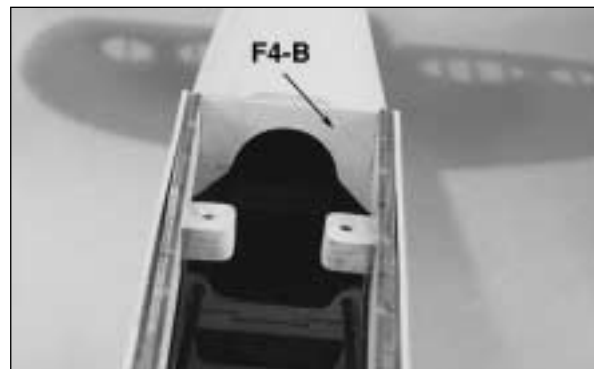

❑ 1. Glue the die-cut 1/8" [3.2mm] plywood **former F4-B** to former 4 and the lower crutches.

❑ 2. Trim the fuse sheeting even with the lower crutches. Test fit the wing on the fuselage. *This is the moment of truth!* Slightly enlarge the holes in the bottom of former F1 to accommodate the wing dowels if necessary. Trim the balsa fuse sheeting near the leading edge of the wing until the wing fits.

❑ 3. Locate the holes in the wing bolt plate under the bottom wing sheeting (the holes should be 2-1/4" [57mm] ahead of the TE and 1" [25.4mm] on both sides of the wing centerline). Use a hobby knife to cut 1/4" [6mm] holes in the sheeting for the wing bolts.

❑ 4. Place the wing on the fuselage and use the *pin-and-string technique* to align the wing, only this time stick the T-pin in the center of the fuselage at the rear.

❑ 5. See the **Hot Tip** that follows and use a #10 [4.90mm] (or 3/16") drill to drill through the holes in the wing bolt plate into the wing bolt blocks in the fuselage. The wing **must not shift** during this procedure or you will lose your alignment. Also, you must hold your drill perpendicular to the bottom of the wing while drilling. Secure the wing to the fuselage with masking tape or weights if you feel it is necessary. Take a deep breath, steady your hands and drill the holes. If you seem to have had difficulty with this procedure in the past, you could just *dimple* the wing bolt blocks by letting the spinning drill bit barely contact them and *backing off* before you actually drill a hole. Remove the wing and make sure you will be drilling the holes near the center of the blocks. Reinstall the wing, check alignment and finish drilling the holes.



If you have a drill press (or if you can use a friend's), make a *drill jig* by drilling a #10 [4.9mm] (or 3/16") hole through an approximately 1" x 1-1/2" x 2" [25 x 38 x 50mm] wood block. Use the block to hold your drill bit perpendicular to the bottom of the wing as you drill the holes. This will help you *aim* the drill directly toward the wing bolt blocks so the heads of your wing bolts will rest **flat** on the bottom of the wing. You can use this drill jig on all your models.

- ❑ 6. Take the wing off the fuse. Tap threads in the wing bolt blocks with a 1/4-20 tap. Enlarge the holes **in the wing only** with a 17/64" [6.70mm] drill bit. Bolt the wing to your fuselage with 1/4-20 nylon **wing bolts**.

NOW does it look like a Spitfire? We're only missing a few things—namely that characteristic wing fillet and the front end of the fuselage. You're almost there, so keep going!

BUILD THE WING FILLET

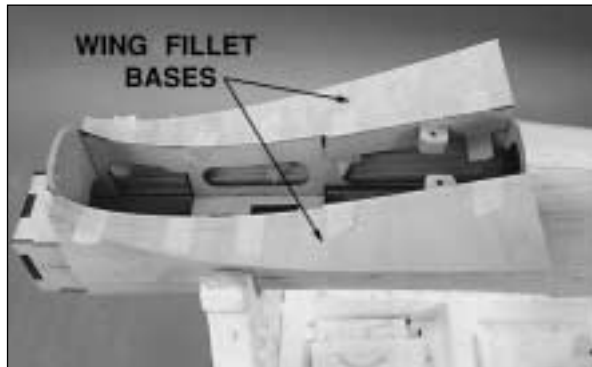

- ❑ 1. Temporarily tape both die-cut 1/32" [0.8mm] plywood **wing fillet bases** to the lower fuselage crutch.

- ❑ 2. Bolt the wing to the fuselage and view the model from the rear. Observe the horizontal alignment between the wing and the stabilizer. If necessary, loosen the wing bolts and insert shims from leftover balsa between the wing fillet bases and the fuselage to bring the wing into alignment with the stab. Tighten the wing bolts.

- ❑ 3. Make sure the aft edge of both wing fillet bases *end* at the trailing edge of the wing. If necessary, trim the saddle bases to achieve this.



- ❑ 4. Cut the molded plastic **wing fillets** along the cutlines. Test fit the wing fillets to the fuselage so you can see how they fit.

- ❑ 5. Turn the fuselage over and remove the wing. Cover the middle of the wing with waxed paper so glue will not stick.

- ❑ 6. Remove the fillet bases and apply a mixture of 30-minute epoxy and microballoons to the lower crutches and the fuse side. Retape the fillet bases to the lower crutches and bolt the wing to the fuselage. Wipe away excess epoxy.

- ❑ 7. Position the fillets on the fuselage and glue them to the saddle bases and fuse with medium and thin CA as needed. Don't worry if you can't get the plastic fillets to fit perfectly all around the leading edge of the wing. You can finish that with filler.

- ❑ 8. After the epoxy mixture has cured, remove the wing and take the waxed paper off. Trim the edges of the fillet base to within approximately 1/8" [3mm] from the plastic fillet. This will leave a little *ledge* for the filler so you can sand it down to a thin edge.

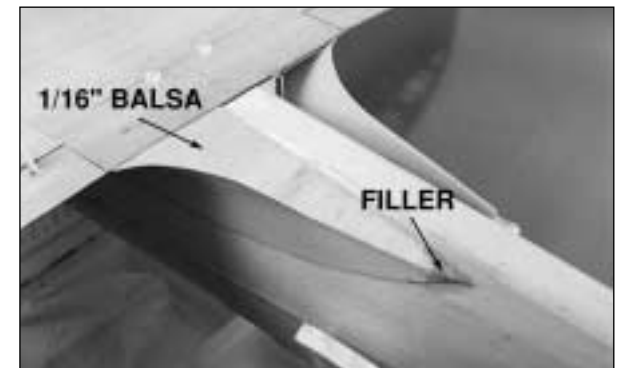

- ❑ 9. Bolt the wing onto the fuselage. Make the aft portion of the fillet base from leftover 1/16" [1.6mm] balsa, connecting the rest of the fillet to the fuselage. Finish the aft tip of the fillet by blending the balsa and plastic to the fuselage with filler. We used Bondo body filler because it adheres to plastic and wood.

❑ 10. Blend the fillet to the fillet base and the fuselage with automotive Bondo, Squadron white or green putty or an other suitable filler. Sand when dry.

❑ 11. Blend the bottom portion of the fillet to the fuselage with lightweight balsa filler.

BUILD THE BOTTOM WING FAIRING

❑ 1. Cover the bottom of former 1 with leftover 3/32" [2.4mm] cross-grain balsa.

❑ 2. Glue both 5/8" x 1-5/8" x 3-1/4" [15.9 x 41.3 x 83mm] balsa blocks together to make one 5/8" x 3-1/4" x 3-1/4" [15.9 x 83 x 83mm] **wing fairing block**.

❑ 3. Carve the block to the *approximate* shape shown on the plans and in the following photo, but leave it slightly oversize so you can final shape it after you glue it to the wing.

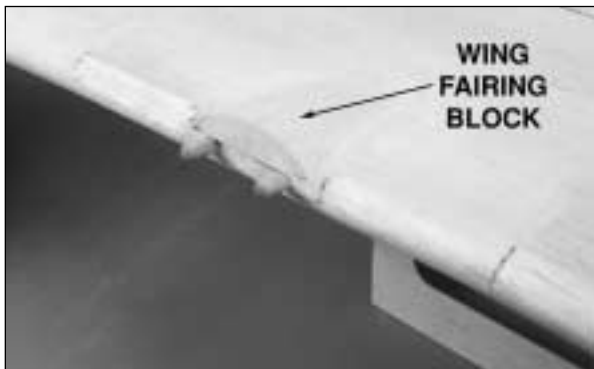

❑ 4. With the wing bolted to the fuselage, glue the wing fairing block to the wing. Shape the wing fairing block as you simultaneously blend it to the fuselage and the wing. Fill the small gap between the leading edge of the wing and the fuselage with leftover balsa. Remove the wing and finish the job with a little balsa filler, sanding as needed.

❑ 5. Now that the fuse is nearly complete, mount a 1-1/4" [32mm] tail wheel to the tail gear and mount the wing to the fuse. Set the model on its wheels and make sure both wing tips are the same distance from the ground. If they are not, adjust the axles on the main landing gear wire until the wing tips are equal distances from the ground.

NOTE: If any adjustments need to be made, try to split the difference between both gears. As a final check, retract the wheels to make sure they both fit into the wells without interference.

❑ 6. Cut the landing gear wires so they are flush with the bottom of the axles.

MOUNT THE ENGINE AND COWL



❑ 7. If you haven't done so already, trim the fuselage sheeting even with former 1. Bolt the wing to the fuselage. Test fit the laser-cut 1/8" [3.2mm] plywood **wing dowel doubler** to the front of former 1 over the wing bolts as shown on the plan. Glue the doubler to former 1, but remove the wing and use clamps to hold the doubler in position while the glue dries.

❑ 8. Glue the die-cut 1/8" [3.2mm] plywood **tank roof** into the fuselage.

❑ 9. Test fit your fuel tank and determine where to drill the holes in the firewall for the fuel lines. Before you drill the holes, make sure the engine mount will not cover them. Drill 1/4" [6.30mm] (or 15/64" [6.00mm] for a perfect fit) holes in the firewall for the fuel lines to pass.

❑ 10. Glue the firewall to the fuselage with 30-minute epoxy. Hold it in place with clamps and masking tape until the epoxy cures.

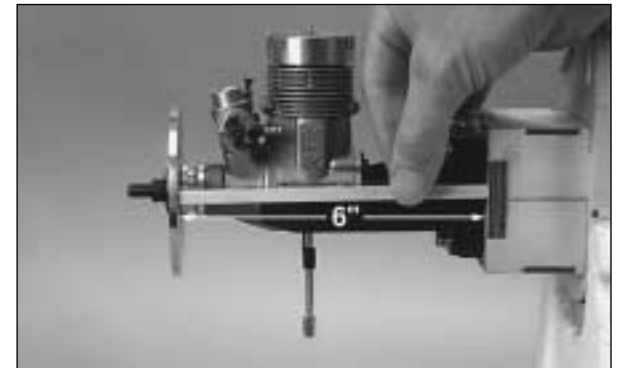

❑ 11. Temporarily mount the engine mount to the fuselage with four 8-32 x 1-1/4" [32mm] socket head screws, #8 lock washers and flat washers. Place your engine on the mount with your spinner backplate in position. Cut a leftover balsa stick to a length of 6" [152mm] and use it as a *gauge* to position the engine so the back plate of your spinner (on both sides) will be 6" [152mm] from the firewall. Use a small C-clamp to hold your engine to the mount while you mark the locations of the mounting bolts.

Hint: Heat the end of a pointed wire with a torch and *dimple* the engine mount in the center of each hole.

❑ 12. Remove the engine from the mount and drill four #29 [3.40mm] (or 9/64") holes at the marks. Tap 8-32 threads into the holes and mount your engine with four 8-32 x 1" [25.4] socket head cap screws.

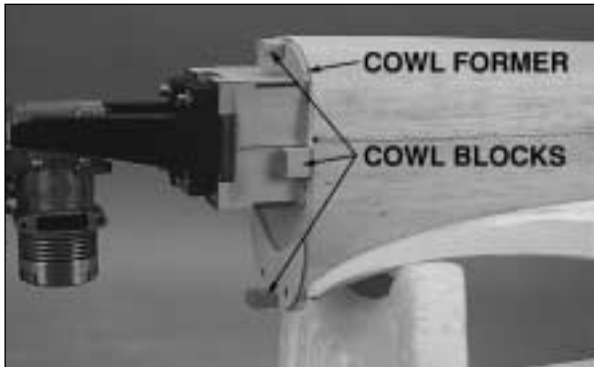

- ❑ 13. Glue the die-cut 1/8" [3.2mm] plywood **cowl former** and the four 3/8" x 5/8" x 5/8" [9.5 x 15.9 x 15.9mm] hardwood **cowl blocks** in place.

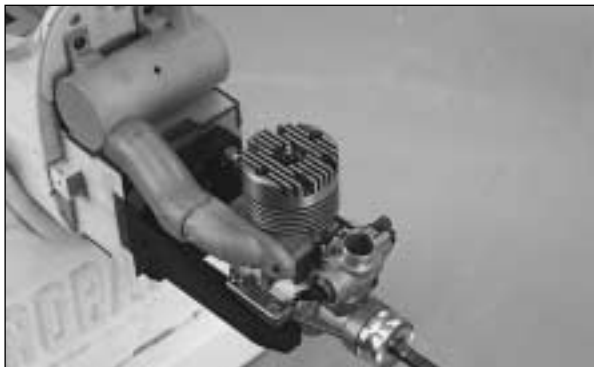

- ❑ 14. Mount your exhaust system. We used the Top Flite In-Cowl Warbird Muffler and appropriate Top Flite In-Cowl header. Since the muffler is far

from the engine, you must use a long Silicone tube to connect them. We used an Aerotrend 3/4" [19mm] (inside diameter) Silicone tube (AERG2220) with the included *spring-sleeve* inside the tube to prevent the hot exhaust gas from burning through the silicone. Before you mark the location of the muffler mounting screw holes, temporarily insert a 3/32" [2.4mm] balsa *spacer* between the muffler and the tank floor so the top of the muffler does not contact the fuel tank floor.



- ❑ 15. Cut the molded right and left ABS **cowl halves** along the cutlines. Hobbico (HCAR0667) or Kyosho (KYOR1010) curved plastic cutting scissors work well for this. True any jagged edges with a bar sander and 80-grit sandpaper.

- ❑ 16. **Thoroughly** sand the inside and the outside of the joining edges of both cowl halves with 150 to 240-grit sandpaper. Basically, you should sand everywhere you want glue and filler to adhere, including a 1" [25mm] wide strip along the joining edges of both cowl halves.

- ❑ 17. Join the cowl halves and hold them together with masking tape. Glue the cowl halves together with thin CA. Avoid using accelerator because it may soften the plastic.



- ❑ 18. Place the cowl on the fuse and put your spinner backplate on your engine. Align the front of the cowl with the spinner backplate. Use a pencil to mark any *high spots* that need to be trimmed at the rear of the cowl. Remove the cowl, trim, then test fit again. Continue to test fit and trim as necessary until the cowl fits the fuselage and you have a 3/32" [3mm] gap between the front of the cowl and the spinner.

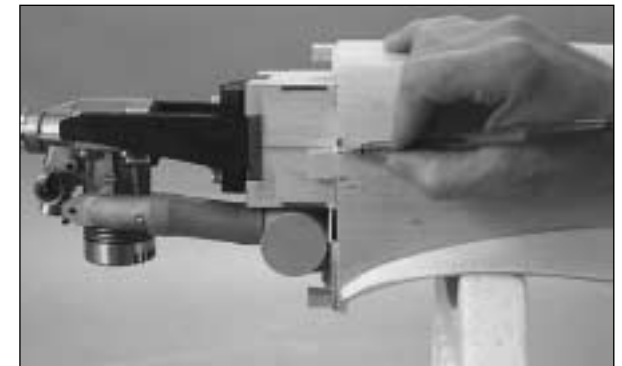

- ❑ 19. Once you are satisfied with the fit of the cowl, mark the location of the cowl mount blocks on the fuse.

- ❑ 20. Position the cowl and hold it to the fuselage with tape. Drill 3/32" [2.40mm] holes through the cowl and the cowl mount blocks 3/8" [9.5mm] forward of the aft edge of the cowl. Don't worry if the top and bottom holes you drill are on the seam because you will reinforce the cowl with glass cloth.



❑ 21. Use 30-minute epoxy or thin CA to apply a 1" [25mm] wide strip of glass cloth over the seams and screw holes inside the cowl, where indicated in the photo. Thoroughly sand these areas first, for a good bond. If you use CA, make sure you do this in a **well ventilated area** and avoid inhaling the fumes. Avoid using accelerator.

❑ 22. Enlarge the holes **in the cowl only** with a 1/8" [3.10mm] drill bit. Test mount the cowl to the fuselage with four #4 x 3/8" [9.5mm] screws. Make adjustments if necessary and remove the cowl.

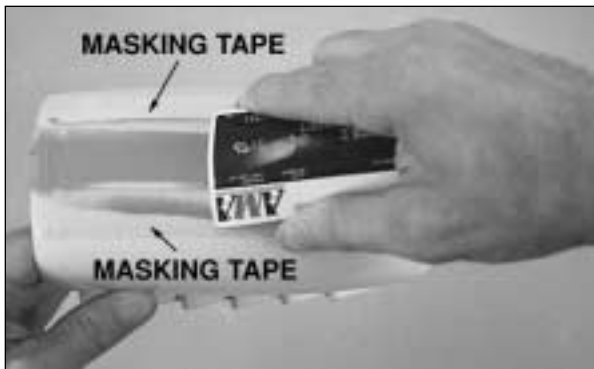

❑ 23. Fill the seams in the cowl with Bondo or other suitable filler. Use an expired credit card or a piece of plastic as a spatula to apply the filler. Bend your spatula as you apply the filler to build up a slight mound over the seams. Notice the masking tape on both sides of the seam. After you apply the filler, you can peel off the masking tape, removing excess filler with it.

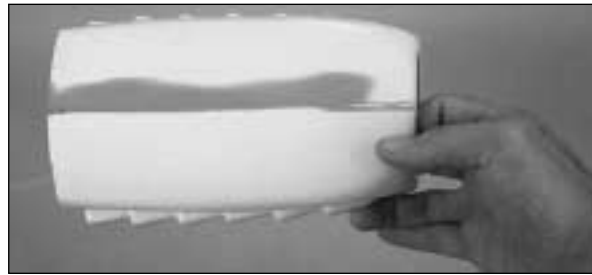

❑ 24. After the filler has fully cured, wet-sand with progressively finer grits of sandpaper. When you're done, your cowl should look something like the one in the photo—just enough filler left to fill in the low spots near the seams.

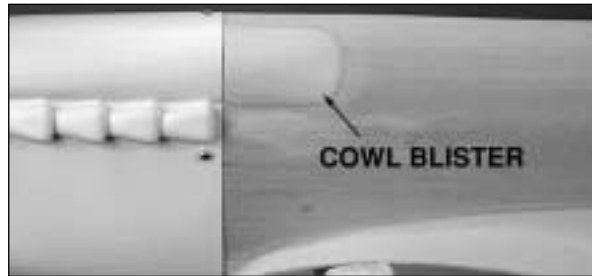

❑ 25. Cut both molded plastic **aft cowl blisters** along the cutlines. Trim where necessary so the blisters fit the cowl and the fuselage. Glue the blisters in place and blend to the fuselage with filler, then sand.



❑ 26. Mount your fuel filler valve. We used the Great Planes Easy Fueler™ and made a mount from leftover 1/8" [3.2mm] plywood to hold it up close to the cowl for easy access.



❑ 27. Cut holes in the bottom of the cowl for air intake and outlet. Generally, the air exit hole should be twice the size of the air intake hole. Make holes for the glow plug igniter, exhaust, needle valve and fuel filler as well.

HOOK UP THE CONTROLS

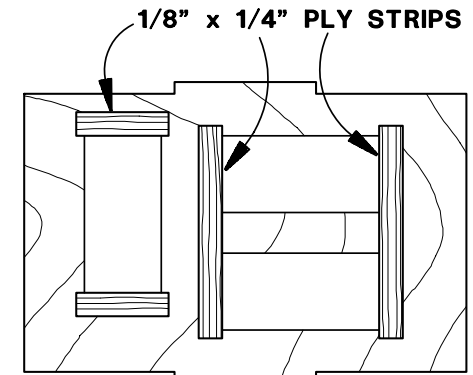

SERVO TRAY (AS SEEN WHEN YOU ARE BUILDING THE MODEL UPSIDE DOWN)

❑ 1. Cut 1/8" x 1/4" [3.2 x 6.4mm] plywood doublers from leftover plywood and glue them across the servo tray as shown in the sketch.

❑ 2. Place your throttle servo with a servo horn in the servo tray. Drill a 3/32" [2.40mm] hole through former 1 to allow the throttle pushrod to pass. Temporarily install your fuel tank.



3. Make the **throttle pushrod** from a .074" x 12" [1.9 x 305mm] pushrod and a nylon clevis. Bend the pushrod as necessary and connect the clevis to the carburetor. Connect other end of the pushrod to the servo with a screw lock pushrod connector.

4. Install your rudder and elevator servo in the servo tray. Drill 1/16" [1.60mm] holes in the servo tray and mount your servos with the screws that came with your radio.

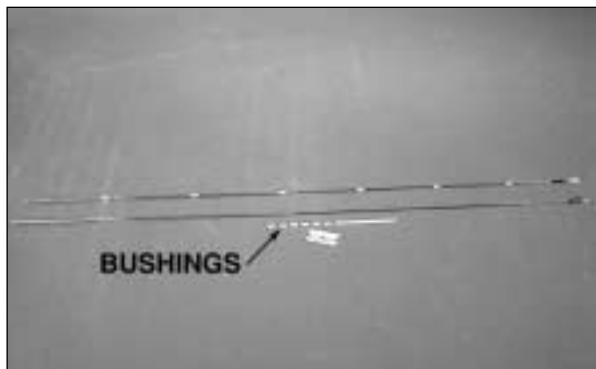

5. Cut a .074" X 36" [1.9 x 914mm] pushrod to a length of 30" [760mm]. This is the elevator pushrod. Clean residual oil from the elevator and rudder pushrod wires with a cloth dampened with alcohol or

other solvent. Cut twelve 3/8" [9.5mm] long **bushings** from the white inner pushrod tube, then slide them, evenly spaced, onto both elevator and pushrod wires. Make sure you position the bushings at the ends of the wires so they will not protrude from the guide tubes, or the controls could become jammed during flight. If the bushings slide onto the wires easily, secure them with a drop of thin CA. If the bushings are difficult to slide on, cut them to a shorter length. Make sure the CA sets before you slide the pushrods into the guide tubes! Thread a nylon clevis about 15 full turns onto the elevator wire.

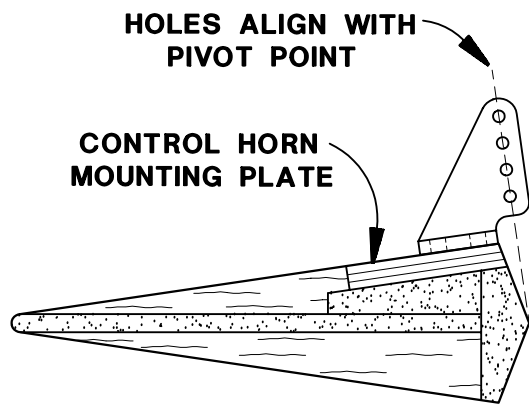

6. Connect a small nylon control horn to the clevis on the elevator pushrod. Slide the pushrod into the elevator pushrod guide tube and rest the control horn on the control horn mounting plate on the elevator. Mount the control horn to the elevator as shown in the sketch with two #2 x 3/8" [9.5mm] screws.

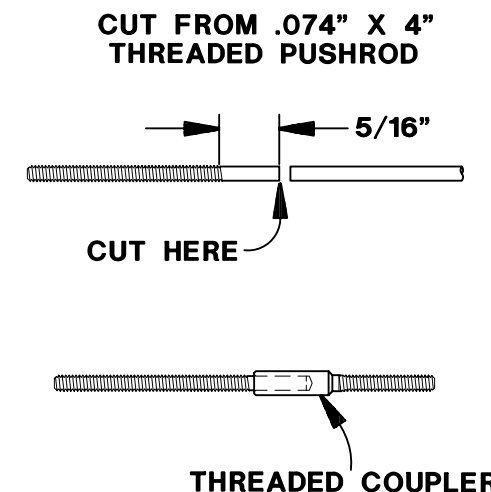

7. Slide the rudder pushrod into the rudder pushrod guide tube. Temporarily connect the ball stud to the steering arm with the #0-80 nut. Cut the unthreaded portion of a .074" x 4" [1.9 x 102mm] **pushrod** as shown in the sketch so only 5/16" [8mm] remains. Silver solder the rod to a **threaded coupler**. Connect the rudder to the ball link on the steering arm using the pushrod you just made, a nylon clevis, a small nylon control horn and two #2 x 3/8" [9.5mm] screws. Shorten the pushrod as necessary so that when the tail wheel is centered, so is the rudder.

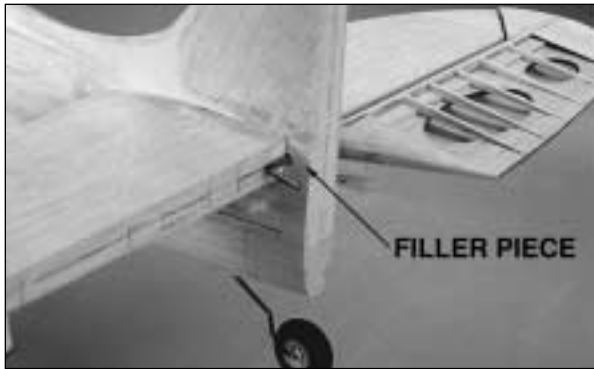

Refer to this photo for steps 8 through 11.

- ❑ 8. If you have the elevators temporarily attached to the stab, remove them for now. Cut two *filler pieces* from leftover 3/32" [2.4mm] balsa to fit between the fin sheeting and the fuse sheeting behind the stab TE on both sides of the fuse. Do not glue them in yet.
- ❑ 9. Cut a small, round *notch* in the front edge of both filler pieces to accommodate the elevator joiner wire.
- ❑ 10. Roughen the elevator joiner wire with sandpaper so glue will stick.
- ❑ 11. Insert the elevator joiner wire into the fuse and glue the filler pieces in place. Be careful not to get glue on the elevator joiner wire so that it is free to pivot. Blend the filler pieces to the fuse with a little filler if needed and sand to shape.

INSTALL THE RADIO

Some modelers prefer to install the radio **after** they cover the model. If this is your decision, skip to *Prepare the model for covering* on page 49, then return to this section when you're done.



- ❑ 1. Center the rudder and tail wheel. Use a felt tip pen to mark the rudder pushrod where it crosses the holes in the rudder servo arm.
- ❑ 2. Make a 90-degree bend in the pushrod at the mark you made. Snap a nylon Faslink onto the wire and cut the wire so approximately 1/16" [1mm] protrudes from the Faslink.
- ❑ 3. Enlarge the holes in the rudder servo arm with a #48 [1.90mm] (or 5/64") drill or a hobby knife. Connect the pushrod to the servo arm with the Faslink.
- ❑ 4. Connect the elevator pushrod to the elevator servo the same way.
- ❑ 5. Study the plans and the following photos to decide how you will mount your receiver, battery pack, servo for the retract air control valve and the air control valve itself. We've included a removable **bottom servo tray** for this purpose. Mount your receiver, retract servo and air control valve to the bottom servo tray, or fashion your own mounting system for these items.

Note: If you plan to install the Top Flite Spitfire Scale Cockpit Interior kit, an alternate location to mount your receiver would be on the cockpit floor shown on page 48. Make certain the cockpit floor is securely glued into the fuselage if this is where you decide to mount your receiver.

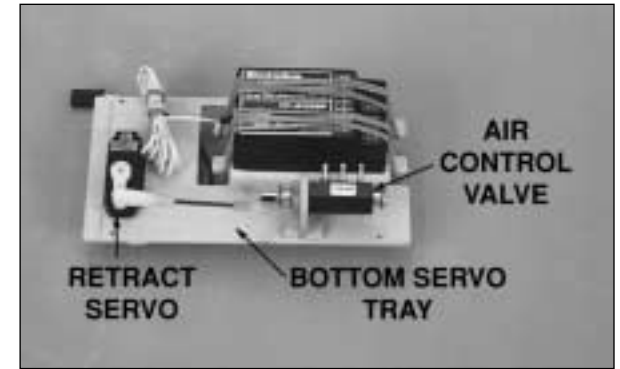

- ❑ 6. Connect the retract servo to the air control valve with the hardware of your choice. We used a 2-56 threaded rod with a clevis on one end and a ball link on the other end.
- ❑ 7. Cut **bottom servo tray rails** from the 3/16" x 1/4" [4.8 x 6.4mm] basswood stick and glue them to the lower crutches as shown on the plan. Plan your installation carefully and test fit the bottom servo tray in the fuselage before you glue the rails in place. Make sure you position the rails so they do not interfere with the other servos.



- ❑ 8. Drill four 1/16" [1.60mm] holes through the bottom servo tray and the rails. Enlarge the holes in the bottom servo tray only with a 3/32" [2.40mm] drill bit and temporarily mount the bottom servo tray to the rails with four #2 x 3/8" [9.5mm] screws.

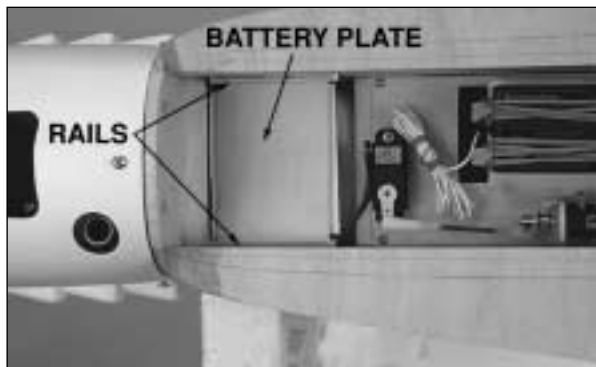

❑ 9. Mount your battery pack. On our model we used leftover 1/8" [3.2mm] plywood to make a 1/8" [3.2mm] **battery plate** and two **rails** to hold the battery pack in place. Place the plate between the fuselage sides over the battery pack (with the appropriate R/C foam rubber), press down and glue the rails to the fuse sides only. If you ever have to remove your battery pack, all you have to do is slide the plate from under the rails and take out your battery.

❑ 10. Mount your on/off receiver switch in a location that does not interfere with the rest of the radio system (or the cockpit interior if you plan to install one). It is a good practice to mount the switch on the side of the model opposite the exhaust.

❑ 11. If you're installing retracts, connect a 10-inch piece of air line that came with your retracts to your air tank. Glue the tank to formers 5B and 6B with RTV silicone or epoxy where shown on the plans.



❑ 12. Mount your air filler valve. On our prototype we mounted the filler valve to a piece of leftover 1/8" [3.2mm] plywood and glued the plywood to the lower crutch with the filler valve protruding through a hole drilled through the crutch and the balsa fuse side. Adjust the filler valve so it is flush with the outside of the fuselage.

INSTALL THE COCKPIT AND CANOPY

Proceed to step eight if you will not be installing the Top Flite Spitfire Scale Cockpit Interior kit.

❑ 1. Cut the balsa cockpit floor along the partially die-cut lines between formers 4 and 3. Remove that portion of the cockpit floor.

❑ 2. Trim the die-cut 3/32" [2.4mm] balsa **cockpit sub floor** to fit between the lower fuse crutches.

❑ 3. Now is the time to install your scale cockpit interior kit. Trim and paint the scale cockpit sides, instrument panel, back and floor according to the instructions included with your cockpit kit. Glue the cockpit floor to the balsa cockpit sub floor. From now on this will be called the cockpit floor.

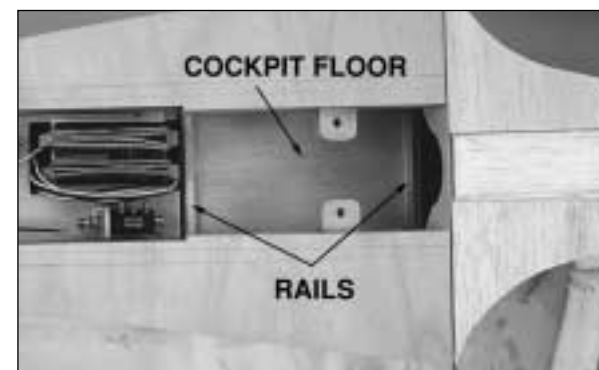

❑ 4. Place the cockpit floor inside the fuse between the crutches. Temporarily place two **support rails** cut from leftover balsa between the lower fuselage crutches to support the cockpit floor when you turn the fuselage upright. These **support rails** should have a *friction fit* so they won't fall out before you glue them in place.

❑ 5. Turn the fuselage over and test fit the cockpit sides and the instrument panel in the cockpit. Adjust the height of the cockpit floor and the support rails until the top edges of the cockpit sides are even with the tops of the balsa cockpit rails. Trim any parts of the cockpit interior as necessary for a good fit. Mark the location of both support rails inside the fuselage.

❑ 6. Remove the cockpit parts and paint them according to the instructions included with your cockpit kit.

❑ 7. Reinstall the cockpit floor, instrument panel, sides and support rails the same way you did before. Securely glue all the parts in place with CA.

❑ 8. Accurately trim the canopy along the molded cutlines. True the edges with a bar sander for a finished appearance.



❑ 9. Place the canopy on the fuselage where shown on the plan. Lightly mark the outline of the canopy on the fuselage.

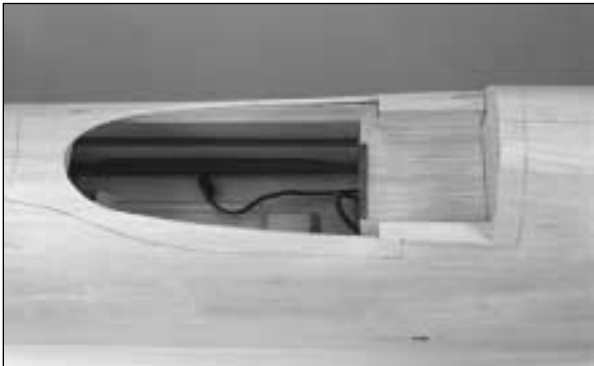

❑ 10. Remove the canopy and trim the sheeting around the cockpit as shown on the plan and in the photo. Just make sure you don't cut the sheeting too close to the canopy outline.

FINISHING

FUELPROOFING

Remove the pushrods, cowl, engine, muffler and other hardware that may interfere with final sanding and covering. See the Expert Tip below and fuelproof all areas that may be exposed to fuel or engine exhaust such as the wheel wells, the TE of the wing where the flaps are located, the firewall and engine compartment area, the fuel tank compartment, the wing saddle and the front of the wing, the wing dowels, etc. Use epoxy, epoxy paint, finishing resin or other fuelproof model paint.

Note: You should fuelproof the wheel wells **before** you cover the model. Otherwise, the paint may soak through the wing sheeting and add blemishes to your covering.



If you plan to cover your model with Top Flite MonoKote film and you will be using Top Flite LustreKote spray paint for parts that require painting and/or fuelproofing, you may find it easier to apply LustreKote to some of those parts with a paint brush instead of spraying from the can. To apply LustreKote with a brush, hold a tube (such as a drinking straw) to the spray nozzle with the other end of the tube emptying into a container. Depress the spray nozzle until you have enough paint in your container to do the job. Spraying LustreKote into a tube will keep most of it from becoming airborne. Allow the paint to stabilize for about ten minutes before you brush it on. This is a handy method for painting visible areas on the outside of the model that require fuelproofing and must match your MonoKote finish (such as the wheel wells and the TE of the wing in the flap area).

PREPARE THE MODEL FOR COVERING

❑ 1. Inspect all surfaces for uneven glue joints and seams that require filler. Apply filler where needed. Many small dents or scratches in balsa can be repaired by applying a few drops of water or moistening the area with a wet tissue. This will swell the wood so you can sand it when it dries.

❑ 2. Sand the entire model with progressively finer grits of sandpaper, finishing with 320 or 400-grit sandpaper.

❑ 3. Use a large brush, air pressure or a Top Flite Tack Cloth to remove dust from the model.

BALANCE THE AIRPLANE Laterally

❑ 1. Mount your wing.

❑ 2. With the wing level, **carefully** lift the model by the engine propeller shaft and the aft end of the fuselage at the bottom of the fin trailing edge (this may require two people). Do this several times.

❑ 3. If one wing always drops when you lift the model, that side is heavy. Balance the airplane by gluing weight inside the other wing tip. Do this by carving a cavity in the bottom of the balsa wing tip and filling it with the amount of weight required to balance the model laterally. Glue the weight in place with epoxy and cover the rest of the cavity with balsa filler. **An airplane that has been laterally balanced will track better in loops and other maneuvers.**

COVER THE MODEL WITH MONOKOTE

It is assumed that you are an intermediate to advanced modeler, so we won't go into many details on covering techniques, but here are some tips you should consider:

- ❑ 1. **NEVER CUT THE COVERING DIRECTLY ON THE SHEETING.** The Spitfire depends upon the wood sheeting for some of its strength. Modelers who cut through the covering tend to cut into the sheeting and this will weaken the structure.
- ❑ 2. We recommend that you paint the plastic wing fillets after you cover the fuse. This way you can overlap the paint onto the covering to make the transition between the two virtually undetectable.
- ❑ 3. Use a Top Flite® Hot Sock™ to minimize dents in the wood from your covering iron.
- ❑ 4. Some modelers have three irons going at once: one on high heat without a Hot Sock for stretching the covering around curves like wingtips; one on medium heat with a Hot Sock for bonding the covering to large sheeted areas like the wing and stab; and a Trim Iron for small areas.
- ❑ 5. When you cover large sheeted surfaces such as the wing, bond the covering in the middle and work outward, pushing out air as you proceed. Do not move the iron in a circular motion, but move it span-wise with the grain of the wood.
- ❑ 6. When you cover smaller parts with square edges such as the elevators and ailerons, cover the ends first with separate pieces of covering. Then, all you have to do is wrap the covering around the top and bottom and iron it down.
- ❑ 7. When you cover sharp junctions like where the stab meets the fuse, cut narrow strips of covering (3/8 to 1/2" [10 to 15mm] wide) and apply them in the corners **before** you cover the major surfaces.

The larger pieces of covering will overlap the smaller pieces. This technique also eliminates the need to cut the covering after it has been applied.



HOW TO MAKE INVASION STRIPES

Since most of the trim schemes for Spitfires have invasion stripes on both the wing and the fuse, we thought it would be helpful to show you a way to make them.

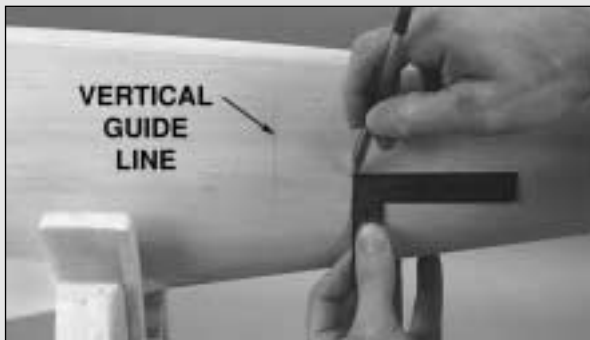
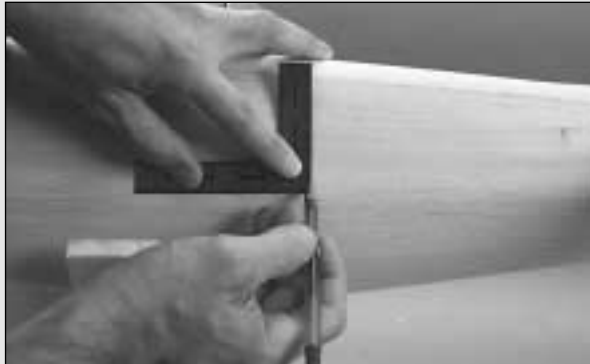

- ❑ 1. Use a small square to lightly mark two vertical **guide lines** on the side of the fuse where you want one of the invasion stripes to go. Use the center stringer to position the square so the lines will be vertical.

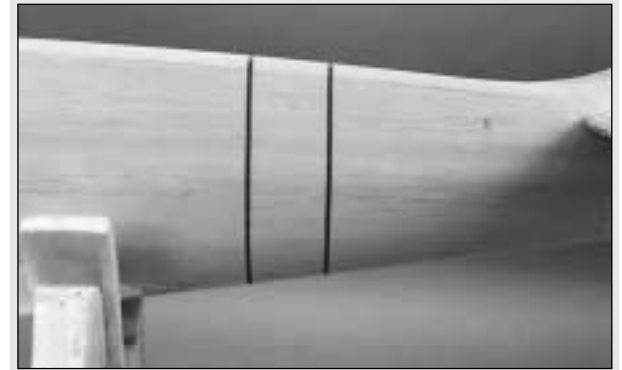

- ❑ 2. Wrap strips of 1/8" [3mm] flexible masking tape around the fuselage using the lines you marked as a guide. You'll have to *eyeball* the strips on the top and the bottom of the fuselage to make sure they are square and parallel. Take your time here and view the fuselage and the masking tape from several different directions. Reposition the masking tape as necessary.

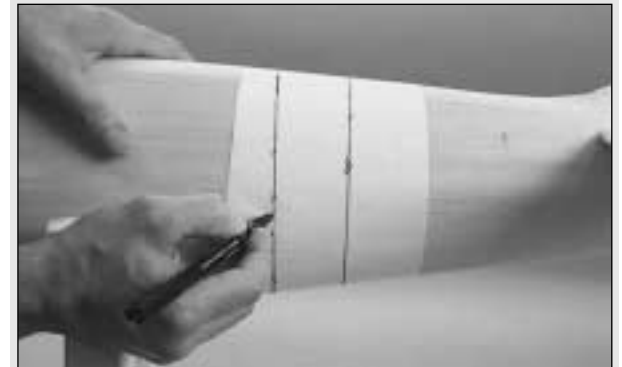

- ❑ 3. Tape a piece of covering to the fuselage over the tape lines. Use the tape to guide your Top Flite Panel Line Pen along the covering, transferring the invasion stripe onto the covering. You can go all the way around the fuselage and make the invasion stripe in one piece, or make it in two halves, separating them on the top and the bottom of the fuse.



☐ 4. Take the covering off the fuse and cut along the lines you marked. Wipe away leftover ink with a tissue dampened with alcohol. There's your invasion stripe!

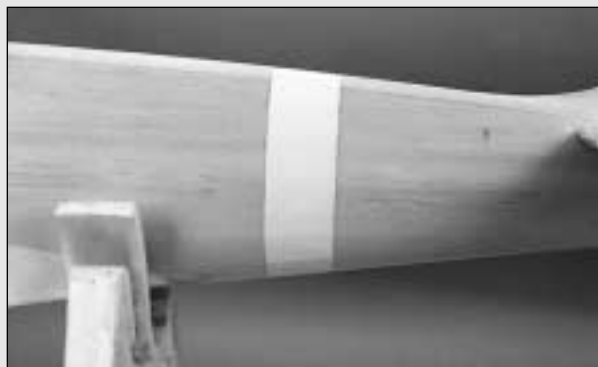

☐ 5. Iron your invasion stripe in place. Make the rest of the invasion stripes the same way. Don't forget to overlap your invasion stripes by approximately 1/8" [3mm] and put the dark ones over the light ones.

COVERING SEQUENCE

FUSELAGE

- ☐ 1. Tail *junction strips* as described previously
- ☐ 2. Stab tops, then bottoms
- ☐ 3. Fin right, then left side
- ☐ 4. Fuse bottom aft, then front
- ☐ 5. Fuse sides
- ☐ 6. Turtle deck (may be done in one or two pieces)
- ☐ 7. Front deck (aft of cowl)

WING

- ☐ 1. Hidden areas and *corners* such the TE in the flap and aileron area
- ☐ 2. Wing fairing where wing blends to the fuse
- ☐ 3. Bottom of one, then the other half of the wing
- ☐ 4. Top of one, then the other half of the wing

CONTROL SURFACES AND DETAILS

- ☐ 1. Ends, bottoms, then tops of elevators and ailerons
- ☐ 2. Ends, then bottom of flaps
- ☐ 3. One, then the other side of the rudder
- ☐ 4. Aileron servo hatches
- ☐ 5. Wheel well covers
- ☐ 6. Radiators

PAINTING

Note: This section does not apply to the canopy. See the *Canopy* section on page 53.



At this stage all of your plastic pieces should have the seams filled with Bondo or putty. If you haven't already done so, wet-sand the plastic parts with 400-grit wet-or-dry sandpaper so the paint will adhere. Spray all the molded plastic parts (except for the canopy) and scale accessories with at least one coat of primer. We used Top Flite LustreKote on all the ABS plastic that needed to be painted. Wet-sand the plastic pieces between coats with 400-grit sandpaper. Use Great Planes 1/8" [3.2mm] EZ-Mask Flexible Masking Tape (GPMR1000) for masking sharp lines, Kyosho Masking Cover Sheet (KYOR1040) for masking large areas. A Top Flite Tack Cloth (TOPR2185) is useful to remove dust just before you paint. LustreKote paint gives a MonoKote matching finish. For the wing fillets, we suggest first covering the fuselage with MonoKote, then painting the fillets to match the MonoKote. You can paint over MonoKote film with LustreKote.

Note: We *brush painted* the exhaust stacks on the cowl with plastic model paint. The cowl was clear coated with LustreKote flat clear so this fuelproofed the exhaust stacks.

For painting the pilots we recommend acrylic water base paints such as the types found in craft stores. Acrylic paint looks great on your pilot because it is not glossy and best of all, it cleans up with water.

JOIN THE CONTROL SURFACES

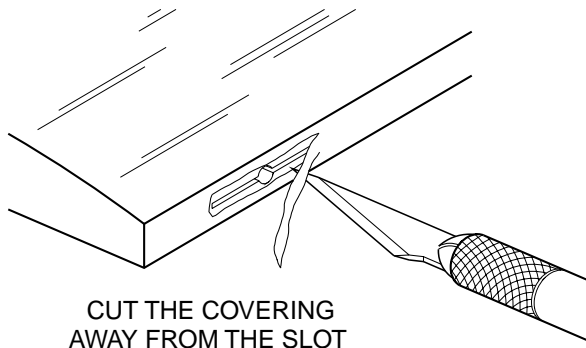

- ❑ 1. Start with the stab and elevators. Remove a small strip of covering from the hinge slots.
- ❑ 2. Fit the hinges in only the stab or elevators (without glue). Fill the torque rod holes in the elevators with 30-minute epoxy. Immediately proceed to the next step.

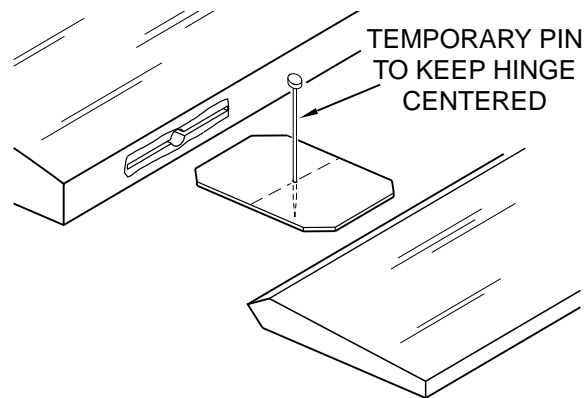

- ❑ 3. Join the elevators to the stab with the hinges, simultaneously installing the joiner wire in the elevators. Wipe away excess epoxy with a tissue dampened with alcohol. If the hinges don't remain centered as you join the elevators to the stab, remove the stab and insert a pin in the center of the hinges to keep them centered. Make sure there is approximately a 1/64" [.5mm] gap between the elevators and the stab so you do not glue them together.

Do not use CA accelerator on any of the hinges and do not glue the hinges with anything but thin CA. Do not attempt to glue one half of the hinge at a time. The hinges will not be properly secured and could come out while the model is in flight.

ASSEMBLE, THEN APPLY 6 DROPS OF THIN CA TO CENTER OF HINGE, ON BOTH SIDES

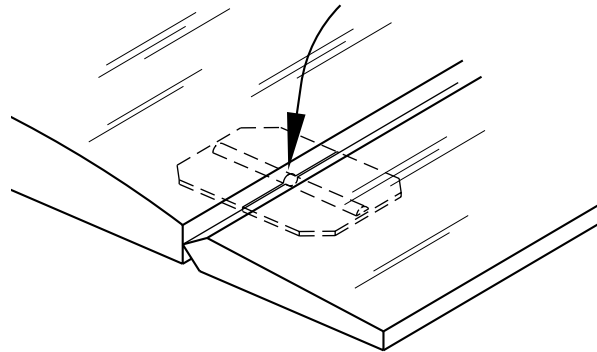

THE CA WICKS ALONG THE "TUNNELS" TO THE ENTIRE HINGE SURFACE

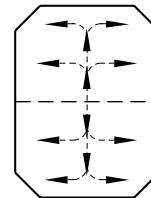

- ❑ 4. Cut a paper towel into 2" [50mm] squares. Add six drops of thin CA to the center of the hinges on **both the top and bottom**. The *tunnels* you drilled will *wick* the CA into the entire hinge surface. Use the paper towel squares to absorb excess CA from the hinge gap before it cures.
- ❑ 5. Use the same hinging method to join the rudder to the fin and the ailerons to the wing.
- ❑ 6. If you've built working flaps, use a toothpick to apply a small amount of petroleum jelly to the pivot points of the hinges to keep epoxy out.

❑ 7. Mix enough 30-minute epoxy to do one flap at a time. Use a piece of wire or a toothpick to thoroughly coat the holes in one of the flaps and the holes in the wing with the epoxy. Coat one side of the flap hinges with epoxy and insert them into the wing. Coat the other side of the hinges with epoxy and join the flap. Wipe away excess epoxy before it cures.

❑ 8. Position the flap and the hinges so the flap is centered and fits the wing. Tape the flap in place until the epoxy has fully cured.

❑ 9. Join the other flap to the wing the same way.

❑ 10. Reinstall the pushrods you disconnected before covering and mount the control horns to the ailerons, flaps, elevator and rudder. Reinstall any hardware and other components you may not already have in place such as the fuel tank and fuel lines, servos, on/off switch, air tank, engine, muffler, fuel filler valve, air filler valve, etc.

SCALE DETAILS

❑ 1. If you will not be installing the Top Flite Spitfire Scale Cockpit Interior kit, add whatever scale details you like to the cockpit. Use leftover balsa or thin cardboard (from a cereal box) to make an instrument panel, seat back, seat, etc.

❑ 2. Glue your pilot in place. We trimmed the shoulders from a Williams Brothers 1/6-scale Standard pilot and glued him directly to the scale cockpit sides.

CANOPY

CAUTION: LustreKote will deform clear butyrate plastics when painting large areas. If unsure, test the paint on a leftover piece of plastic. Butyrate plastic will curl after a few days.



❑ 1. Mask the canopy for painting with wide masking tape (or several standard size strips of masking tape). Apply the masking tape, then use the frame as a guide to simultaneously press the masking tape down while you draw a guide line around the edge with a pencil.



❑ 2. Cut the masking tape from the canopy frame along the guideline you drew. Remove excess tape. Do one section at a time until the canopy is completely masked-off and ready to paint. Mask the inside of the canopy to protect it from overspray.

❑ 3. Spray paint the canopy frame with fuelproof paint. Make sure the paint will not react with the plastic. Test on leftover pieces if unsure. We used Pactra Formula-U Olive Drab to paint the canopy of our Prototype Spitfire. It's a close match to MonoKote film. LustreKote is **not** recommended for painting butyrate.



❑ 4. Position the canopy on the fuselage and draw its outline on the fuselage with a felt tip pen. Poke holes through the covering with pin inside the line or remove a thin strip of covering just inside the outline. Wipe away the ink with a cloth dampened with alcohol.



❑ 5. Glue the canopy in place with special canopy glue such as J & Z Products' Z RC/56 canopy glue (JOZR5007). Hold the canopy in place with tape or rubber bands. Use a balsa stick under the rubber bands to hold the sides of the canopy to the fuselage. Wipe away excess glue with a tissue

dampened with water before the glue dries. Make sure there is no glue on the balsa sticks so you do not inadvertently glue the balsa sticks to the canopy.

PROPELLER AND SPINNER

There are two methods to make a scale, static display propeller for your Spitfire. For our prototype Spitfire we modified the Top Flite P-51 Static Display Prop (TOPQ7906). This is only recommended for those who have **access to a belt sander** because there is much plastic to sand off. Here's how to do it:

REMOVE THIS PORTION OF THE PROPELLER HUB

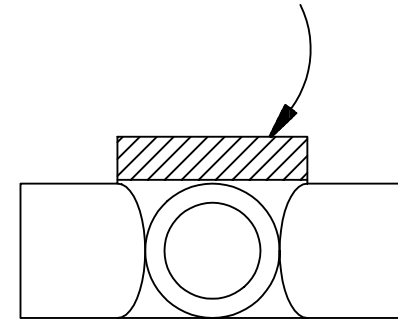

❑ 1. Trim the propeller hub of the P-51 display prop as shown in the sketch.



❑ 2. Use the **Spitfire display prop template** provided on the plan to mark the correct outline on each of the four P-51 blades.

Hint: Lightly spray the back of the template with 3M 75 Repositionable Spray Adhesive to hold it to the blade while you *scribe* the outline with a hobby knife or something similar.

- ❑ 3. Use a belt sander or a rotary tool with a sanding drum to trim the propellers along the lines you marked to arrive at the correct outline.

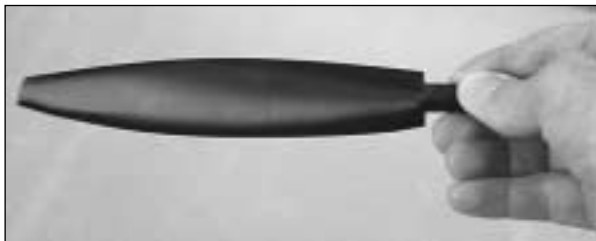

- ❑ 4. Sand the blades to a uniform contour, rounding the leading and trailing edges. Sand off the *boot* portion of the blades as well.



- ❑ 5. Cut holes in your spinner to accommodate the *pegs* of the propeller blades. Start with a drill or a carbide cutter on your rotary tool and finish with a sanding drum.

Hint: You'll notice that the hole in the middle of the spinner at the front (for the bolt that holds it on) has been filled. You can do this with your display spinner because it is not for flying and the propeller blades will hold the spinner on.

- ❑ 6. Mount the backplate of your spinner to your engine. Install the propeller hub and test fit the blades. Make adjustments where necessary.

- ❑ 7. Wet sand your propeller blades with progressively finer grades of sandpaper. Prime, then paint the tips yellow. Finish with a coat of flat clear paint over the entire blade to blend it all together. You don't have to use fuelproof paint because this propeller is for display only. Paint your spinner to match your trim scheme.

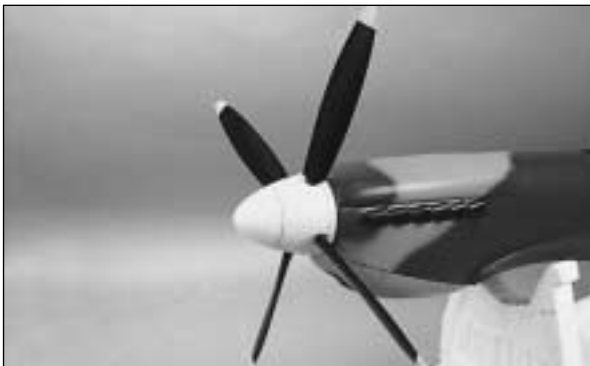

- ❑ Here's how it should look when your model's all done...just like a Spitfire propeller and spinner!

Another method for making a static display propeller is to join two wood propellers. This may be more practical for some modelers because wood propellers are easier to carve, sand and shape than plastic propellers. Use propellers with a diameter of approximately 18" to 19" [460 to 480mm]. *Notch* the back of one propeller and the front of the other propeller and glue them together. Use the **Spitfire display prop template** provided on the plan to mark the outline on each of the four blades. Trim the blades to the correct shape and trim your spinner to accommodate the propeller. Prime, then paint to match your trim scheme.

GUNS AND ANTENNA MAST

Your guns can be made removable or permanent. On our prototype we made the guns removable so there would be less chance of breaking them off during transportation. You can make the guns before or after you cover the wing.

- ❑ 1. Use a 9/32" [7.1mm] brass tube sharpened at one end to cut a hole in the center of the leading

edge of the wing in the location of the gun. Cut the brass tube to a length of 1-1/4" [32mm] and glue it into the wing in the hole you just made (see the following photo).

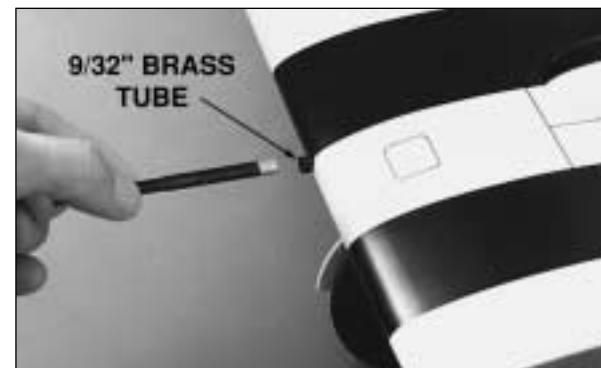

- ❑ 2. Make the other part of the gun (the removable part) from a 1/4" [6.4mm] brass tube and a wood dowel. Shape the dowel to resemble a gun barrel, then glue it inside the 1/4" [6.4mm] brass tube. This will fit inside the 9/32" [7.1mm] brass tube you glued in the wing. After you paint the removable portion of the gun it should fit securely into the tube in the wing and stay in place during flight. If not, roughen the gun with coarse sandpaper or apply a thin coat of CA to provide enough friction to keep it in place.

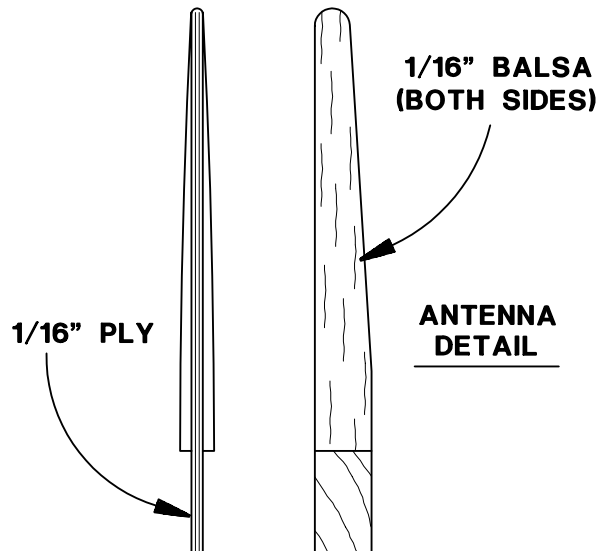

3. Make the **antenna mast** from a piece of leftover 1/16" [1.6mm] plywood sandwiched between two pieces of leftover 1/16" [1.6mm] balsa. Sand to an airfoil shape, then paint or cover to match the rest of your model.

4. Cut a notch in the top of the fuselage where shown on the plan to insert the antenna. Like the guns, you can permanently glue the antenna mast in place or just leave it removable for transporting your model.

WHEEL COVERS

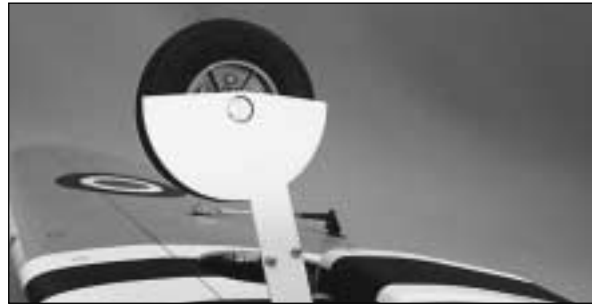

The **wheel covers** shown on the model on the cover of the box are intended for display, but could be left in place for flying if you enlarge the opening in the bottom of the wing to accommodate the covers when the wheels are retracted. Use the template provided on the plan to cut them from 1/8" [3.2mm] plywood. To fit the wheel covers to your landing gear struts you will need two landing gear straps (GPMQ4254) and four 4-40 x 1/4" [6.4mm] screws. Paint or cover the wheel covers to match your trim scheme, then mount them to your landing gear with the straps and screws.

RADIATORS



Place the finished radiators on the bottom of your wing and position them so they will not interfere with the flaps or landing gear. Trace their outline onto the wing with a felt tip pen. Use a small pin to poke holes through the covering inside the lines and wipe away residual ink with a cloth dampened with alcohol. Glue the radiators in place with thin or medium CA.

MACHINE GUN COVERS

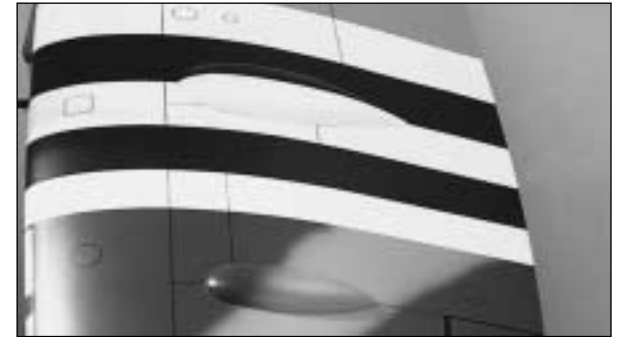

Position the finished machine gun blisters on the wing where shown on the plan. The same as you did the radiators, trace their outline onto the wing with a felt tip pen and poke holes in the covering inside the outline with a pin. Wipe away the ink with a cloth dampened with alcohol, then glue the machine gun covers in place with thin or medium CA.

PANEL LINES

No warbird is complete without panel lines. Panel lines really *finish* the job and set your model apart from others (besides, they tend to distract the eye from any building imperfections and uneven surfaces—not that **your** model has any!). Study the photos and documentation you have gathered and decide which panel lines to add. There are two methods for adding panel lines. The first is to use a Top Flite **Panel Line Pen** (TOPQ2510) with a flexible straightedge. Apply a few strips of masking tape to the back of your straightedge about 1/8" [3mm] from the edge to raise it off the surface so the ink won't *bleed* underneath. Place the straightedge directly on your model and use it as a guide to mark your panel lines. Use the Top Flite **Scale Template** (TOPR2187) for rivets, hatches, fuel caps and other details. Some cleaners will remove the ink lines, so test your cleaner on the ink before you spray it on your model. We sealed our panel lines by spraying our entire model with a coat of LustreKote flat clear.

The second method for applying panel lines is to use a Top Flite **Smart Stripe™** to cut narrow strips of MonoKote film. Iron the panel lines in position. Black or Charcoal MonoKote film is recommended.

DECALS

1. Study the plans and the photos on the box to decide where to place the decals.
2. Thoroughly clean your airplane before applying decals.
3. Trim the decals as close as practical and carefully apply them to your model. You can *float* the decals into position by first applying soapy water to the model's surface (just a teaspoon of dish detergent to a quart of water), then *squeegeeing out* the water and soap with a piece of soft balsa or a credit card wrapped with a tissue. Blot the surface dry and let the decal cure for at least 12 hours before running the engine.

GET YOUR MODEL READY TO FLY

BALANCE YOUR MODEL

NOTE: This section is VERY important and must NOT be omitted! A model that is not properly balanced will be unstable and possibly unflyable.

1. See the **Expert Tip** that follows to accurately mark the balance point on the **top** of the wing on both sides of the fuselage. The balance point is shown on the plan (**CG**) and is located **4-1/8" (104.7mm) back from the leading edge at the wing root** as shown in the sketch and on the plans. This is the balance point at which your model should be balanced for your first flights. Later, you

may experiment by shifting the balance up to 1/4" [6.4mm] forward or 9/32" [7.1mm] back to change the flying characteristics. If you move the balance point **forward** it may improve the smoothness and tracking, but your Spitfire may then require more speed for takeoff and become more difficult to slow for landing. If you move the balance **aft** it may make your Spitfire more agile with a lighter *feel* and allow you to slow the model more for landing. In any case, **please start at the location we recommend and do not at any time balance your model outside the recommended range.**

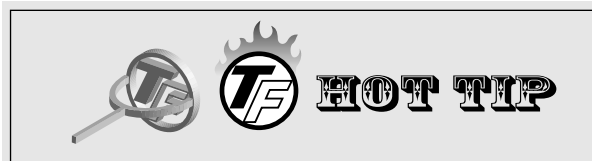

How to mark the balance point.

The balance point is measured from the **center leading edge**. Mark the balance point outward a few inches so you can see where to lift the wing when it's bolted to the fuse. To do this, mark the balance point with a felt tip pen or tape on **both ends** of the center section. Place a straightedge across the marks. Mark the balance point along the straightedge further out on the wing. Mount the wing to the fuselage.

2. Temporarily place your receiver and battery pack inside the fuselage where you plan to mount them. This is so you can change their location if necessary to arrive at the correct C.G. without adding any additional nose or tail weight. All other components should be in the model and it should be in a ready-to-fly condition, but with an empty fuel tank.

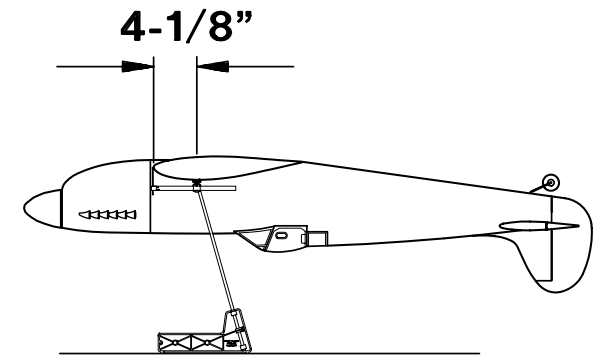

3. With the wing attached to the fuselage, the landing gear retracted (if you have retracts) and an **empty** fuel tank, lift the model at the balance point. We use the Great Planes C.G. Machine™ (shown in the sketch). If the tail drops, the model is tail heavy and you must shift your battery pack or other components forward or add weight to the nose. If the nose drops, it is nose heavy and you must shift your battery pack or other components aft or add weight to the tail. In order to save weight, relocate your battery pack and/or receiver or other components before you add additional weight to arrive at the correct C.G. You may install nose weight by using a spinner weight or gluing lead weights to the firewall. You may add tail weight by sticking Great Planes (GPMQ4485) stick-on lead weights on the bottom of the fuselage under the tail. Later, if the balance proves to be OK, you can open the fuse bottom and glue these permanently in position. We don't recommend sticking weights to the cowl because it is not designed to support weight.

FINAL HOOKUPS AND CHECKS

Perform this step only if you have not installed retracts.

1. Mount the main landing gear wires in the wing with the nylon landing gear straps and #2 x 1/2" [12.7mm] screws included with this kit. Mount

your wheels to the landing gear with a 3/16" [4.8mm] wheel collar on both sides of both wheels. Secure the wheel collars with a drop of thread lock on the set screws.

Note: We recommend you file a small flat spot on the landing gear wire where the set screws are located.

Skip to step 5.

❑ 2. Use a small file or a rotary tool with a cut-off wheel to grind small flat spots on the main landing gear wires so the set screws in the retracts will securely lock the wires in position. Adjust the flat spots until you can achieve the alignment detailed earlier in the manual when you were first installing the landing gear. File flat spots on the ends of the wires for the set screws of the axles and on the axles for the set screws of the wheel collars.

❑ 3. Securely fasten the axles to the landing gear wires. Use a drop of thread lock on the set screws or, for the most security, silver solder the axles to the main gear with the set screws in place.

❑ 4. Securely mount the landing gear to the retracts using a small drop of thread lock on the set screws. Mount the wheels to the axles with wheel collars and, you guessed it, a small drop of thread lock (if you don't thread lock the set screws, you **will** lose a wheel!).

❑ 5. Mount a 1-1/4" [32mm] tail wheel on the tail gear wire and secure it with a 3/32" [2.4mm] wheel collar and a drop of thread lock.

❑ 6. If you haven't already done so, route your air lines and servo connectors in the wing and in the fuse. Connect the servos in the fuselage to the receiver and plug in servo extension cords for the aileron and flap servo. Make sure no wires or air lines interfere with any of the servo arms, pushrods, etc.

❑ 7. Take the servo arms off your servos, turn on your transmitter and center all the trims. Reinstall all the servo arms and secure them with the screws.

❑ 8. Double-check all the servos and make sure the servo arms are secure and all the clevises have a **silicone retainer**.

❑ 9. Make sure the control surfaces move in the proper direction as illustrated in the following sketch.

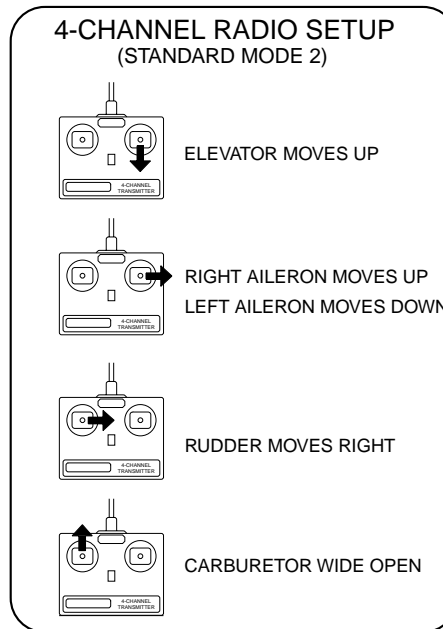

❑ 10. Adjust your pushrod hookups and set up your radio to provide the control surface

movements as follows. Use a ruler or a Great Planes AccuThrow™ Control Surface Deflection Meter (GPMR2405) to measure the throws.

CONTROL SURFACE THROWS			
		High rate	Low rate
Elevator		5/8" up	1/2" up
		5/8" down	1/2" down
Rudder		1-1/8" left	7/8" left
		1-1/8" right	7/8" right
Ailerons		3/4" up	1/2" up
		5/8" down	3/8" down
Flaps	Landing		
	position #1	1/2"	position #2 1-1/4"

The balance point and control surface throws listed in this manual are the ones at which the Spitfire flies best. Set up your aircraft to those specifications. If, after a few flights, you would like to adjust the throws or C.G. to suit your tastes, that is fine. Too much control surface throw can make your model difficult to control or force it into a stall, so remember...More is not better.

TRIM MIXING: If your transmitter has Elevator to Retract mixing, we recommend mixing 1/16" [1.6mm] of **down** elevator when the gear is retracted. This will keep the nose level when the gear is cycled.

PREFLIGHT

IDENTIFY YOUR MODEL

No matter if you fly at an AMA sanctioned R/C club site or if you fly somewhere on your own, you should always have your name, address, telephone number and AMA number on or inside your model. It is **required** at all AMA R/C club flying sites and AMA sanctioned flying events. Fill out the identification sticker included with this kit and place it on or inside your model.

CHARGE YOUR BATTERIES

Follow the battery charging procedures in your radio instruction manual. You should **always** charge your transmitter and receiver batteries the night before you go flying and at other times as recommended by the radio manufacturer.

BALANCE YOUR PROPELLERS

Carefully balance your propellers before you fly. An unbalanced prop is the single most significant cause of vibration that can damage your model. Not only will engine mounting screws and bolts loosen, possibly with disastrous effect, but vibration may also damage your radio receiver and battery. Vibration can also cause your fuel to foam, which will, in turn, cause your engine to run hot or quit.

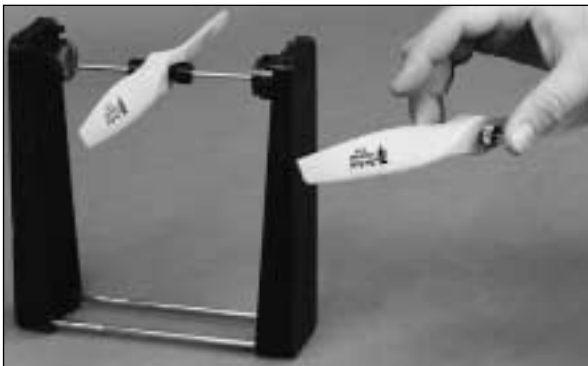

We use a Top Flite Precision Magnetic Prop Balancer™ (TOPQ5700) in the workshop and keep a Great Planes Fingertip Prop Balancer (GPMQ5000) in our flight box.

FIND A SAFE PLACE TO FLY

The best place to fly your model is an AMA chartered R/C club flying field. Contact the AMA (their address is on page 2) or your hobby shop dealer for the club in your area and join it. Club fields are intended for R/C flying, making your outing safer and more enjoyable. The AMA also provides insurance in case of a flying accident. If an R/C flying field is not available, find a large, grassy area at least six miles from buildings, streets and other R/C activities. A schoolyard is usually not an acceptable area because of people, power lines and possible radio interference.

GROUND CHECK YOUR MODEL

If you are not thoroughly familiar with the operation of R/C models, ask an experienced modeler to inspect your radio installation and control surface set-up. **Follow the engine manufacturer's instructions to break-in your engine.** After you run the engine on your model, inspect your model closely to make sure all screws remain tight and your pushrods and connectors are secure.

RANGE CHECK YOUR RADIO

Ground check the range of your radio before the first flight of the day. With the transmitter antenna collapsed and the receiver and transmitter on, you should be able to walk at least 100 feet away from the model and still have control. Have an assistant stand by your model and, while you work the controls, tell you what the control surfaces are doing.

Repeat this test **with the engine running** at various speeds with an assistant holding the model, using hand signals to show you what is happening. If the control surfaces do not respond correctly, **do not fly!** Find and correct the problem first. Look for loose servo connections or broken wires, corroded wires on old servo connectors, poor solder joints in your battery pack or a defective cell in your battery pack, or a damaged receiver crystal from a previous crash.

CHECK LIST

During the last few moments of preparation your mind may be elsewhere anticipating the excitement of your first flight. Because of this, you may be more likely to overlook certain checks and procedures you save until your model is almost done. To help you avoid this, we've provided a checklist to make sure you don't overlook these important areas. Many are covered in the instruction manual so, where appropriate, refer to the manual for complete instructions. Be sure to check the items off as you complete them (that's why we call it a check list!).

- 1. Fuelproof all areas exposed to fuel or exhaust residue such as the firewall/engine compartment, fuel tank compartment, wing saddle area, trailing edge of the wing and the flap area and wheel wells (if your model has flaps and retracts), etc.

- 2. Verify the C.G.
- 3. Secure the battery and receiver with a strip of balsa or plywood. Simply stuffing them into place with foam rubber is not sufficient.
- 4. Extend your receiver antenna and make sure it has a strain relief inside the fuselage to keep tension off the solder joint inside the receiver.
- 5. Balance your model laterally as explained in the instructions.
- 6. File flat spots on landing gear wires and axles for the set screws to lock onto.
- 7. Secure critical fasteners with thread locking compound (the screws that hold the carburetor arm, set screws on wheel collars and slip-on type axles, screw-lock pushrod connectors, etc.).
- 8. Add a drop of oil to the axles so the wheels will turn freely.
- 9. Make sure all hinges are securely glued in place.
- 10. Reinforce holes for wood screws with thin CA where appropriate (control horns, servo hatches, etc.).
- 11. Confirm that all controls operate in the correct direction and the throws are set up according to the manual.
- 12. Make sure there are silicone retainers on all the clevises.
- 13. Fasten all servo arms to the servos with the screws included with your radio.

- 14. Use vinyl tape or heat shrink tubing to secure the plugs that connect your servo wires to Y-connectors or servo extensions. Also secure the plug that connects your battery pack to the on/off switch.
- 15. Make sure any servo extension cords you may have used do not interfere with other systems (servo arms, landing gear, pushrods, etc.).
- 16. Secure the pressure tap to the muffler with high temp RTV silicone, thread locking compound or J.B. Weld.
- 17. Use nylon ties on both ends of the silicone tube connecting the muffler to the header.
- 18. Make sure your fuel lines and pressure lines are connected and are not kinked.
- 19. Use an incidence meter to check the wing for twists and attempt to correct before flying.
- 20. Balance your propeller (and spare propellers).
- 21. Tighten the propeller nut and spinner.
- 22. Place your name, address, AMA number and telephone number on or inside your model.
- 23. Cycle your receiver battery pack (if necessary) and make sure it is fully charged.
- 24. If you wish to photograph your model, do this before your first flight.
- 25. Range check your radio when you get to the flying field.

ENGINE SAFETY PRECAUTIONS

NOTE: Failure to follow these safety precautions may result in severe injury to yourself and others.

Store model fuel in a safe place away from high heat, sparks or flames. Do not smoke near the engine or fuel as it is very flammable. Engine exhaust gives off a great deal of deadly carbon monoxide so **do not run the engine in a closed room or garage.**

Get help from an experienced pilot when you learn to operate engines.

Use safety glasses when you operate model engines.

Do not run the engine near loose gravel or sand; the propeller may throw loose material in your face or eyes.

When you start and run the engine, keep your face and body as well as all spectators away from the plane of rotation of the propeller.

Always be **aware** and very **conscious** of hand movements and be **deliberate** in your reach for the needle valve, glow plug clip, or other items near a spinning propeller.

Keep loose clothing, shirt sleeves, ties, scarfs, long hair or loose objects away from the prop. Be conscious of pencils, screw drivers or other objects that may fall out of your shirt pockets.

Use a *chicken stick* or electric starter and follow the instructions to start your engine.

Make certain the glow plug clip or connector is secure so that it will not pop off or get into the running propeller.

Ask an assistant to hold the model from the rear while you start the engine and operate the controls.

Make all engine adjustments from **behind** the rotating propeller.

The engine gets hot! Do not touch the engine during or immediately after you operate it. Make sure fuel lines are in good condition so fuel will not leak onto a hot engine and cause a fire.

To stop the engine, close the carburetor barrel (rotor) or pinch the fuel line to discontinue the fuel flow. Do not use your hands, fingers or any body part to stop the engine. Never throw anything into the prop of a running engine.

AMA SAFETY CODE (excerpts)

Read and abide by the following Academy of Model Aeronautics Official Safety Code:

GENERAL

1. I will not fly my model aircraft in sanctioned events, air shows, or model flying demonstrations until it has been proven to be airworthy by having been previously successfully flight tested.

2. I will not fly my model aircraft higher than approximately 400 feet within 3 miles of an airport without notifying the airport operator. I will give right of way to and avoid flying in the proximity of full scale aircraft. Where necessary an observer shall be used to supervise flying to avoid having models fly in the proximity of full scale aircraft.

3. Where established, I will abide by the safety rules for the flying site I use and I will not willfully and deliberately fly my models in a careless, reckless and/or dangerous manner.

7. I will not fly my model unless it is identified with my name and address or AMA number, on or in the model.

9. I will not operate models with pyrotechnics (any device that explodes, burns, or propels a projectile of any kind).

RADIO CONTROL

1. I will have completed a successful radio equipment ground check before the first flight of a new or repaired model.

2. I will not fly my model aircraft in the presence of spectators until I become a qualified flier, unless assisted by an experienced helper.

3. I will perform my initial turn after takeoff away from the pit or spectator areas and I will not thereafter fly over pit or spectator areas, unless beyond my control.

4. I will operate my model using only radio control frequencies currently allowed by the Federal Communications Commission...

FLYING

The Top Flite Spitfire is a great flying sport scale airplane that flies smoothly, yet is highly maneuverable. Compared to other warbirds, its flight characteristics are very smooth and forgiving. It does not, however, have the self-recovery characteristics of a primary R/C trainer; therefore, you must either have mastered the basics of R/C flying or obtained the assistance of a competent R/C pilot to help you with your first flights.

Fuel mixture adjustment

A fully cowled engine may run at a higher temperature than an uncowed engine. For this reason, the fuel mixture should be richened so the engine runs at about 200 rpm below peak. By running the engine slightly rich, you will help prevent dead stick landings caused by overheating.

TAKEOFF

If you have dual rates on your transmitter, set the switches to “high rate” for takeoff, especially when taking off in a crosswind. We recommend that you **do not** use flaps during take off. Although this model has excellent low speed characteristics, you should always build up as much speed as your runway will permit before lifting off, to give you a safety margin in case of a “flame-out.” When you first advance the throttle and the tail begins to lift, the plane will start to turn left (a characteristic of all “tail draggers”). Be ready for this and correct by applying a slight amount of right rudder to steer it straight down the runway. Be sure to allow the tail to come up. Don’t hold the tail on the ground with too much up elevator, as the Spitfire will become airborne prematurely and will possibly stall. When the plane has sufficient flying speed, lift off by smoothly applying up elevator (don’t “jerk” it off into a steep climb!) and climb out gradually.

FLIGHT

We recommend that you take it easy with your Spitfire for the first several flights, gradually “getting acquainted” with this warbird as your engine gets fully broken-in. Add and practice one maneuver at a time, learning how she behaves in each. For ultra-smooth flying and normal maneuvers, we recommend using the “low rate” settings as listed on page 57. “High rate” elevator may be required for crisp snap rolls and spins. “High rate” rudder is best for knife edge. **Speed** is the key to good knife-edge performance.

Caution (THIS APPLIES TO ALL R/C AIRPLANES): If, while flying, you notice any unusual sounds, such as a low-pitched “buzz”, this may indicate control surface “flutter”. Because flutter can quickly destroy components or your airplane, any time you detect flutter you must immediately cut the throttle and land the airplane! Check all servo grommets for deterioration (this may indicate which surface fluttered) and make sure all pushrod linkages are slop-free. If it fluttered once, it will probably flutter again under similar circumstances unless you can eliminate the slop or flexing in the linkages. Here are some things which can result in flutter: Excessive hinge gap; Not mounting control horns solidly; Sloppy fit of clevis pin in horn; elasticity present in flexible plastic pushrods; Side-play of pushrod in guide tube caused by tight bends; Sloppy fit of control rods in servo horns; Insufficient glue used when gluing in torque rods; Excessive flexing of aileron, caused by using too soft balsa; Excessive “play” or “backlash” in servo gears; and insecure servo mounting.

LANDING

When it's time to land, fly a normal landing pattern and approach. You will probably find that the Spitfire retains its airspeed quite well. Due to its small frontal area and efficient shape, the Spitfire's split flaps will really come into play here. For your first landings, plan to land slightly faster than stall speed and on the main wheels, as this is the easiest way to land your Spitfire. Later, with a little technique, you will find you can make moderately slow, 3-point landings.

FLAPS

If you have flaps, lower them on the downwind leg of your approach. Full flaps make the Spitfire very steady in the landing pattern. Just carry a little extra power to make up for the extra drag. The extra drag of the flaps also allows you to make shorter, steeper approaches. Touch-and-go's and go-arounds can be accomplished with the flaps deployed, but be ready to use a little more up elevator. It is preferred to have the flaps raised for takeoffs and climb outs because the plane will accelerate and climb better. If you have to go around and your flaps are lowered, it is better to gain some altitude and airspeed before raising the flaps.

Have a ball! But always stay in control and fly in a safe manner.

GOOD LUCK AND GREAT FLYING!

If you enjoyed building the Top Flite Spitfire, check out the other outstanding .60 size Gold Edition kits shown on pages 62 and 63.

UPPER FUSE SKIN PATTERN

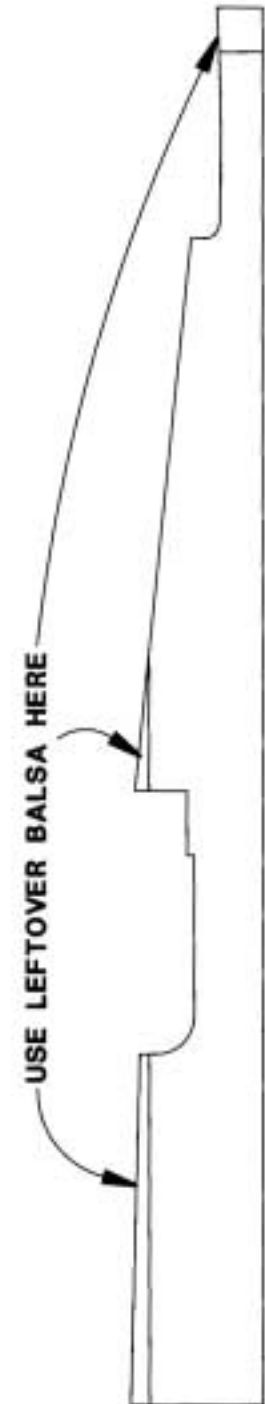



(TOPA0100) Top Flite F4U Corsair
62" [1575mm] Wingspan, 7–9.5 lb [3170 - 4310g]



(TOPA0120) Top Flite P-40E Warhawk
64" [1626mm] Wingspan, 8–10.5 lb [3630 - 4760g]



(TOPA0135) Top Flite P-47D Thunderbolt
63" [1600mm] Wingspan, 8.5-10.5 lb [3860 - 4760g]



(TOPA0110) Top Flite P-51D Mustang
65" [1651mm] Wingspan, 8–10 lb [3630 - 4540g]



(TOPA0130) Top Flite AT-6 Texan
69" [1753mm] Wingspan, 7.5-10 lb [3400 - 4540g]



(TOPA0300) Top Flite Cessna 182 Skylane
81" [2057mm] Wingspan, 10-12 lb [4540 - 5440g]



(TOPA0305) Top Flite Beechcraft Bonanza
81" [2057mm] Wingspan, 11-13 lb [4990 - 5900g]



(TOPA0400) Top Flite Giant Scale P-51D Mustang
84.5" [2146mm] Wingspan, 17.5-19 lb [7938 - 8618g]

2-VIEW DRAWING

Use this layout for trim scheme planning only. Not suitable for scale documentation.

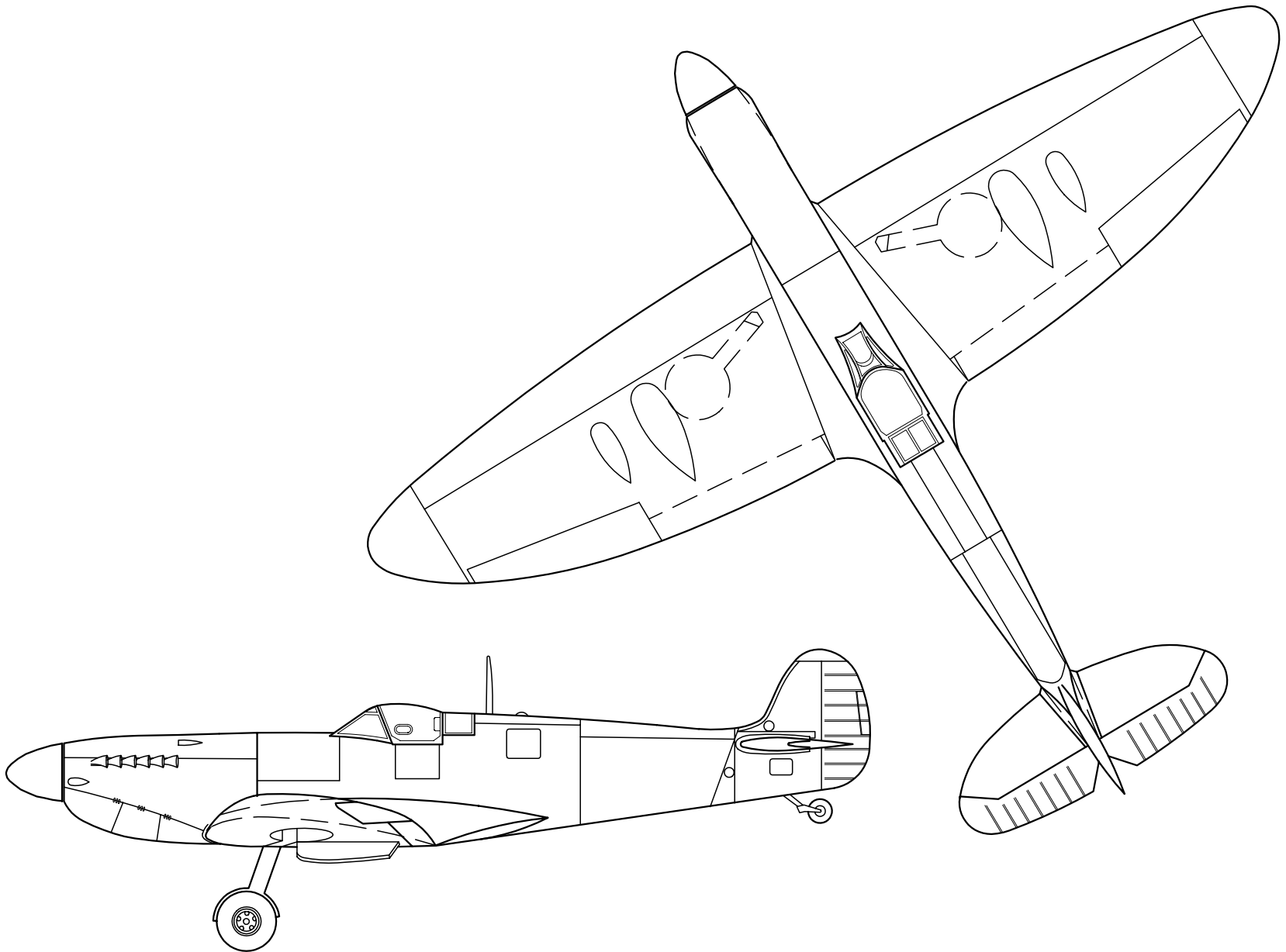

Congratulations for deciding to install a fully detailed, scale looking interior in your Top Flite Spitfire. This is a project that can be as detailed or as straight forward as you care to make it — the choice is yours. We have provided the basic kit that can be assembled and painted in a few hours. It represents a Spitfire Mk IX interior as delivered from the factory. By using this kit, some imagination and your modeling experience, you can create a great looking interior that will “wow” them at the flying field.

PARTS LIST

- 1 Side panel - left
- 1 Side panel - right
- 1 Instrument panel
- 1 Floor
- 1 Aft bulkhead
- 1 Front half control stick
- 1 Rear half control stick
- 1 Seat
- 1 Instruction sheet
- 1 Instrument panel decal
- 1 1/4" x 18" black elastic - seat belts
- 5 Small round head pins - control knobs

TOOLS AND SUPPLIES

- Thin CA (Great Planes® Pro™ CA recommended)
- Hobby knife and #11 blades
- Scissors or Lexan® shears
- Round file
- 220 and 400-grit wet or dry sandpaper
- Sanding block (Great Planes® Easy Touch™ Bar Sander recommended – #GPMR6170)
- Selection of small paint brushes
- Model Enamel paint – (Testors Enamel recommended)
- Needle nose pliers
- Tweezers

ASSEMBLY

1. Cut each of the plastic parts from the master sheets. Be sure to leave the raised edges around each piece as they add stiffness and depth to the parts. Lightly sand the edges smooth.
2. Test fit the parts into your model, trimming and sanding as necessary to obtain a good fit.
3. Wash all of the parts with warm soapy water. Rinse and dry them thoroughly before painting.

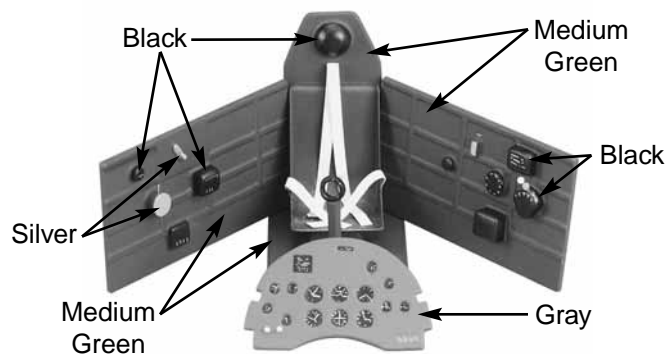

4. Paint all parts with flat enamel model paint following the suggestions on the photos.
5. Trim the decals to fit the instrument faces and placards. Apply them to the painted parts. A sharp hobby knife and tweezers work well for this purpose. Be sure to burnish the decals down so they “stay put.” **NOTE:** The instrument panel portion of the decal is arranged to match the plastic part, so as you cut each instrument, adhere it to the corresponding spot on the panel. For added realism you could also cut holes through the plastic instrument panel. Then, install the decals as a single piece from the back surface.
6. Glue the painted seat to the top of the spacer on the floor.
7. Join the two halves of the control stick together. Glue a “tab” made from a sliver of scrap plastic into the bottom of the control stick. Cut a small slit through the floor to fit the control stick “tab.” Glue the painted control stick into the floor, ahead of the seat.
8. Cut the pins to about 1/2" long. Insert them into the throttle quadrant where desired. Glue the pins in position from behind the throttle quadrant.
9. Test fit the pilot in position and add the seat belts by gluing them to the seat bottom. Cut a 1/4" slit through the seat back above your pilot’s shoulders. Fold the elastic for the shoulder harness in half. Insert the elastic fold through the slit and then glue the elastic to the back of the seat. After installing the cockpit into the model, use silicone adhesive to secure your pilot in position. Attach the seatbelts by gluing or pinning them in place.
10. Glue the finished parts into your model with 6-minute epoxy or silicone adhesive.

When you take your Spitfire to the field, try to be gracious in accepting all the praise you will undoubtedly get. Happy flying!

If you have questions or comments write or call:

Top Flite Models
P.O. Box 788
Urbana, IL 61801

(217) 398-8970