

K28_{b.23} K11_{b.2} K12_{b.10x20 + 10x14} K23,K24_{b.2} K6+K11_{b.2} K5_{b.3} K4_{b.3} K3_{b.3} K2_{b.5A} K1_{b.10}

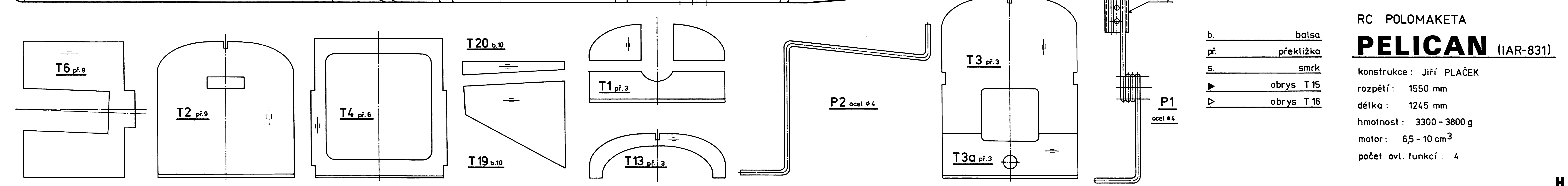
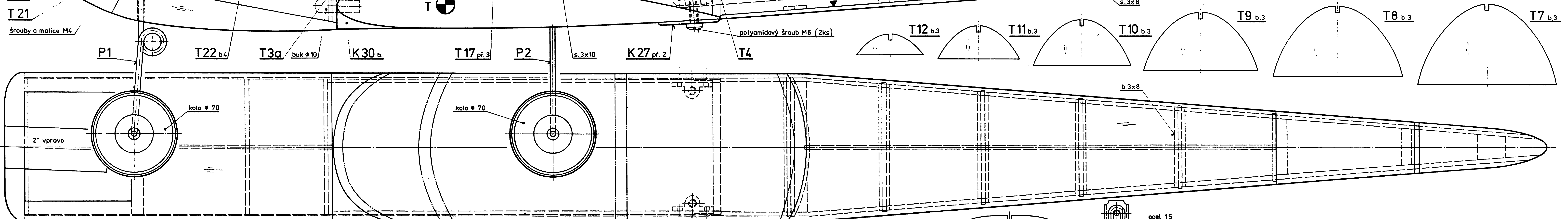
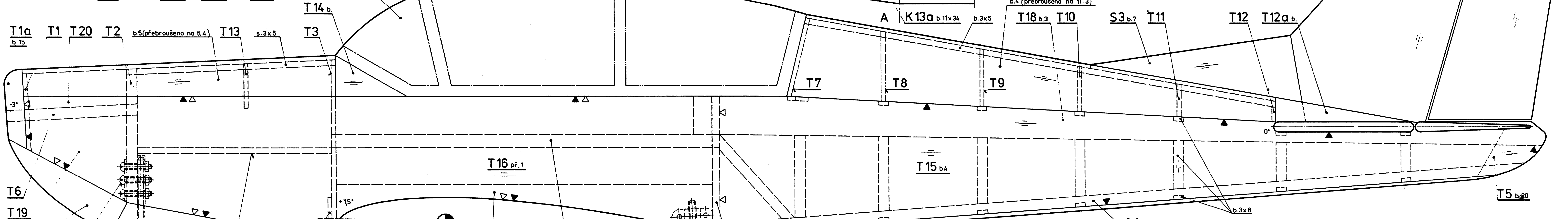
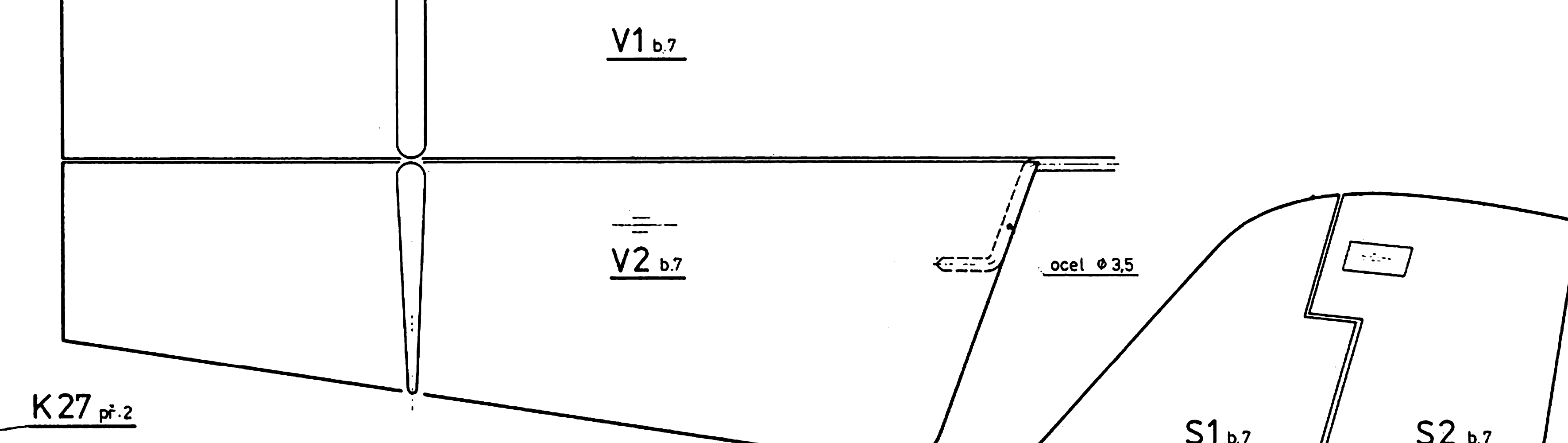
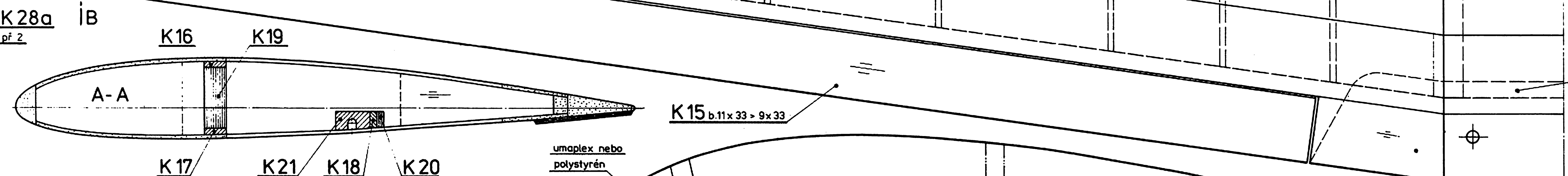
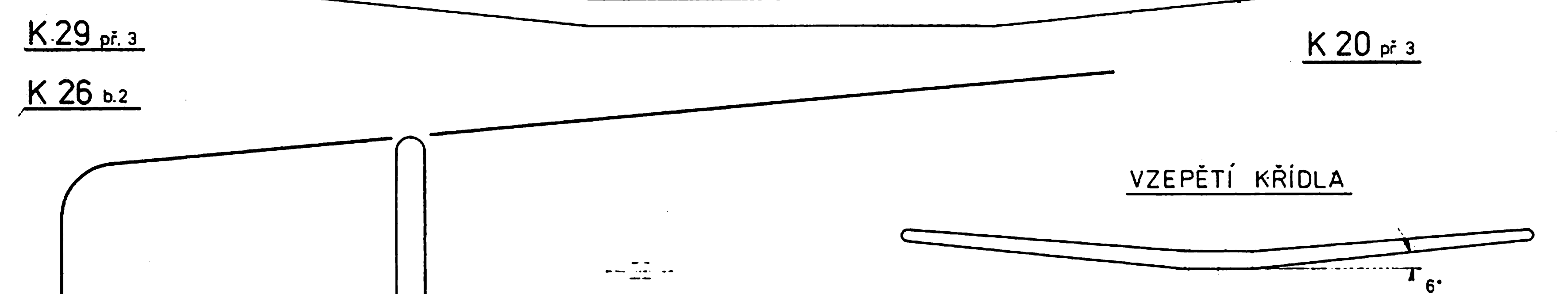
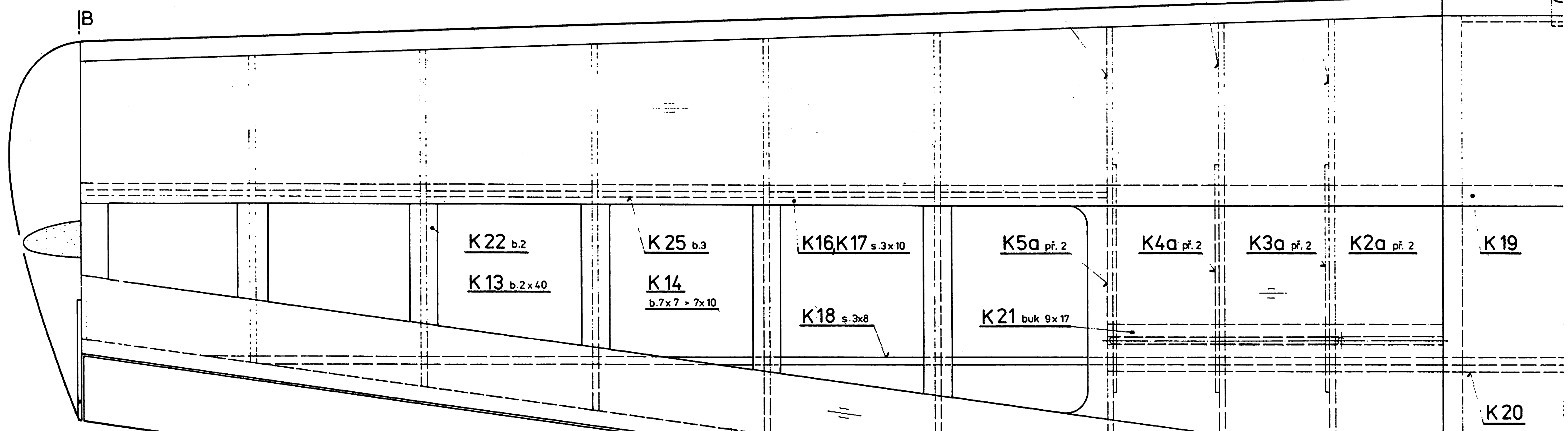
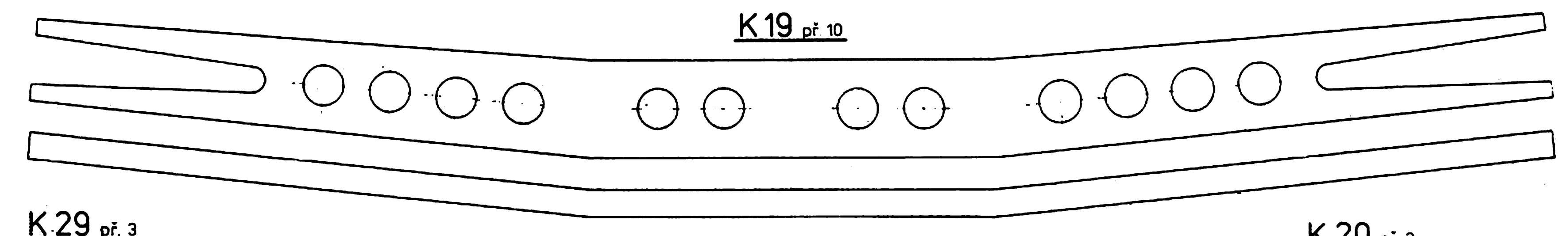

RC POLOMAKETA
PELICAN (IAR-831)
 konstrukce: Jiří PLAČEK
 rozpětí: 1550 mm
 délka: 1245 mm
 hmotnost: 3300 - 3800 g
 motor: 6,5 - 10 cm³
 počet ovl. funkcí: 4