

NOTE: F2A, F2B, F3B, F4, F5, F6, F7 MADE FROM 1/8 SHEET

T-34B MENTOR
BEECHCRAFT

DESIGNED BY	BUD ATKINSON	DRAWN BY	HG SPEER
-------------	--------------	----------	----------

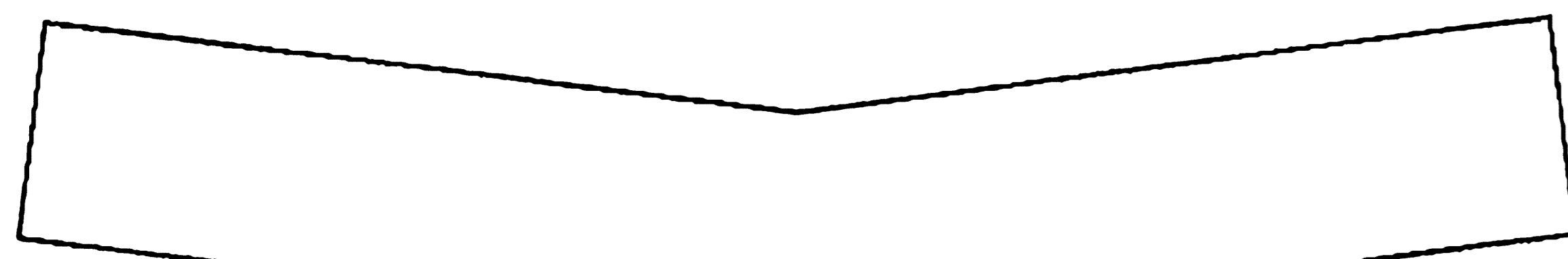

DIHEDRAL BRACE
1/8 PLYWOOD-2 REQUIRED

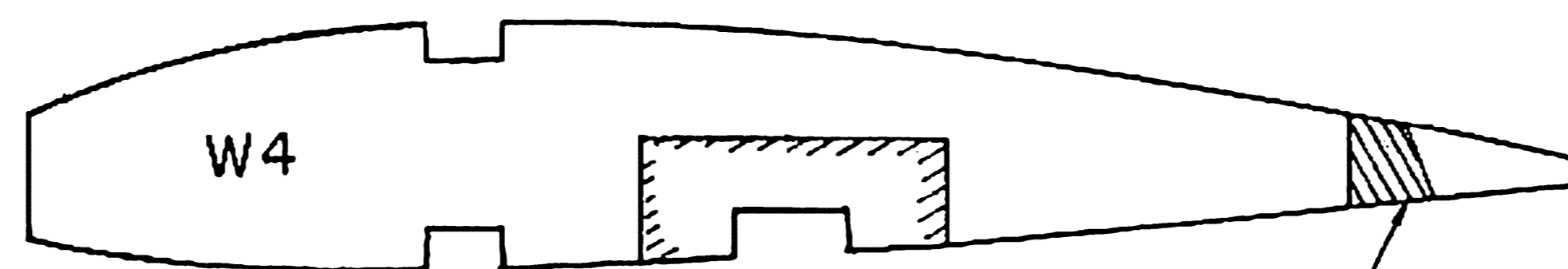
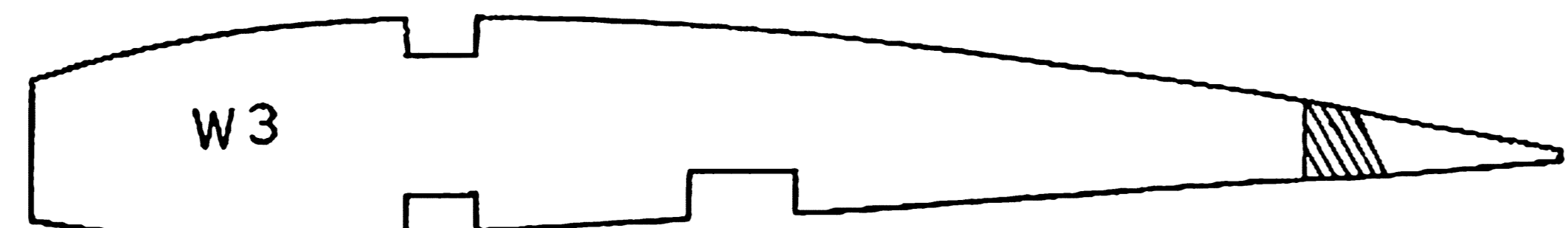
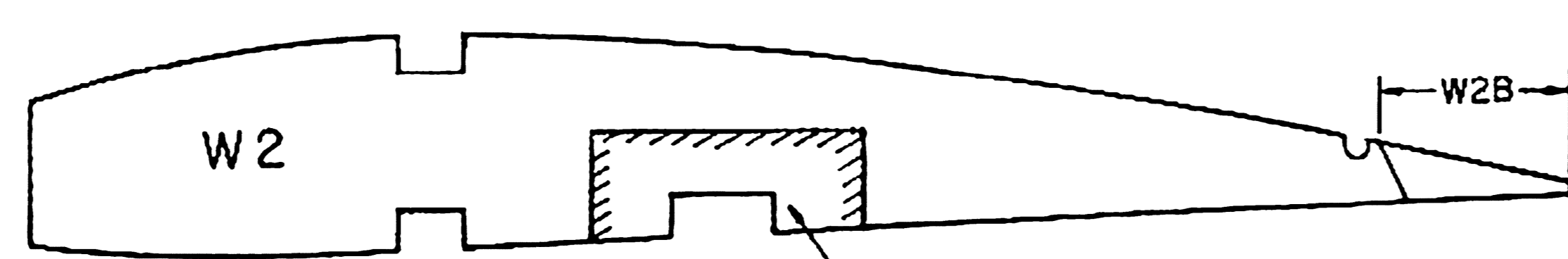
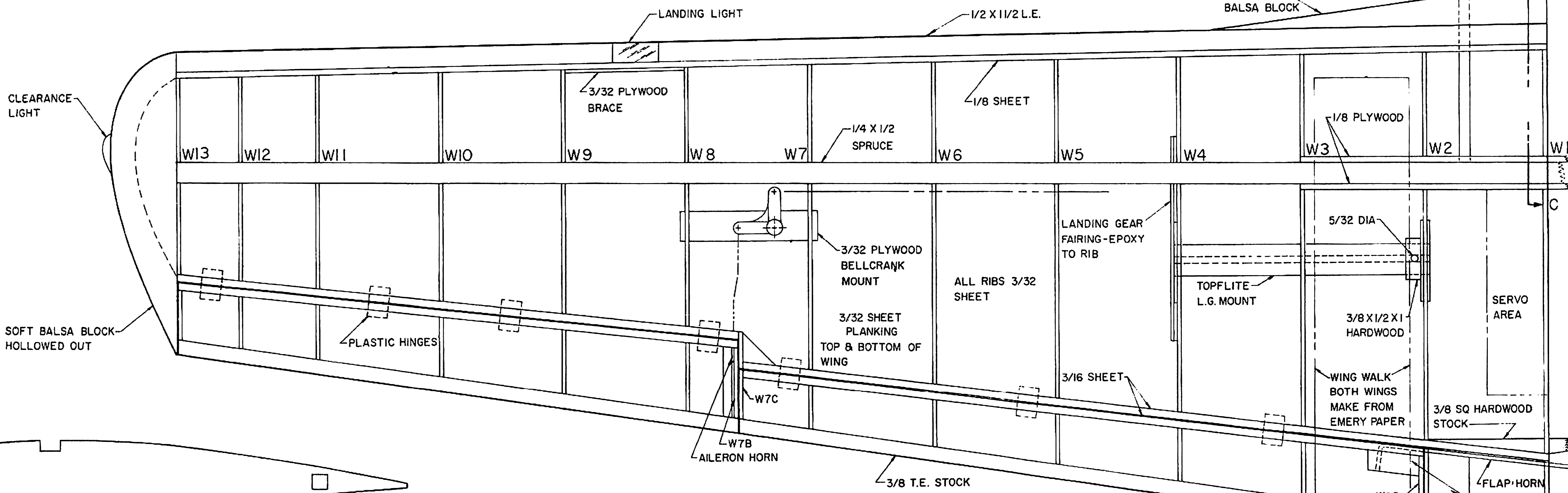
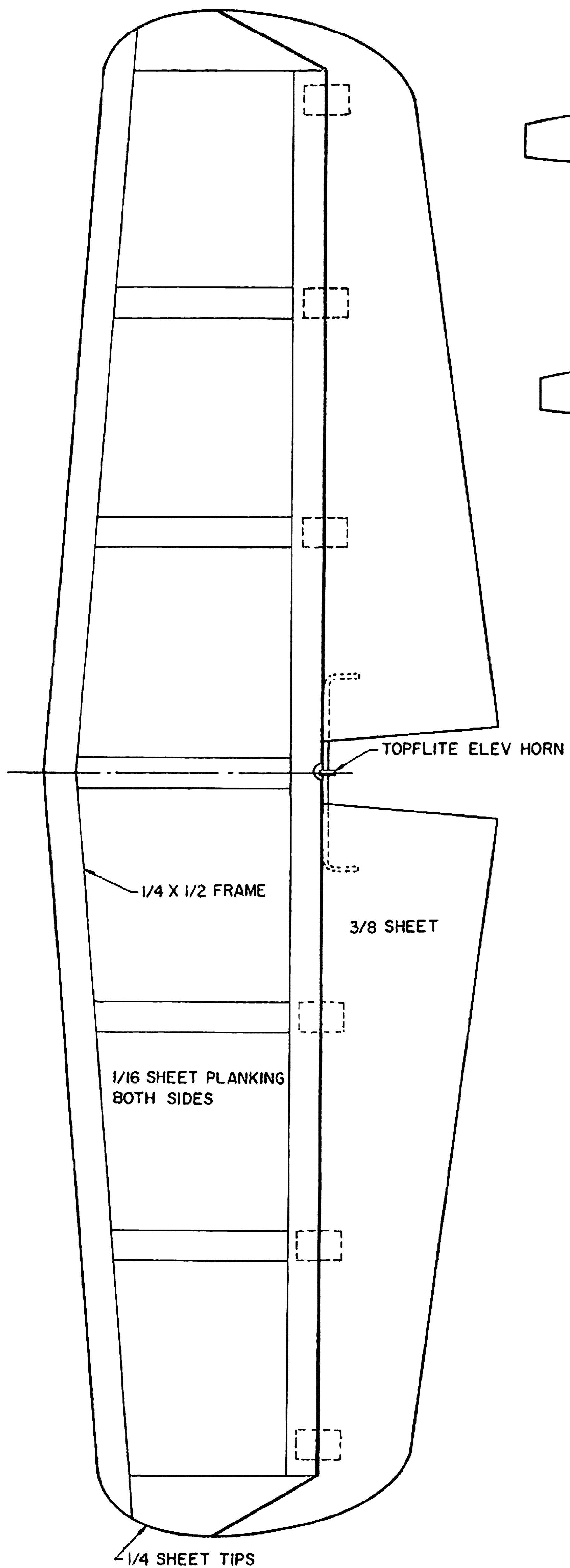
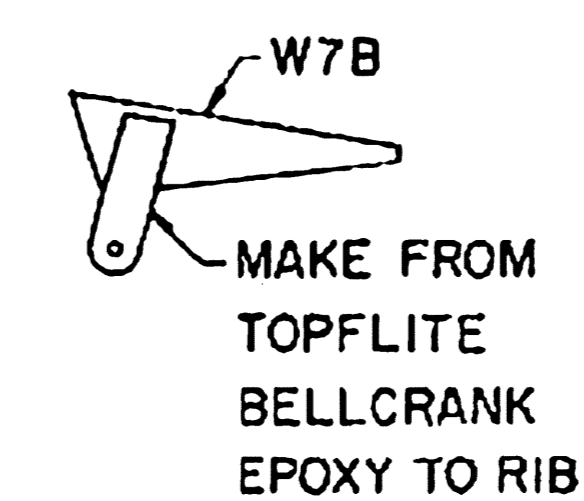
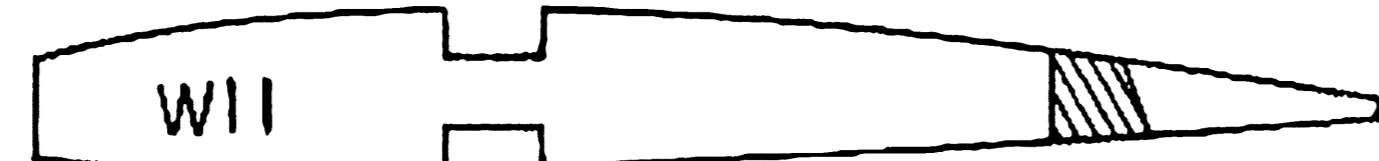
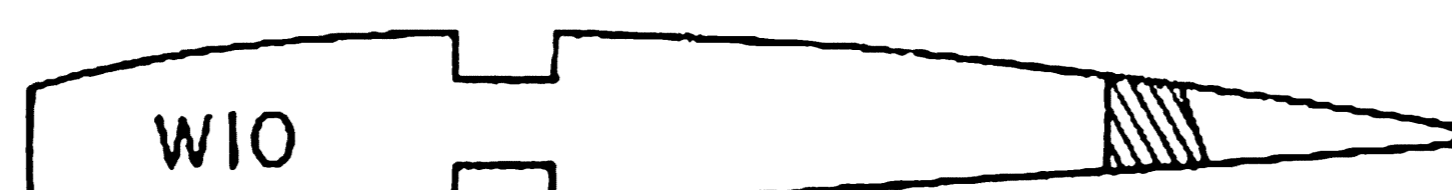
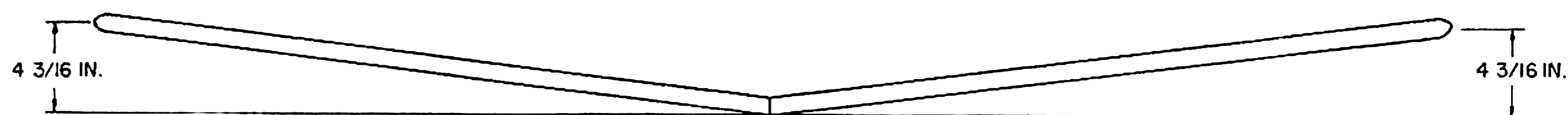

SEC C-C

