

CELLULOID WINDSHIELD

SOME STRINGERS NOT SHOWN ON FUSELAGE PLAN TO REVEAL 1/16" SHEET KEEL PIECES

RUDDER IS BUILT INTEGRAL WITH FUSELAGE

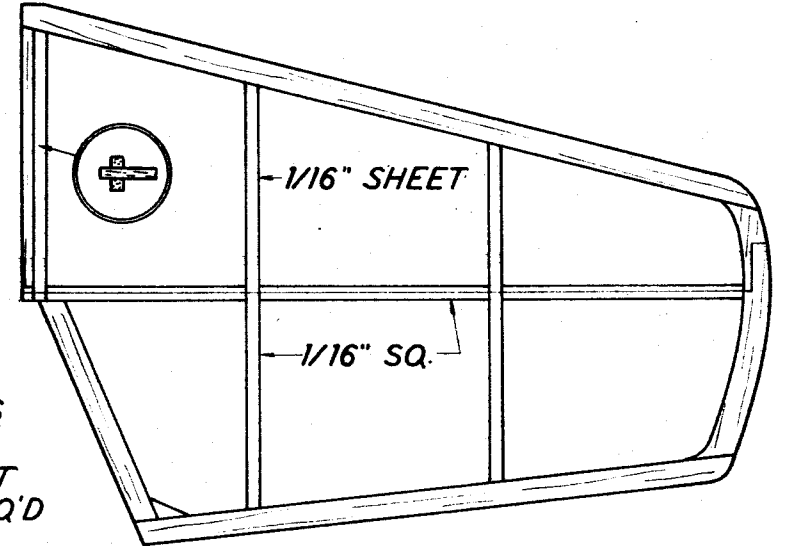
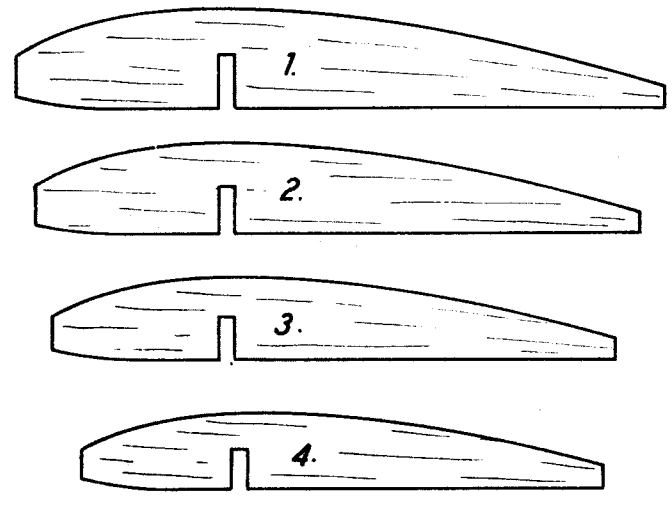
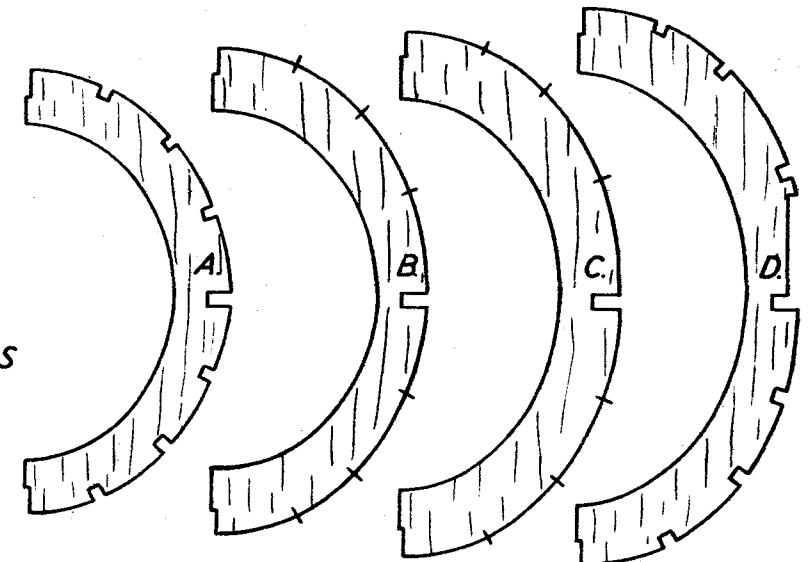
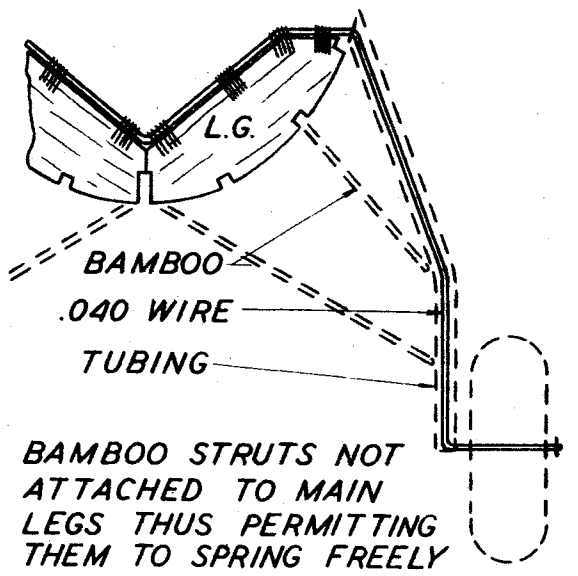
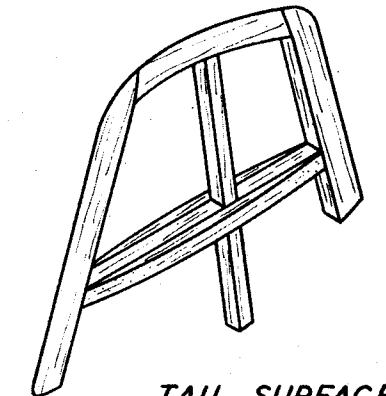
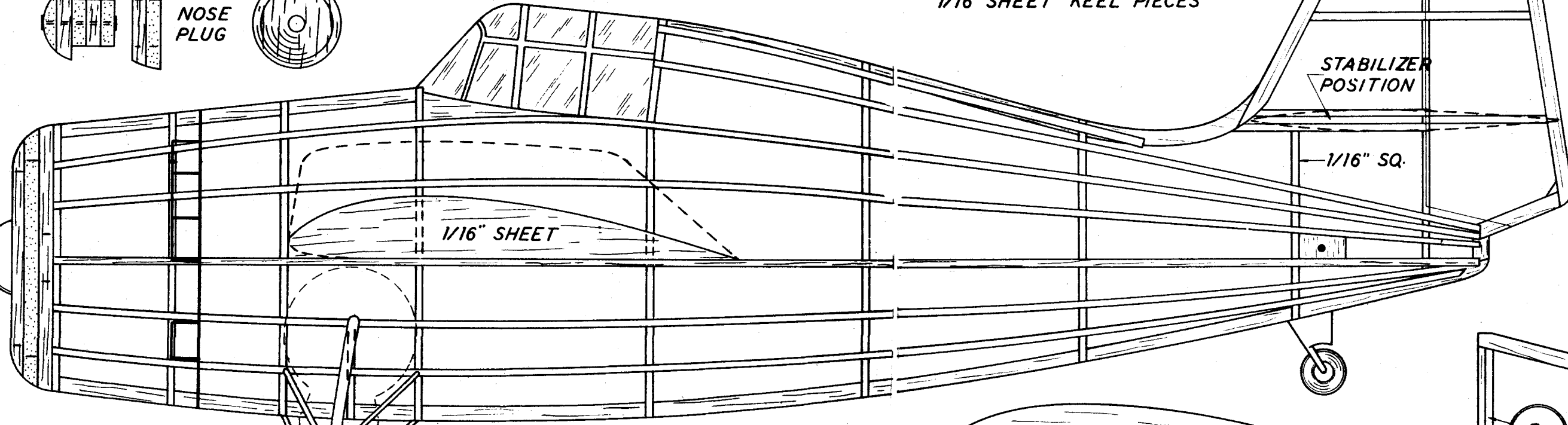

BAMBOO STRUTS NOT ATTACHED TO MAIN LEGS THUS PERMITTING THEM TO SPRING FREELY

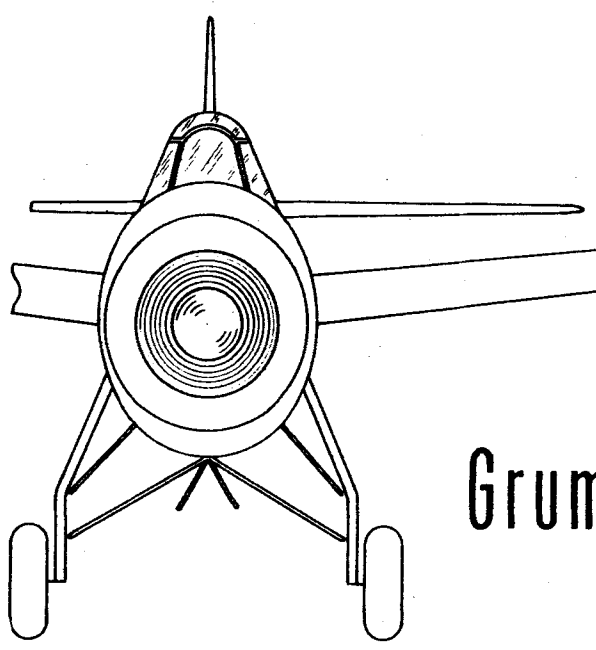

Grumman Wildcat

