

THIS PANEL SHOWN WITHOUT L.E. & CENTER SECTION SHEETING

1/16" SHEET Balsa (TOP CENTER SECTION)

1/4" X 3/8" Balsa LEADING EDGE

1/16" X 2" Balsa LEADING EDGE SHEETING (TOP ONLY)

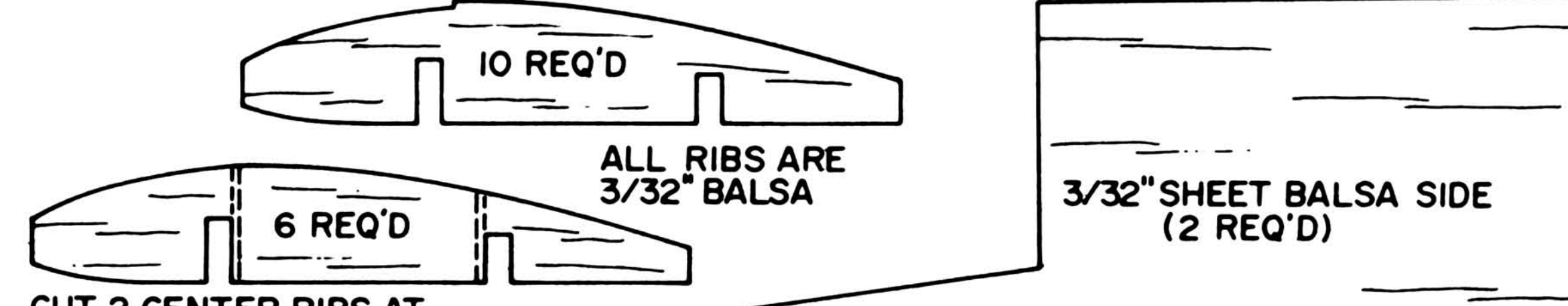
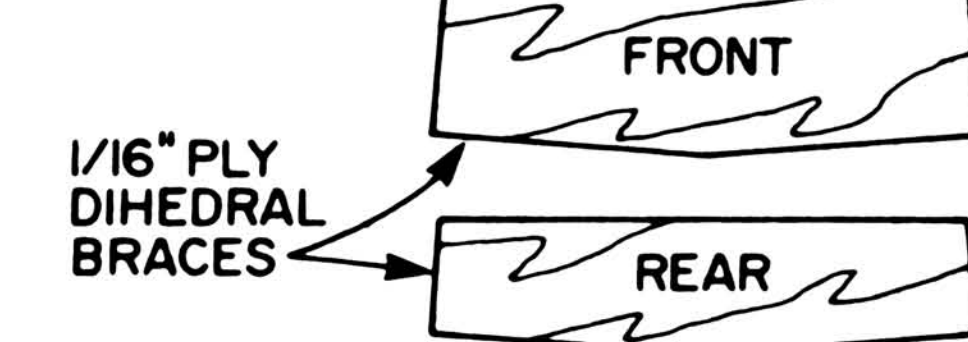
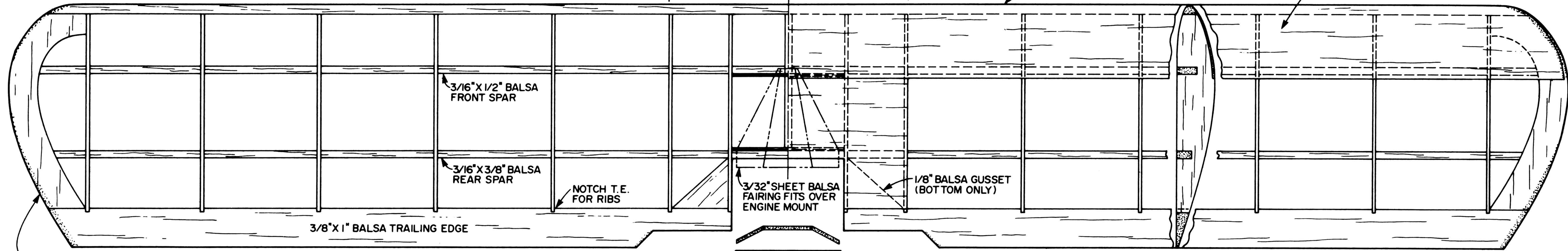

1-1/2" DIHEDRAL UNDER EACH TIP

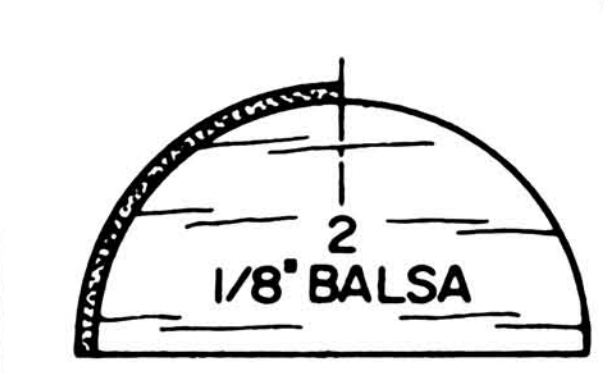
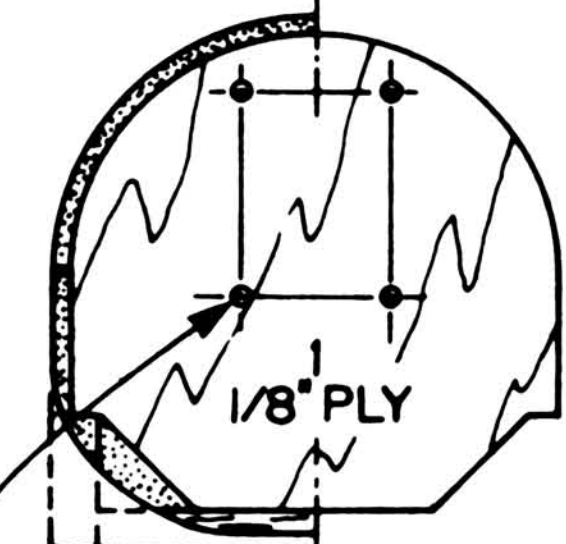
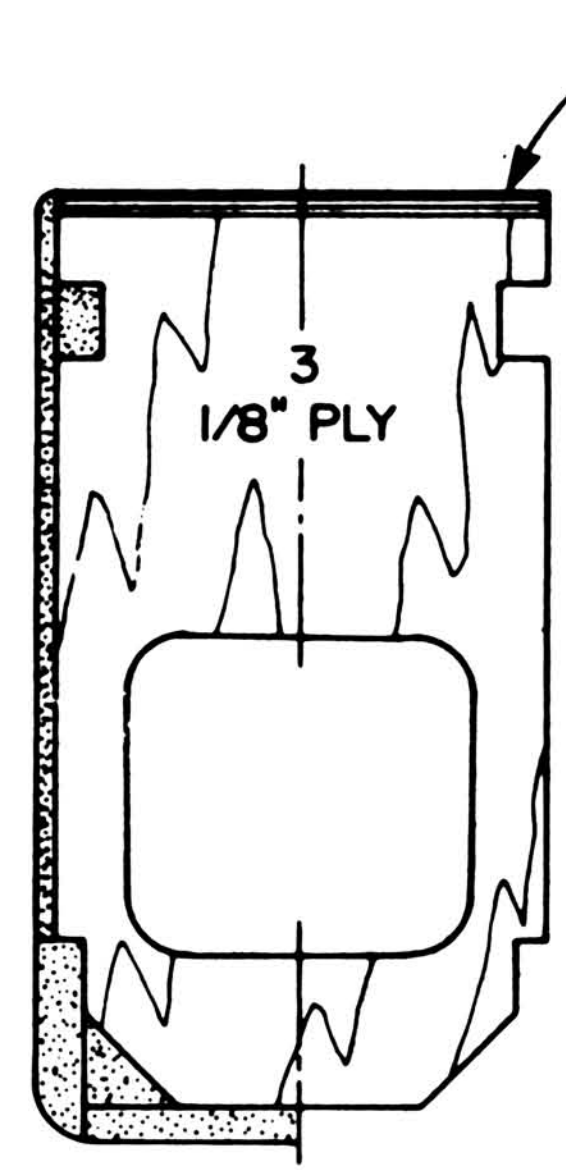
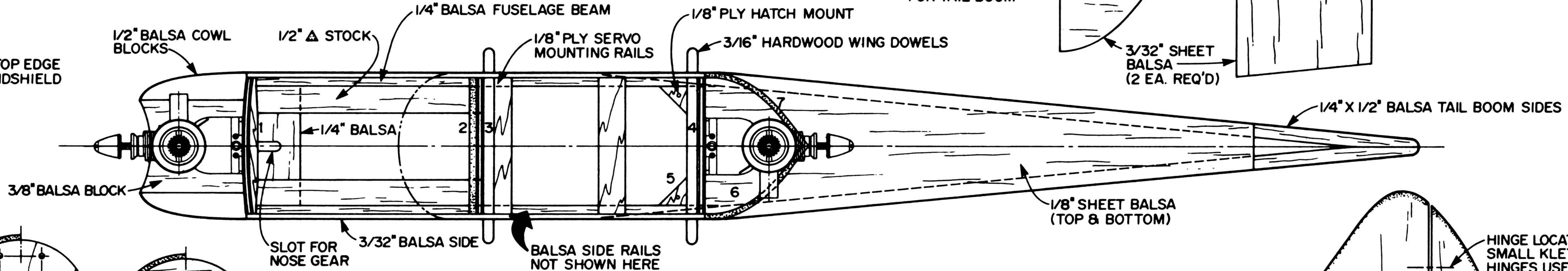
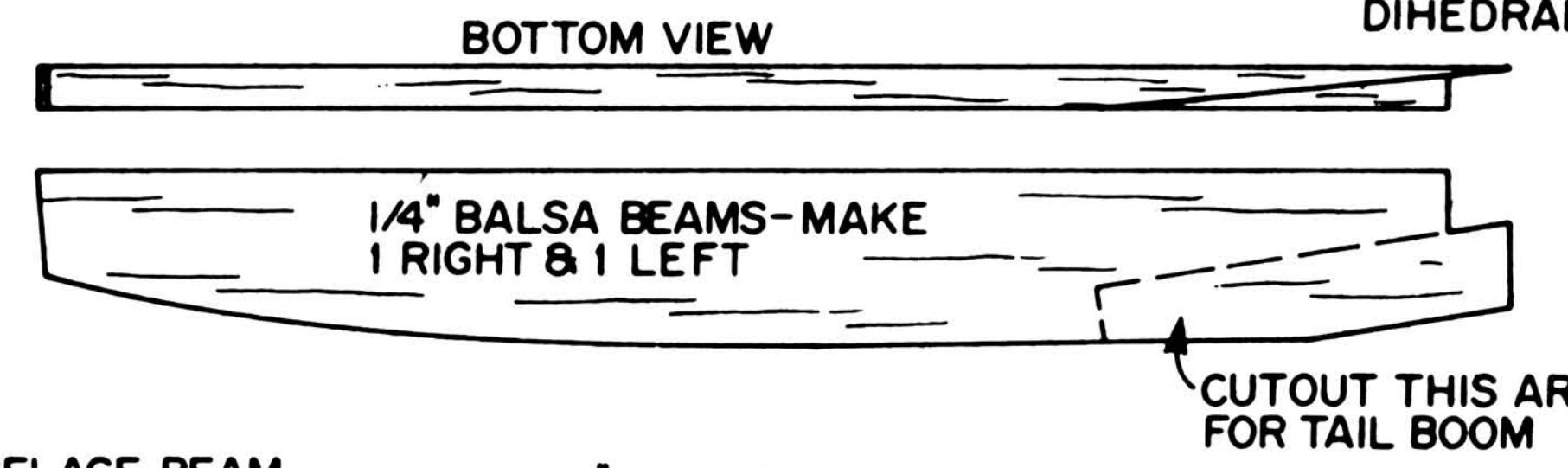
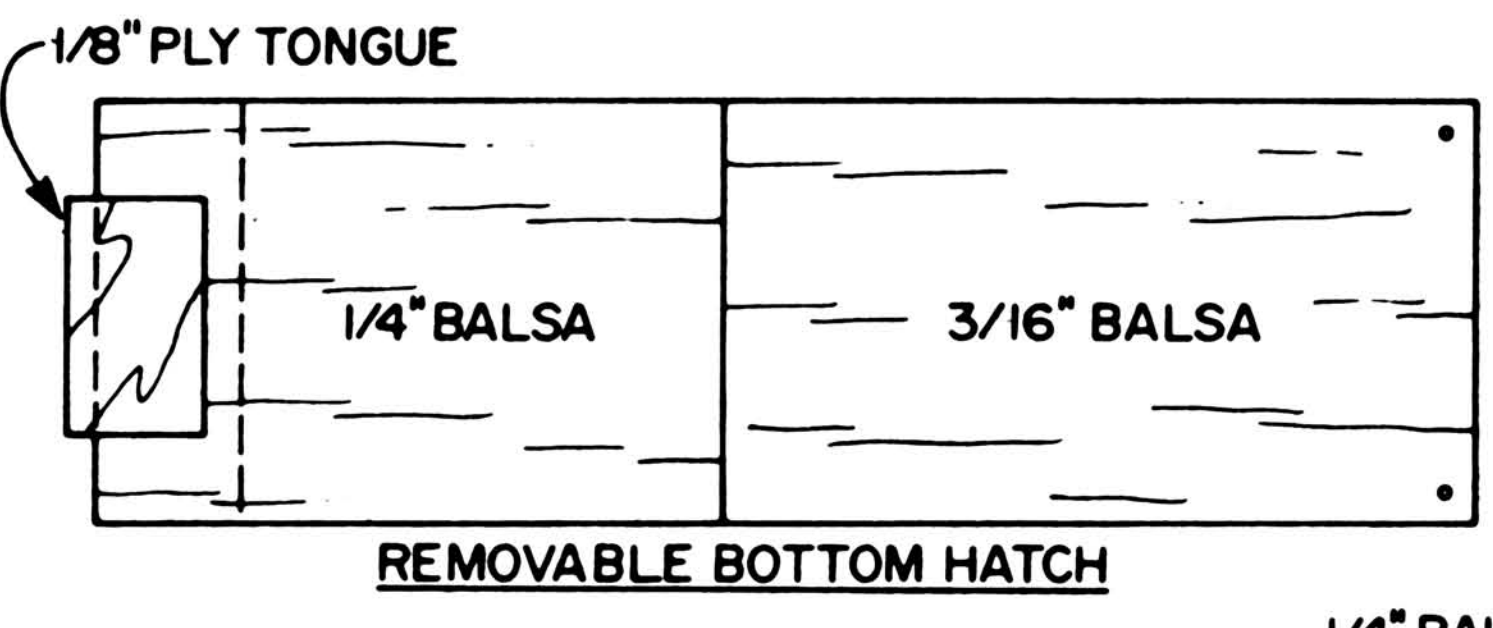
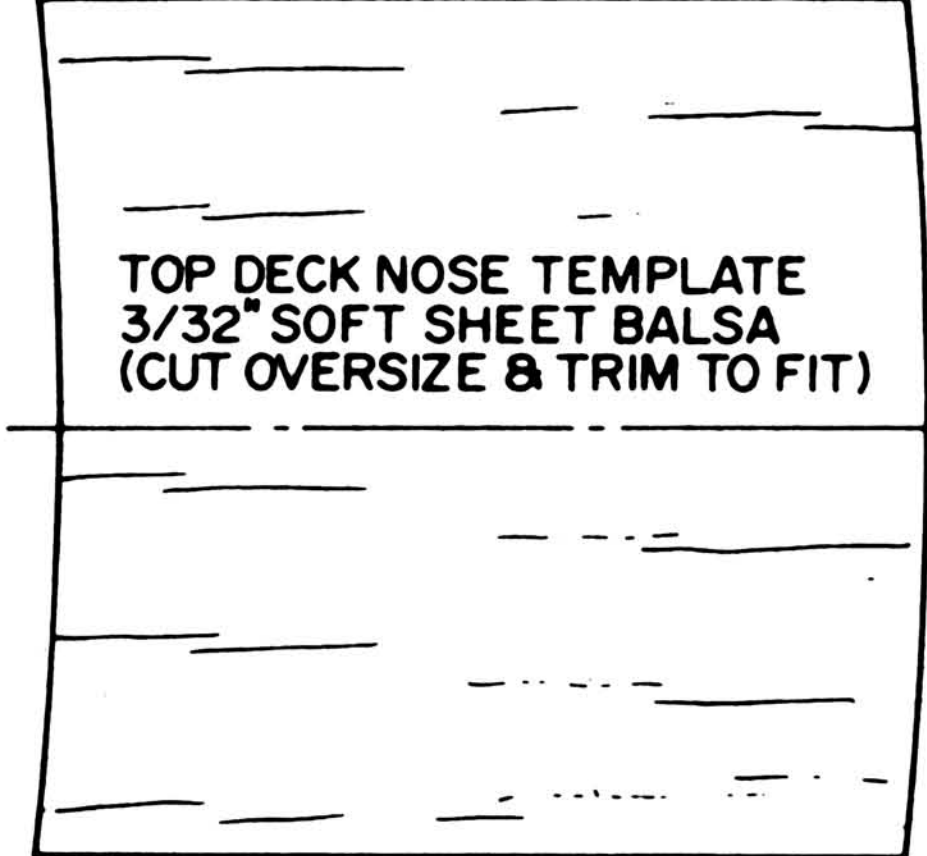

MOUNTING HOLES SHOWN FOR QRC. USE 2-56 BLIND MTG. NUTS

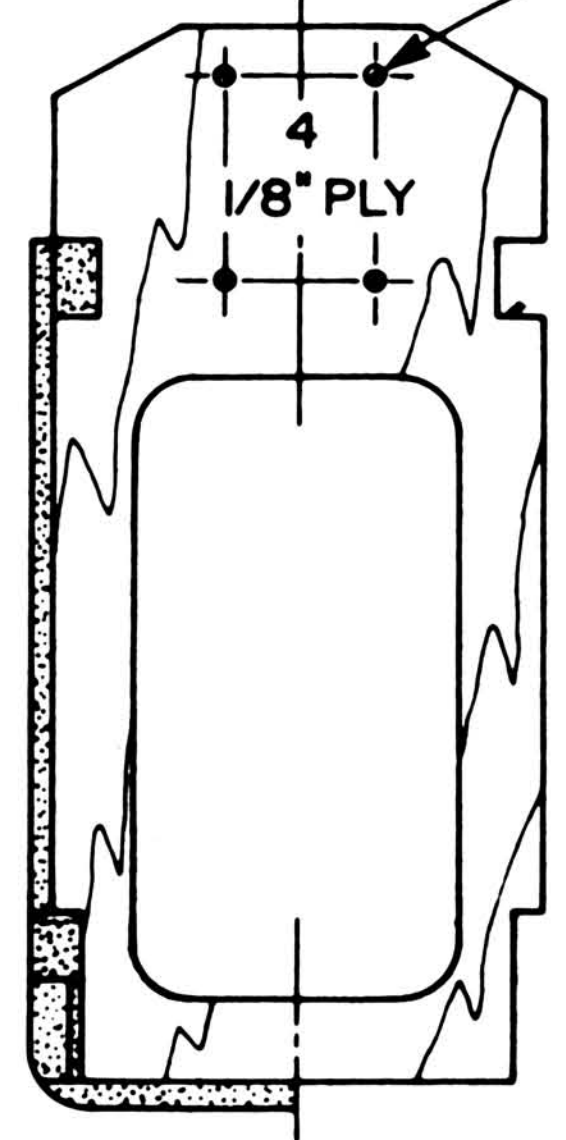

FRONT ENGINE HAS 3° DOWN THRUST BUILT INTO FIREWALL

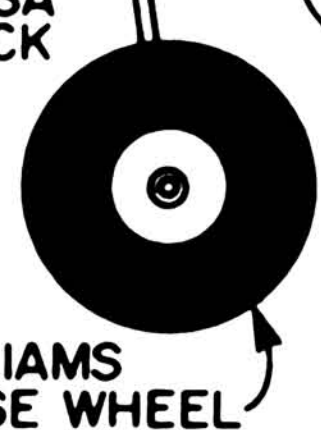

HATCH MADE FROM 1/4 & 3/16 Balsa

1/8 Ply Servo Mounts - SPACE TO SUIT SERVOS

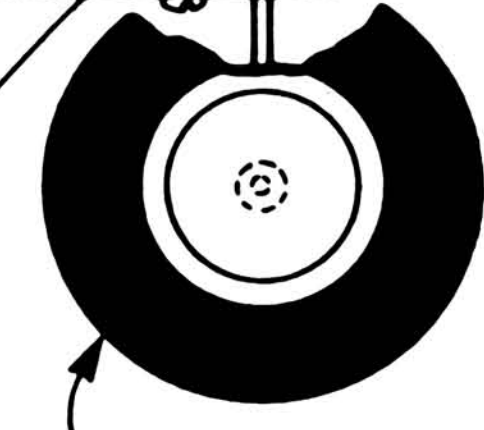

COX QRC .049 SHOWN. USE COX 6-3 PUSHER & 6-3 TRACTOR PROPS.

REAR ENGINE MOUNTED WITH 0°-0° THRUST

NOTE: AT C.G. LOCATION MODEL SHOULD BALANCE SLIGHTLY IN NOSE DOWN ATTITUDE

1/8 SHEET Balsa Tail Boom (TOP & BOTTOM)

CUT FROM 3/16 HARD Balsa & RECESS SHADED AREA FOR L.G. WIRE

LANDING GEAR RETAINER

3/32 Music Wire MAIN LANDING GEAR

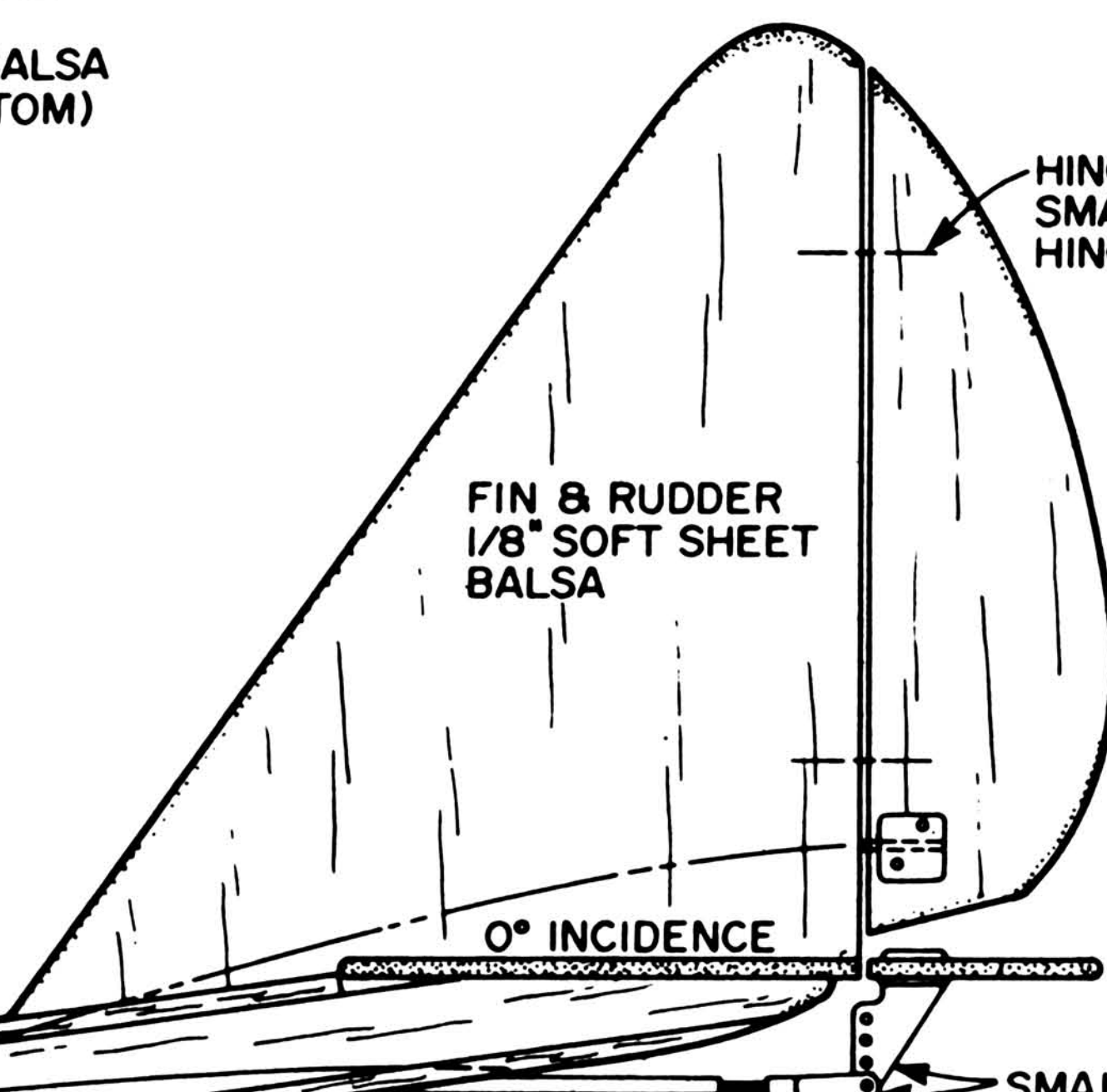

HINGE LOCATION SMALL KLETT HINGES USED

SMALL GOLDBERG CLEVIS & HORNS

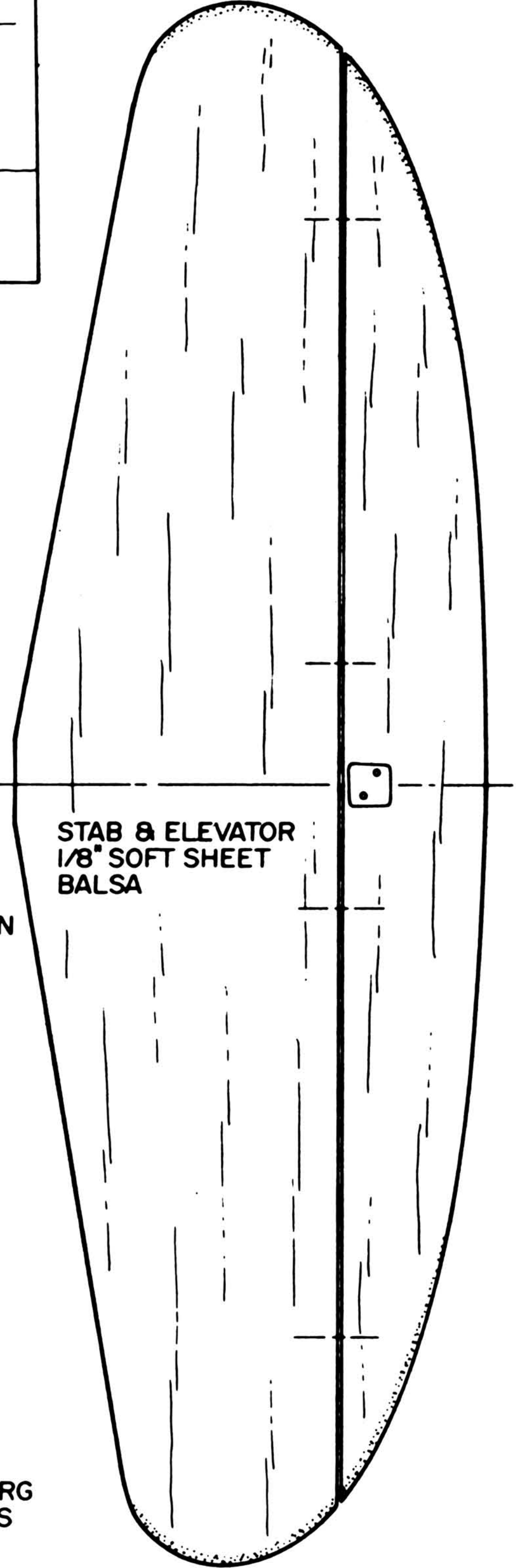

© RCM ALL COMMERCIAL RIGHTS RESERVED

RCM TWIN SCOOTER

DESIGNED BY DICK TICHENOR INKED BY DICK KIDD

