

NOTE RADIO RECEIVER IS LOCATED ADJACENT TO THROTTLE SERVO

NOTE ALL RADIO COMPONENTS SHOWN ARE AIRTRONICS

NOTE WRAP LANDING GEAR LEGS WITH FIBER GLASS

NOTE ALL WOOD IS BALSAs, UNLESS NOTED OTHERWISE



© ALL COMMERCIAL RIGHTS RESERVED

**PHONIX**

A WORLD WAR I SCALE DESIGN

DESIGNED & DRAWN BY LADDIE MIKULASKO

PLANS BY Bob Walker

SHEET 1 OF 3

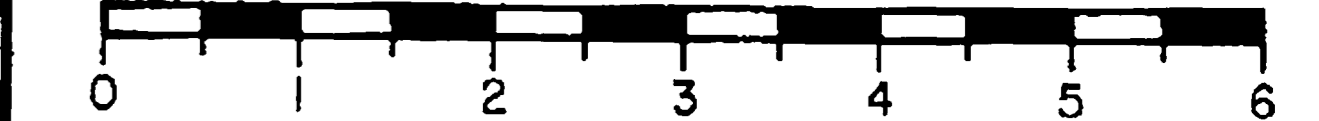

PLAN NO. 1106 (3)

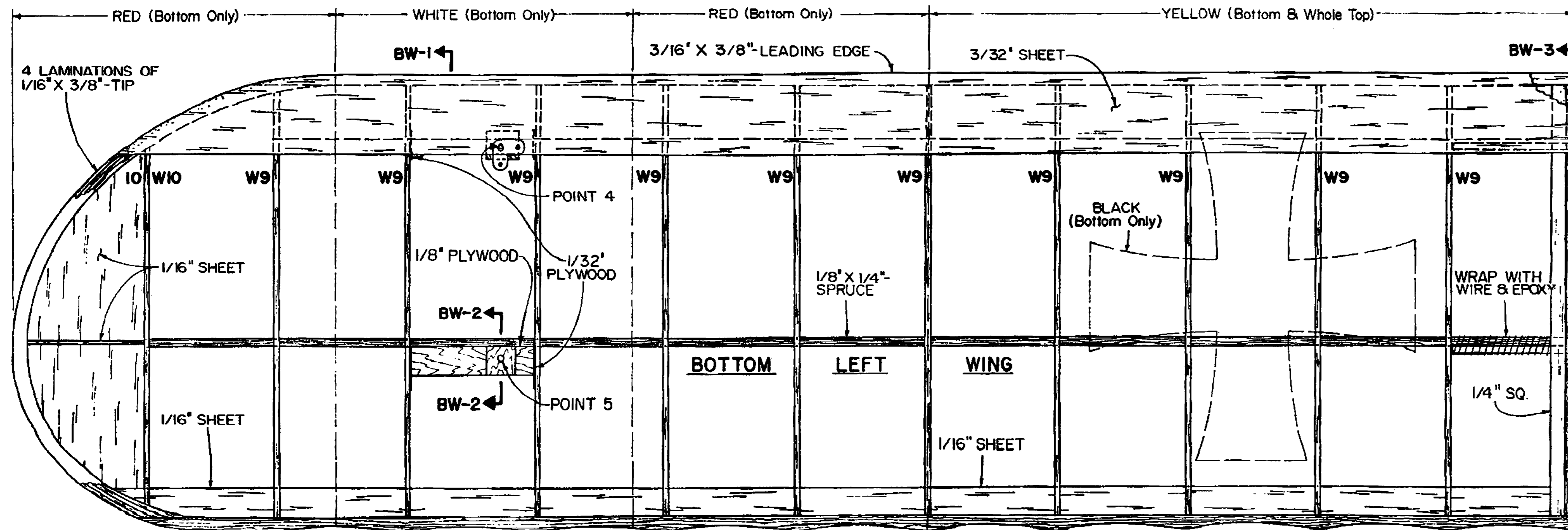

**WING RIGGING CONNECTING GUIDE**

- POINT 1 TO 9
- POINT 2 TO 8
- POINT 3 TO 8
- POINT 4 TO 6
- POINT 4 TO 9
- POINT 5 TO 8
- POINT 5 TO 7

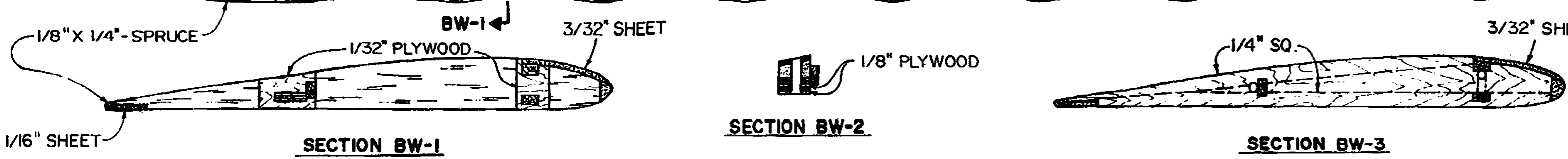
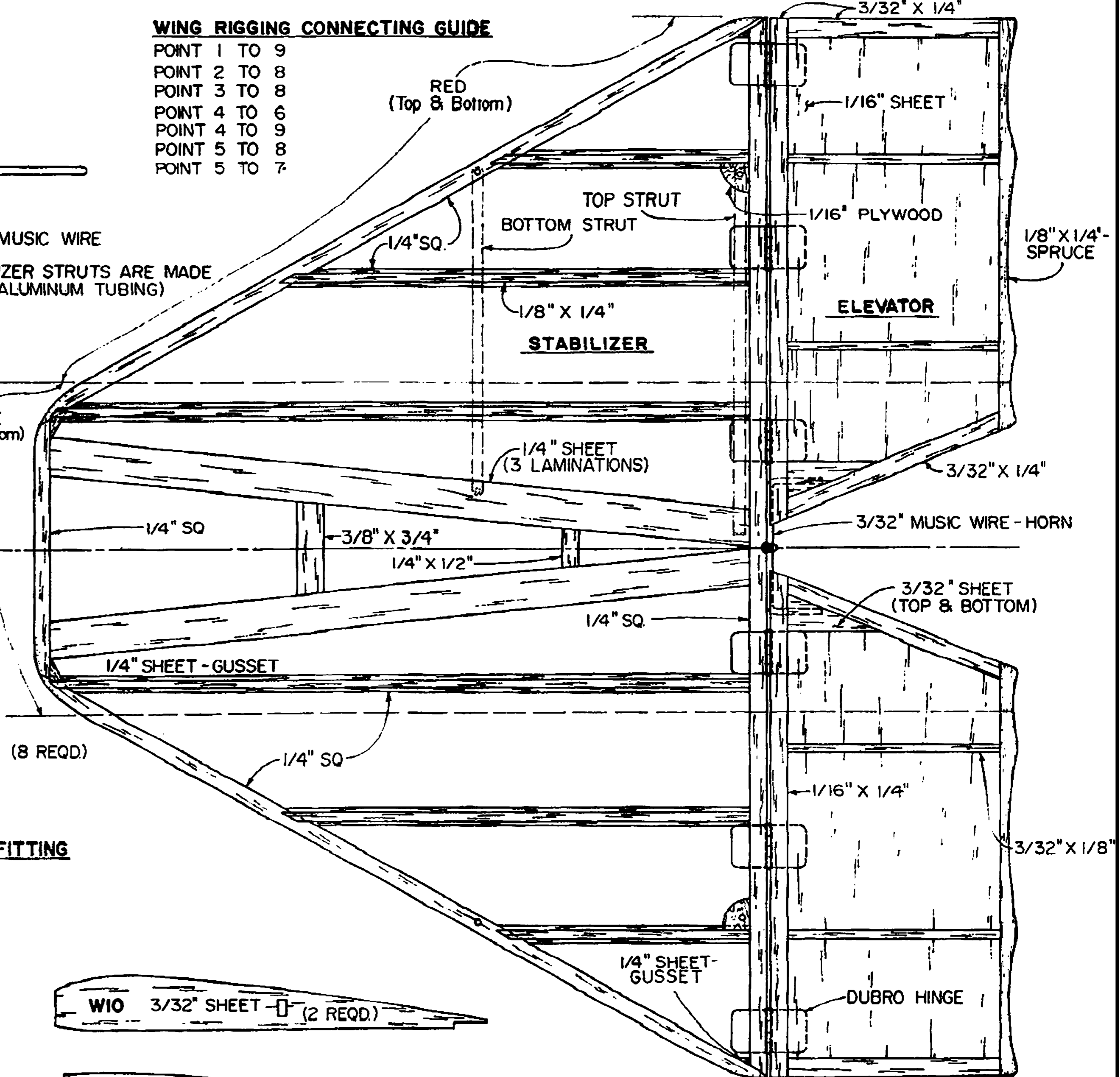

**WING STRUT RIGGING FITTING**

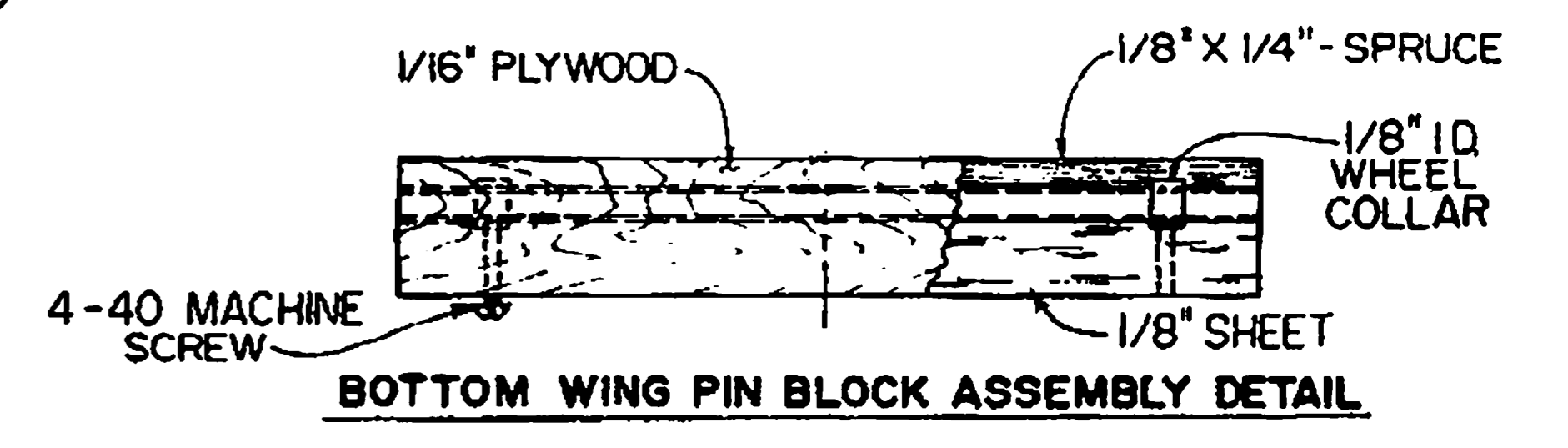
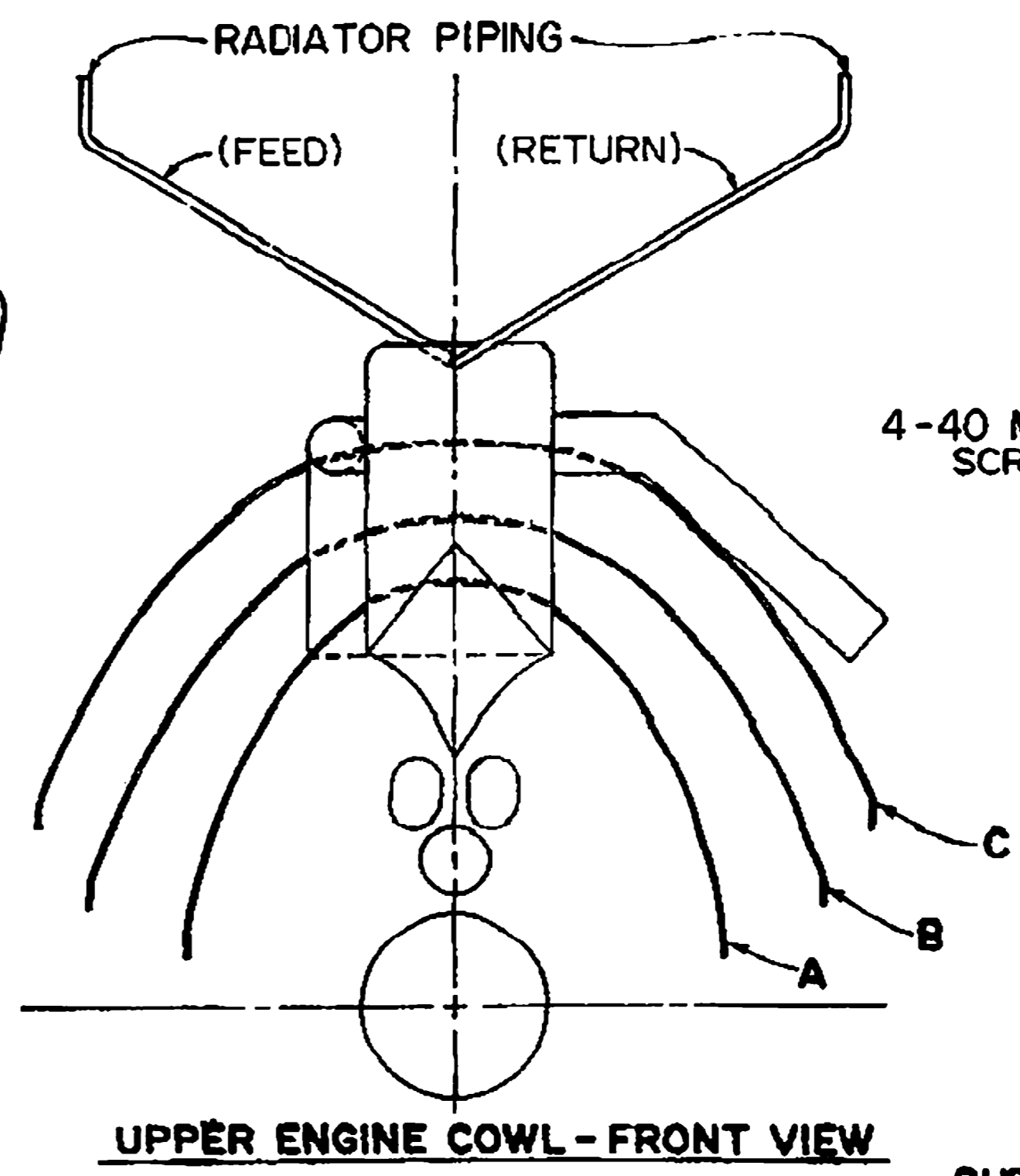
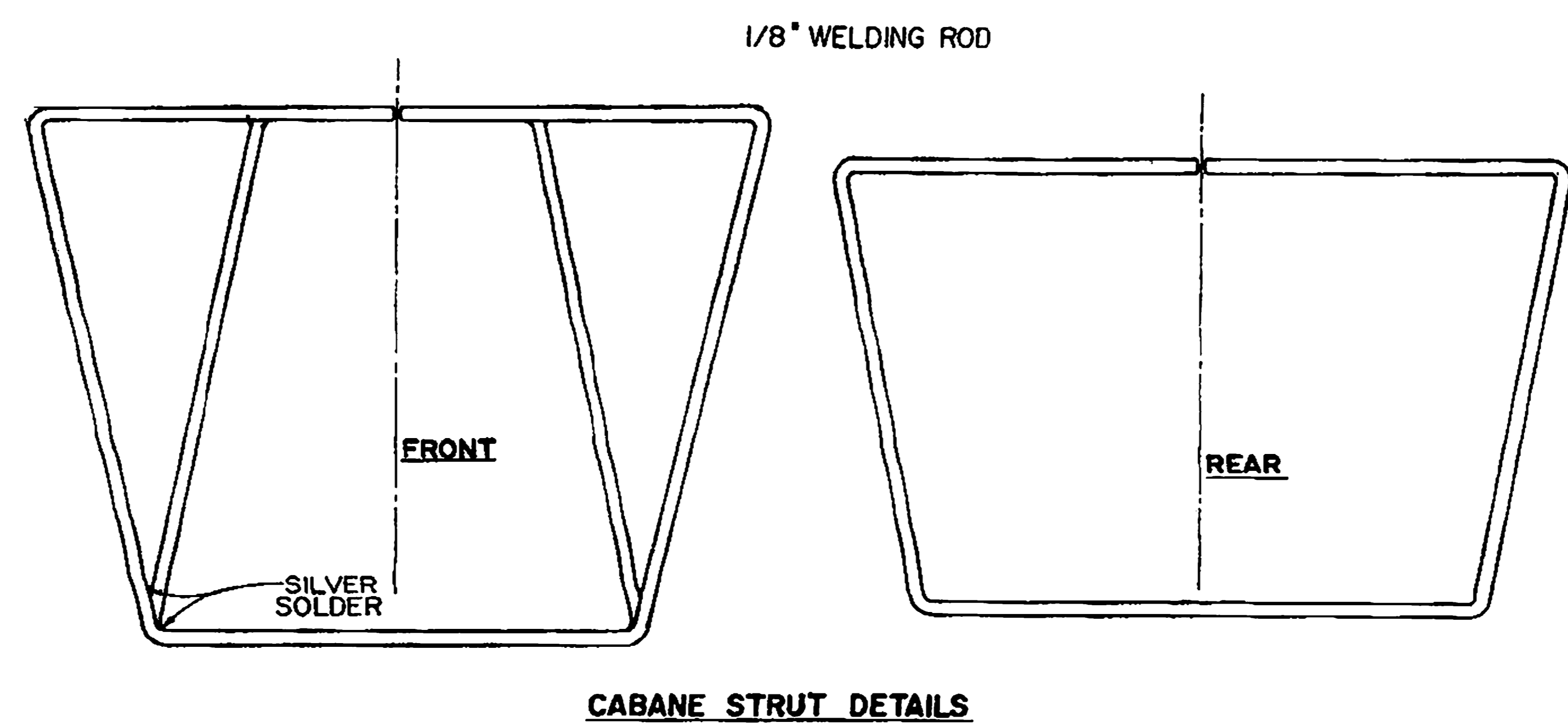
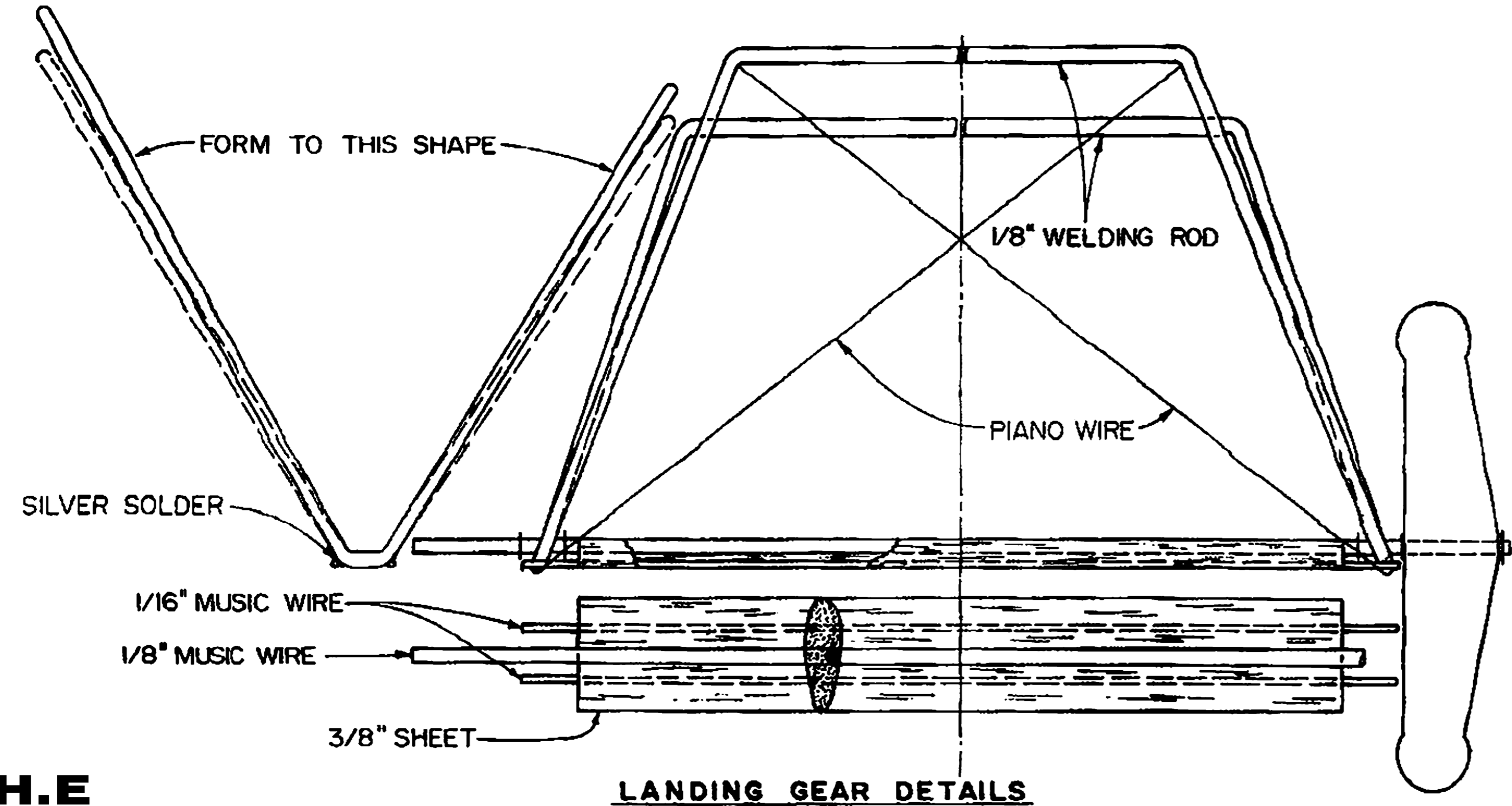
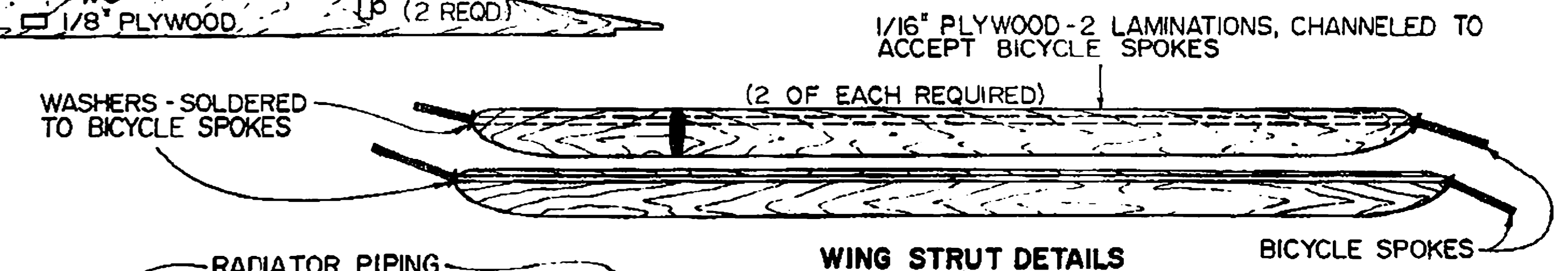
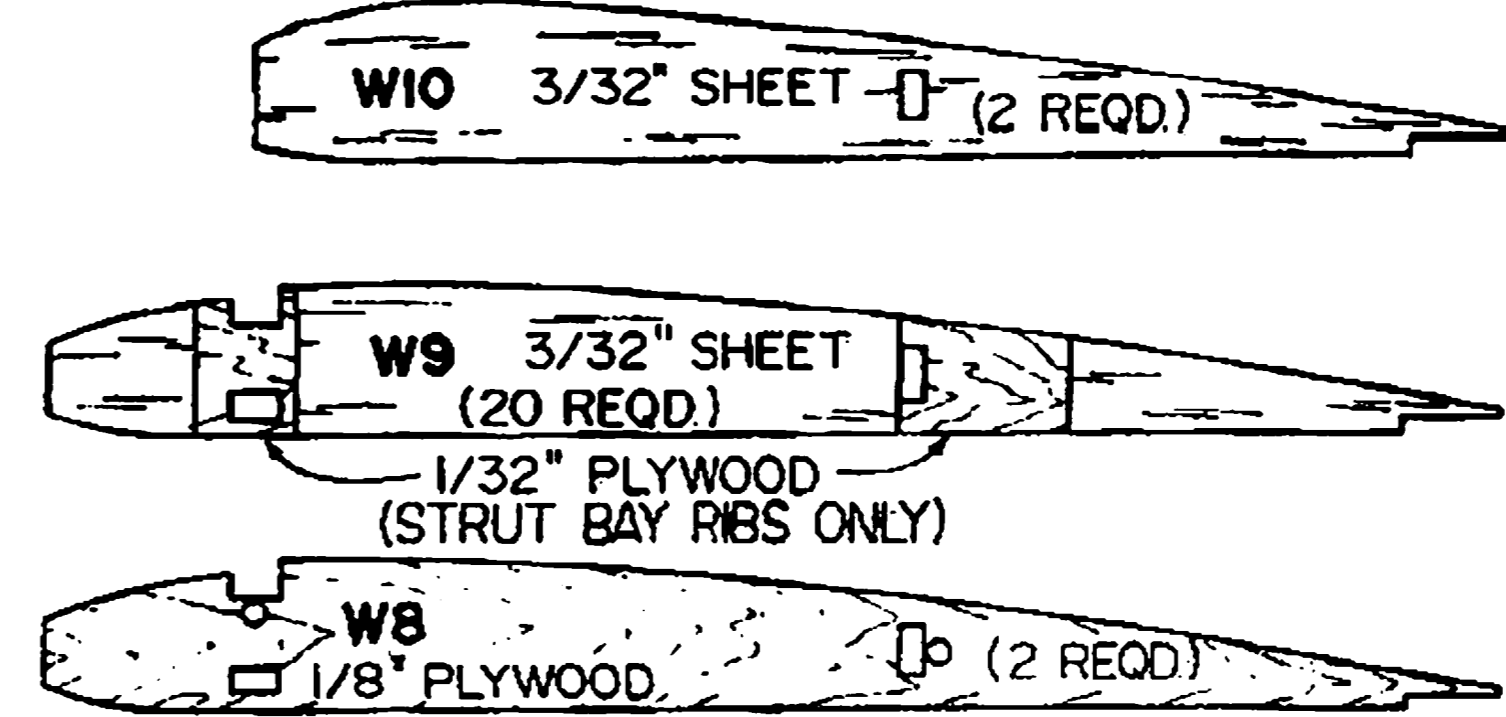
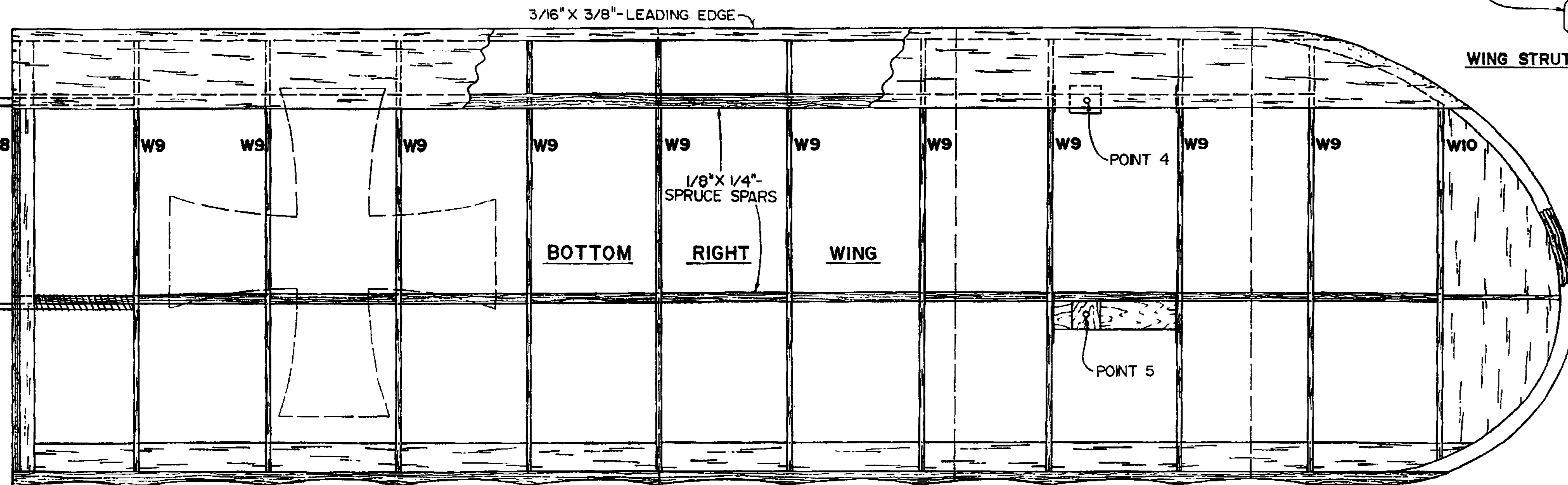
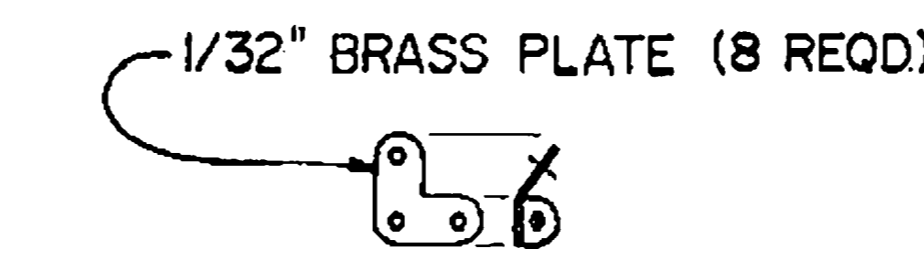

© ALL COMMERCIAL RIGHTS RESERVED

**PHONIX**

A WORLD WAR I SCALE DESIGN

DESIGNED & DRAWN BY LADDIE MIKULASKO

PLANS BY *Bob Wilbur*

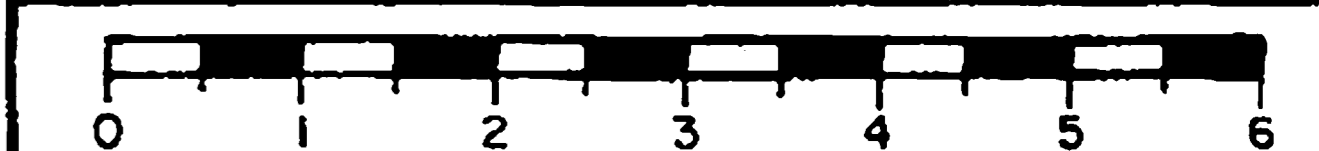

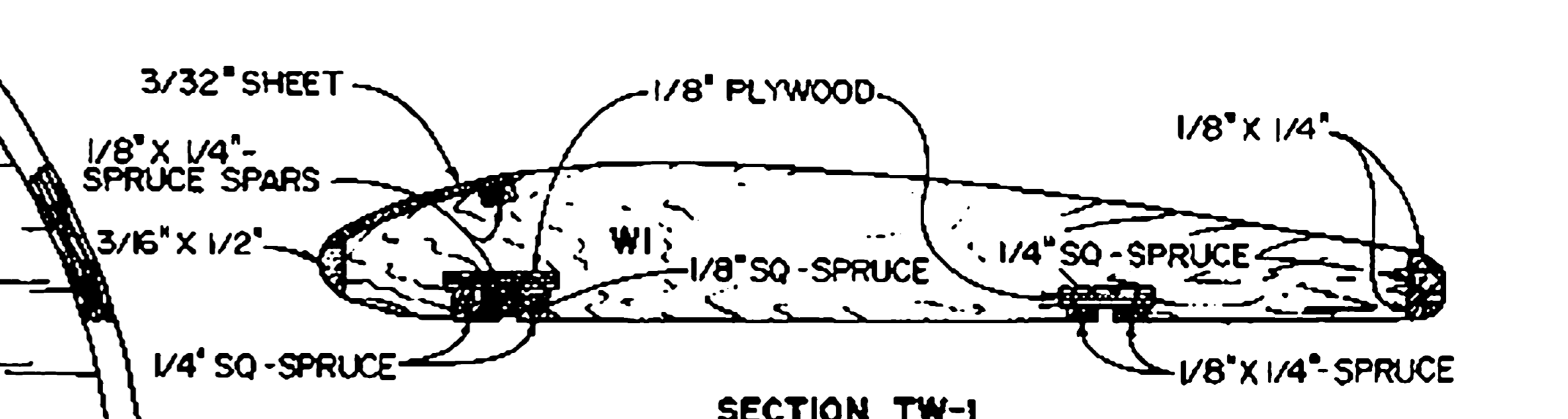
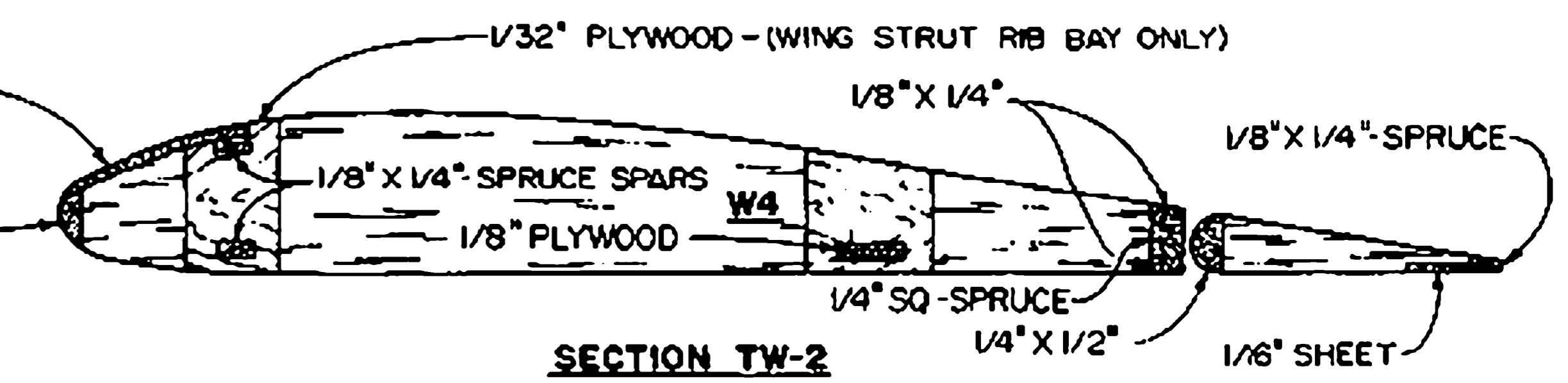
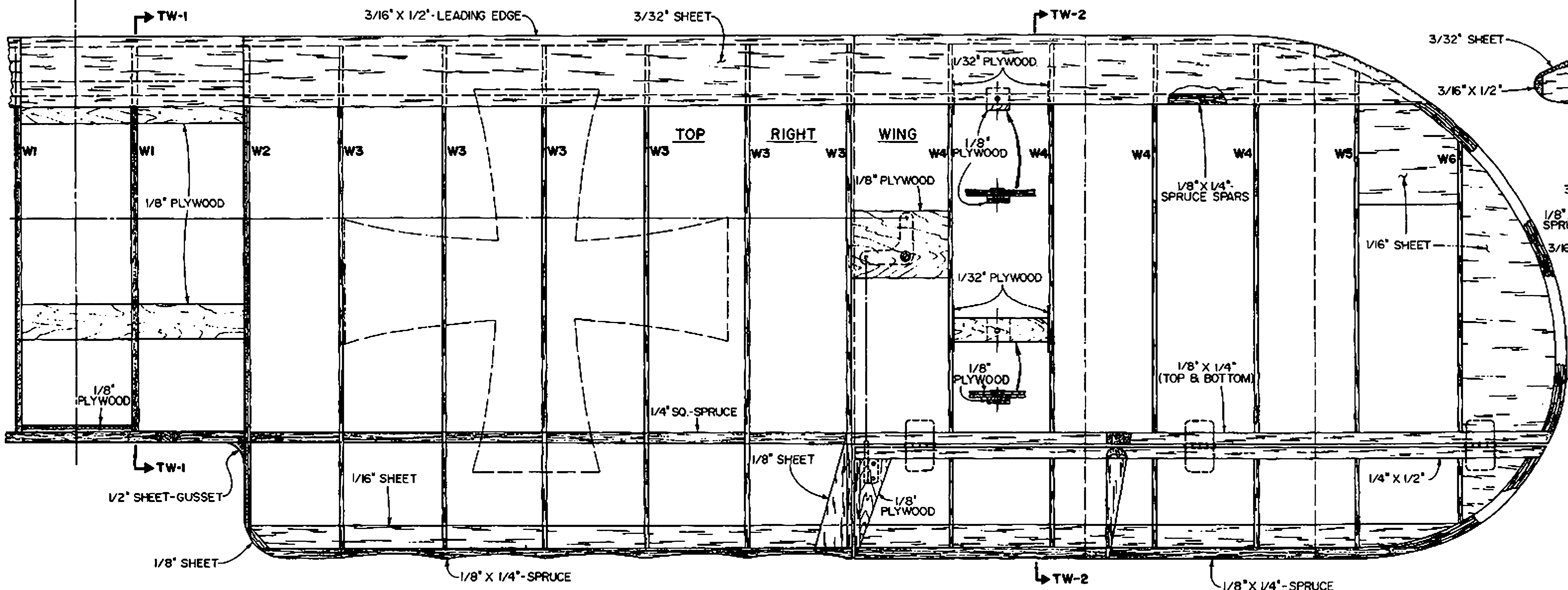
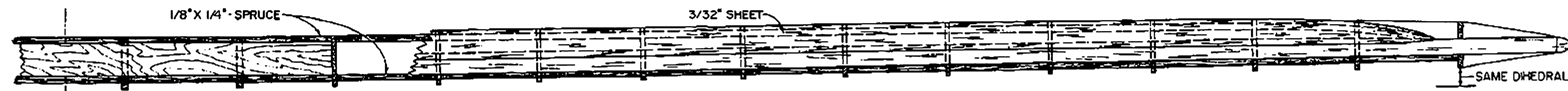
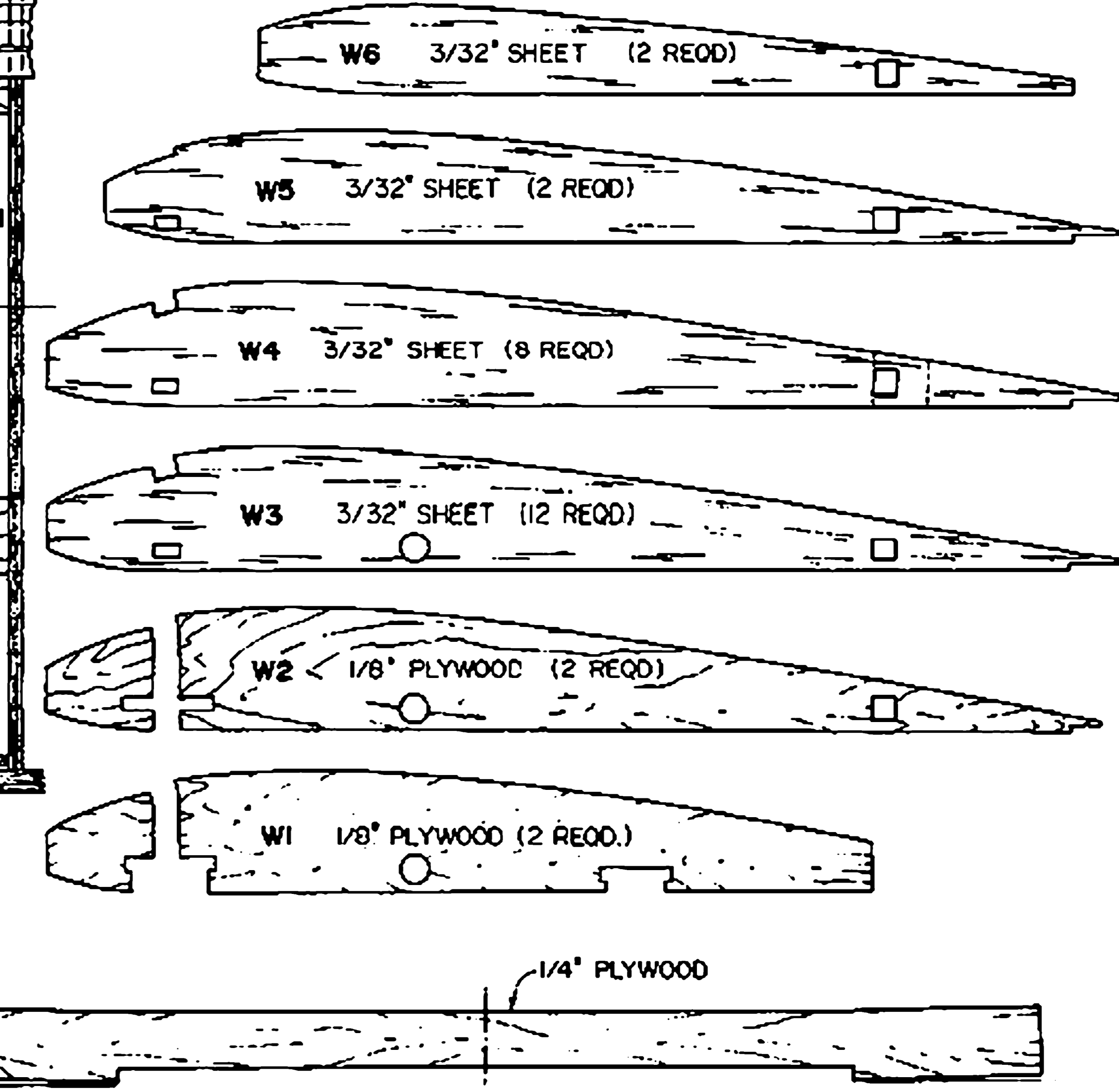
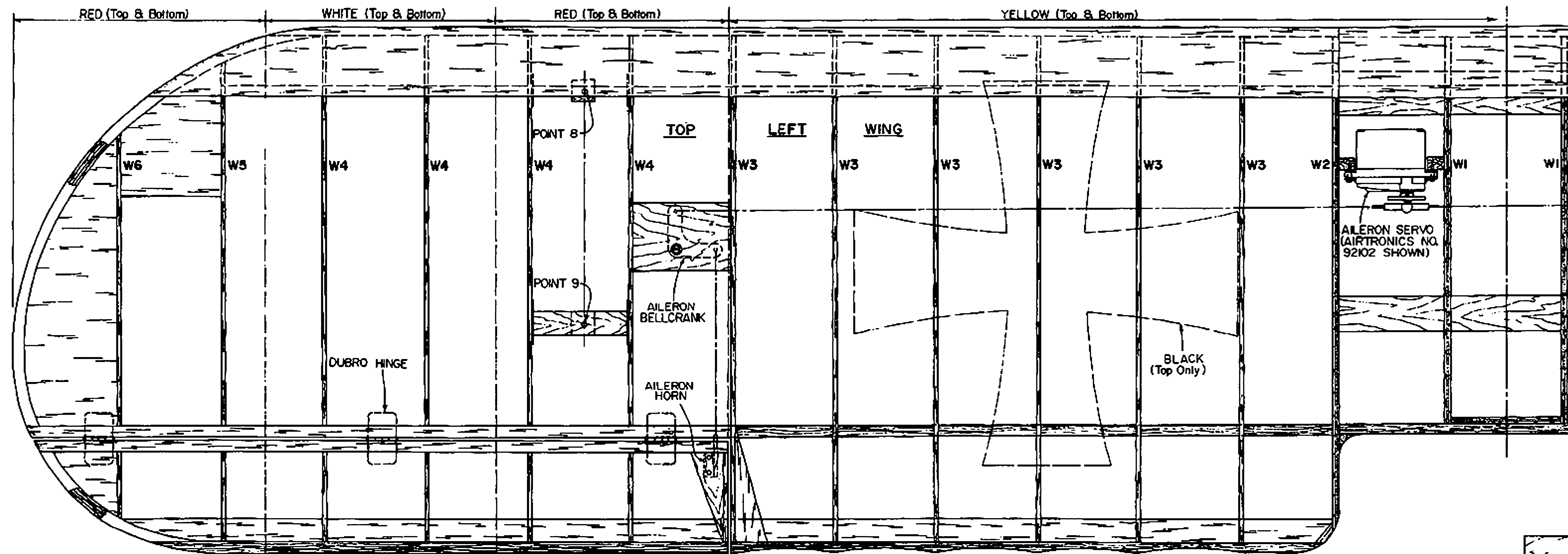

H.E

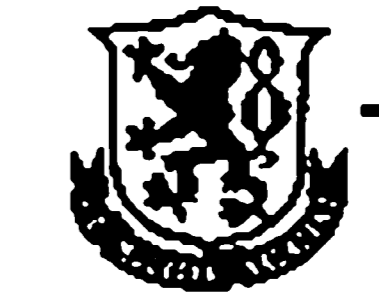

© ALL COMMERCIAL RIGHTS RESERVED

**PHONIX**  
A WORLD WAR I SCALE DESIGN

DESIGNED & DRAWN BY LADDIE MKULASKO  
PLANS BY *as 2/11/14*

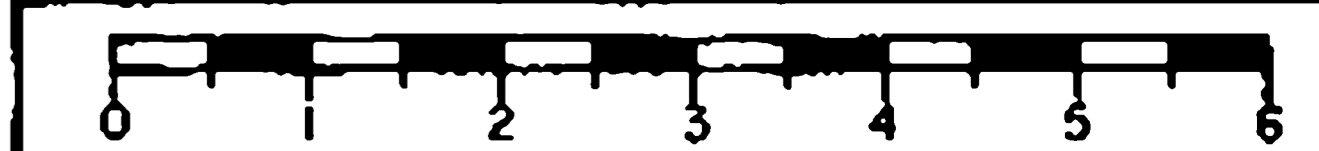

SHEET 3 OF 3

PLAN NO. 1106 (3)