

Scale

Scale Prop

Flying Prop

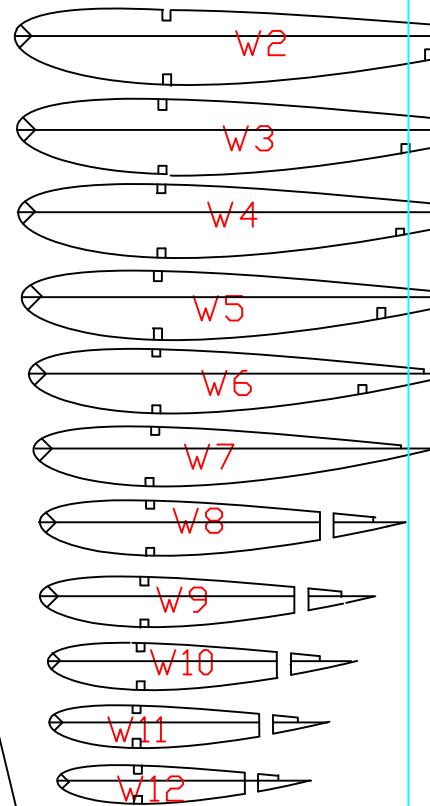

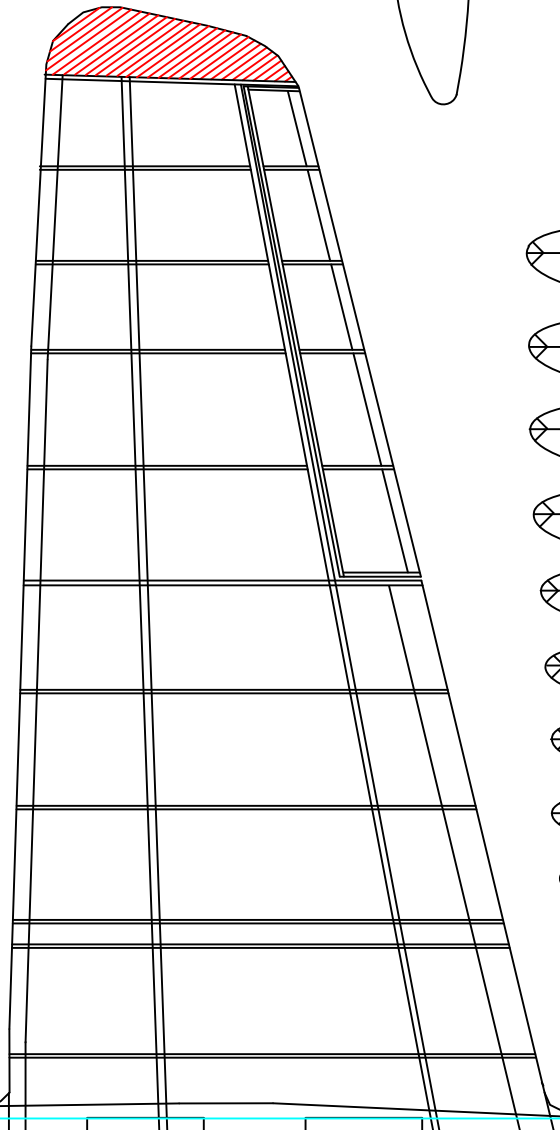
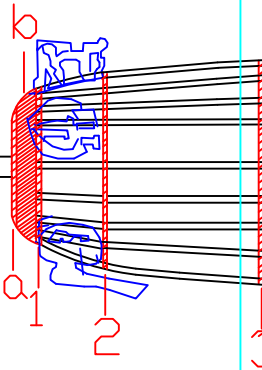
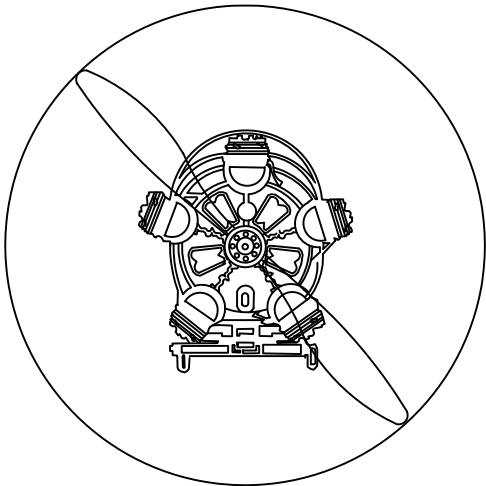
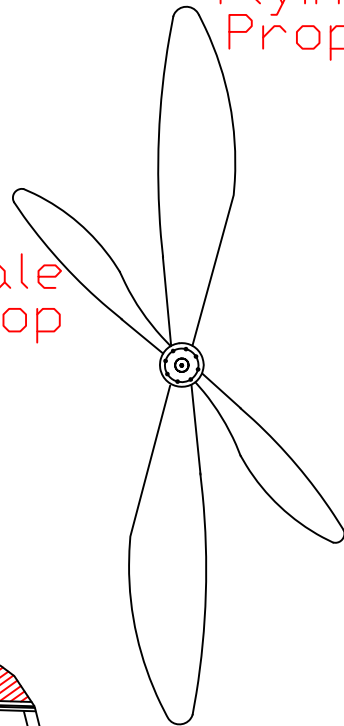
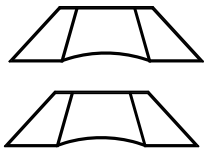

Wind Screens

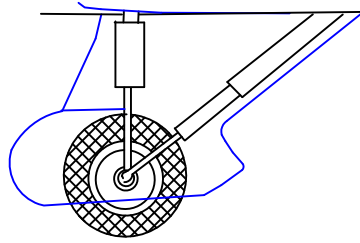
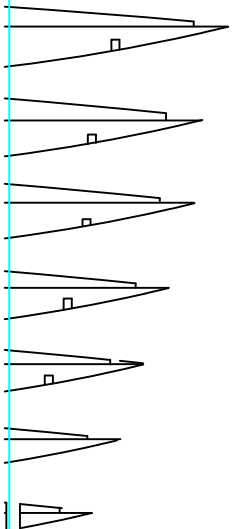
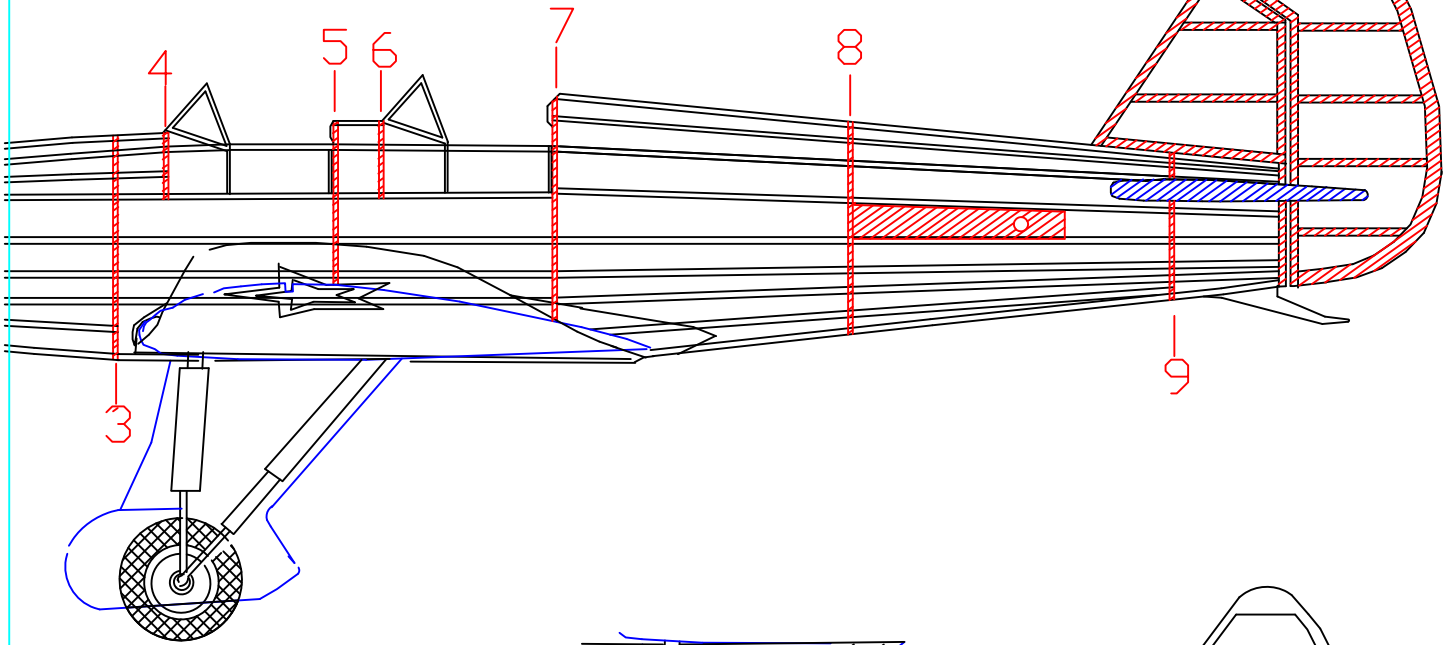

Scale

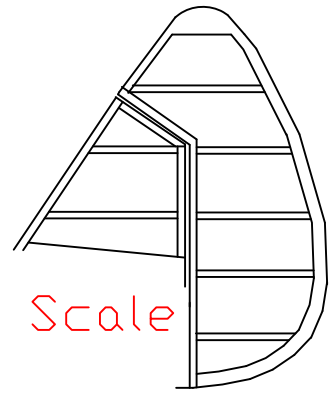

Scale

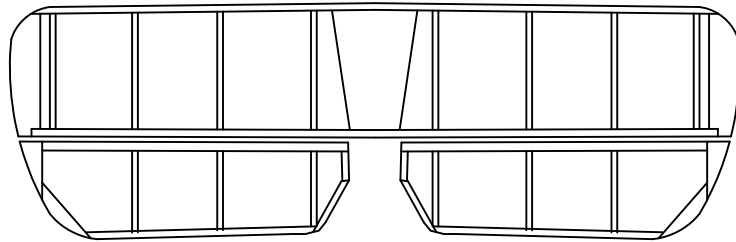
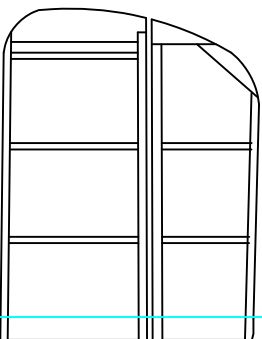

Scale

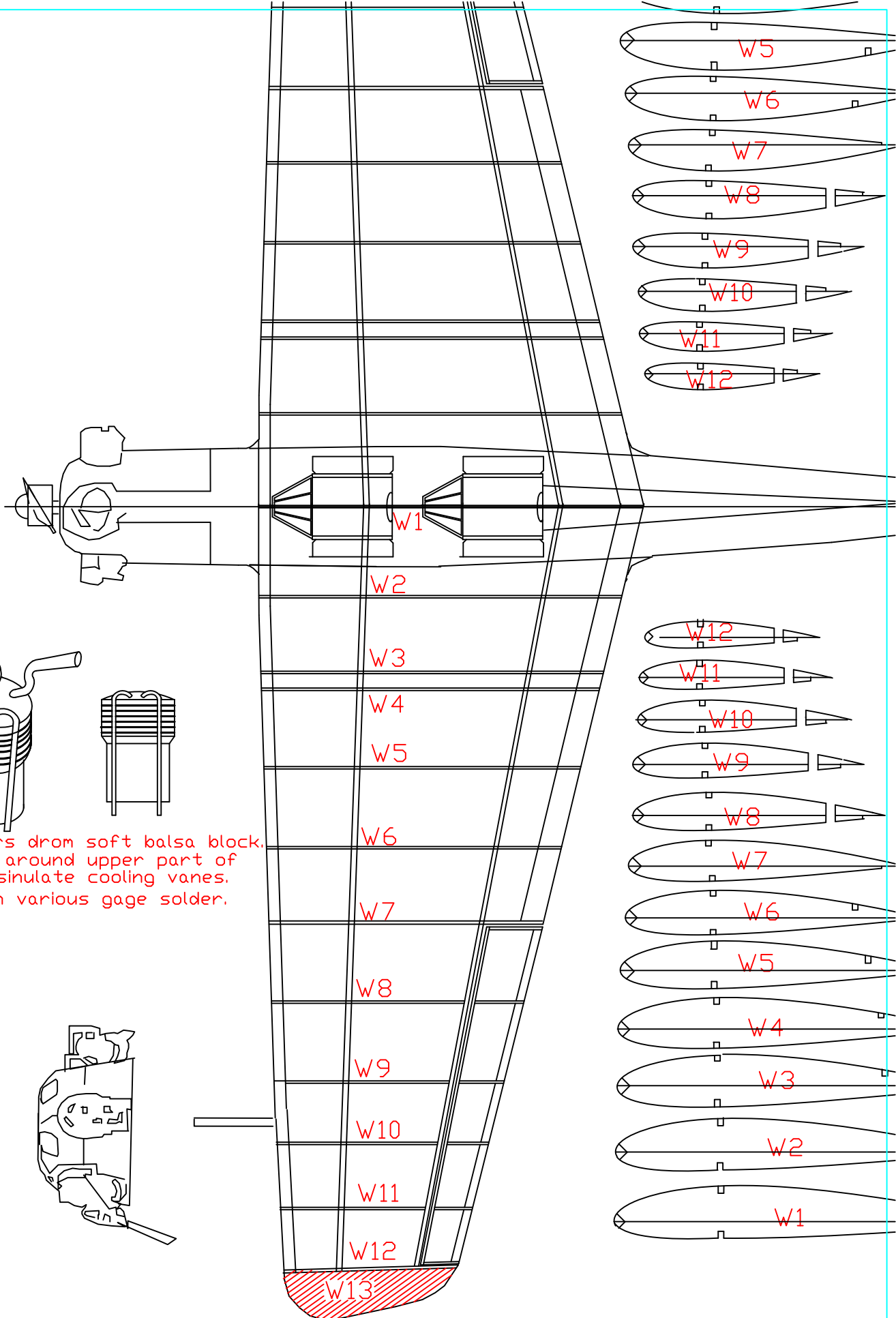

Carve cylinders drom soft balsa block.
 Wrap thread around upper part of
 cylinder tosinulate cooling vanes.
 Pipes from various gage solder.

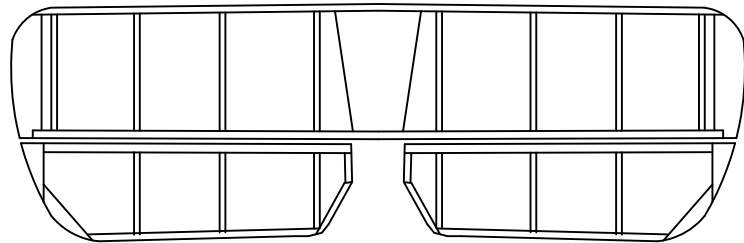
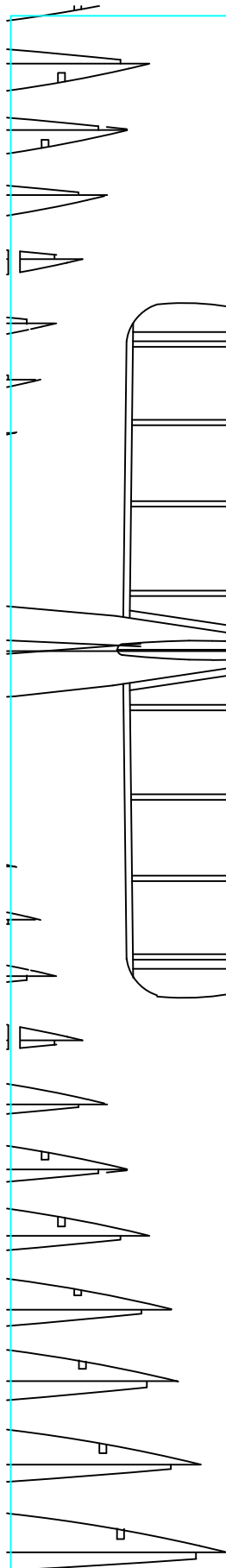

Scale

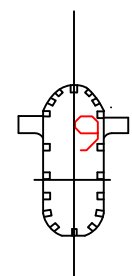
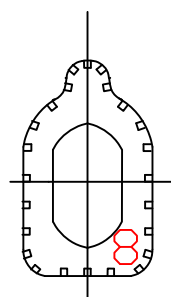
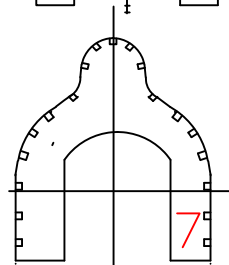
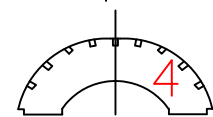
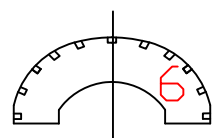
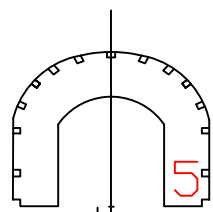
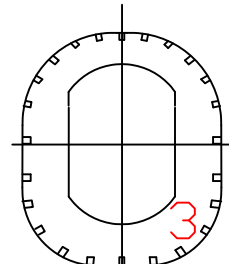
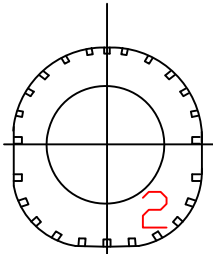
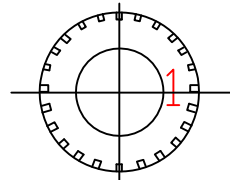
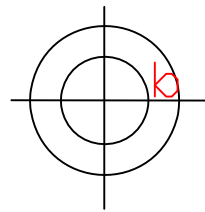
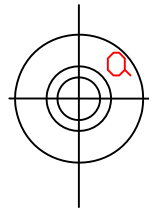
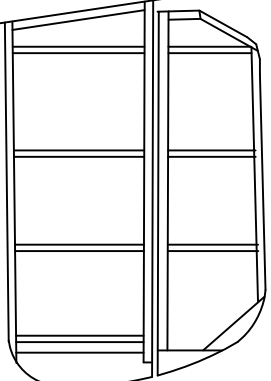
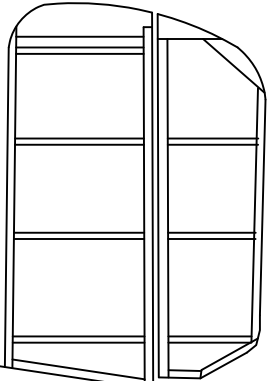

Yakovlev UT-2 Mink